

PROPERTY / EVIDENCE REPORT

VENTURA COUNTY SHERIFF'S DEPARTMENT

AGENCY IDENTIFIER CA0560000

Page 1 of 1

1 CONNECTING REPORT NUMBERS		2 RD 3262	3 BEAT 3C02	4 RB NUMBER 03-08235		
5 PROPERTY TYPE: <input checked="" type="checkbox"/> EVIDENCE <input type="checkbox"/> FOUND <input type="checkbox"/> SAFEKEEPING		6 <input type="checkbox"/> Misdemeanor <input checked="" type="checkbox"/> Felony		7 DATE OF INCIDENT 3-20-2003		
8 INCIDENT / OFFENSE(S) (List all probable cause offenses pertaining to this RB.) 417(c) PC / Officer Involved Shooting		9 LOCATION OF INCIDENT (STREET ADDRESS AND CITY) Mugu State Beach				
CODE: V - Victim S - Suspect A - Arrestee F - Finder O - Owner R - Reporting Party (Use Same Codes in Property Affiliation Boxes.)						
10 CODE V-1	11 NAME (Last, First, Middle, Gen.) / FIRM NAME Stephens, Jason	AKA / Moniker	RACE SEX 14 DOB	15 BUSINESS PHONE ()		
16 RESIDENCE ADDRESS / (<input type="checkbox"/> Same as Box # _____) Ventura County Sheriff's Deputy		CITY	STATE	ZIP		
17 RESIDENCE PHONE (805) 388-5100						
18 CODE V-2	19 NAME (Last, First, Middle, Gen.) / FIRM NAME Cerio, Steven	AKA / Moniker	RACE SEX 22 DOB	23 BUSINESS PHONE ()		
24 RESIDENCE ADDRESS / (<input type="checkbox"/> Same as Box # _____) Ventura County Sheriff's Deputy		CITY	STATE	ZIP		
25 RESIDENCE PHONE (805) 654-9511						
26 CODE S-1	27 NAME (Last, First, Middle, Gen.) / FIRM NAME Perlman, Nancy	AKA / Moniker	RACE SEX 30 DOB	31 BUSINESS PHONE (N/A)		
32 RESIDENCE ADDRESS / (<input type="checkbox"/> Same as Box # _____) Deceased		CITY	STATE	ZIP		
33 RESIDENCE PHONE (N/A)						
34 NARRATIVE						
On 10-23-06, [REDACTED] (deceased's husband) brought a compact disk to the Ventura County District Attorney's Office and played it. DA Investigator Robert Briner made a copy of [REDACTED] CD (item #2) and forwarded it to me to be booked into evidence. I recorded my 10-23-06 interview of [REDACTED] (item #1) and booked it into evidence.						
35 PROPERTY / EVIDENCE INFORMATION						
LOCATION BOOKED: <input checked="" type="checkbox"/> Ventura E.C. _____		SEARCH WARRANT ? Yes <input checked="" type="checkbox"/> No		FINDER WISHES TO CLAIM? <input checked="" type="checkbox"/> No		
36 PROPERTY CLASSIFICATION CODES E - EVIDENCE SK - SAFEKEEPING RC - RECOVERED PROPERTY FP - FOUND PROPERTY		PROPERTY CODES A - CURRENCY/NOTES B - JEWELRY/PRECIOUS METALS C - CLOTHING/FURS D - VEHICLE E - OFFICE EQUIPMENT F - ELECTRONIC EQUIPMENT G - FIREARMS H - HOUSEHOLD GOODS I - CONSUMABLE GOODS J - LIVESTOCK K - MISCELLANEOUS				
CODE	ITEM #	QTY	ITEM NAME	MAKE	MODEL / CALIBER	ID / SERIAL NUMBER
E K	1	1	Recorded interview of [REDACTED] DDA	Bill Haney, DA Inv	Briner and myself	
PROP.AFFIL ADDITIONAL INFORMATION						
CODE	ITEM #	QTY	ITEM NAME	MAKE	MODEL / CALIBER	ID / SERIAL NUMBER
E K	2	1	Compact Disk recording provided by [REDACTED]			on 10-23-06.
PROP.AFFIL ADDITIONAL INFORMATION						
CODE	ITEM #	QTY	ITEM NAME	MAKE	MODEL / CALIBER	ID / SERIAL NUMBER
PROP.AFFIL ADDITIONAL INFORMATION						
37 DATE AND TIME OF REPORT 10/25/06/ 9:20 AM		38 REPORTING OFFICER / ID NO. / DIV / UNIT Sgt. M. Powers/#1365/Special Services			39 APPROVED BY / ID NO. [Signature]	
40 COPIES TO <input type="checkbox"/> DET / MC <input type="checkbox"/> NARC <input type="checkbox"/> GANG / SEU <input type="checkbox"/> STATS <input type="checkbox"/> PRESS <input type="checkbox"/> DOJ <input type="checkbox"/> COURT <input type="checkbox"/> OTHER						

NARRATIVE REPORT VENTURA COUNTY SHERIFF'S DEPARTMENT

Page 1 of 2

Continuation

AGENCY IDENTIFIER CA0560000

1 RD
3261

2 BEAT
3C02

3 RB NUMBER
03-08235

4	5	6	7	8	9	10	11	12
ITEM	QTY.	ITEM NAME	BRAND / MAKE MANUFACTURER	MODEL NAME OR NUMBER	MISC. DESCRIPTION	IDENTIFICATION / SERIAL NUMBER	VALUE	

- Supplemental Case Cleared
 Gang Domestic Hate Child Abuse Elderly Abuse

Connecting Report Numbers:

Code Section / Description: Office Involved Shooting Death

Reclassify to:

Code: S-1 **Name:** Pearlman, Nancy

Follow-up with

[REDACTED] on October 30, 2006

On 10-23-06, I told [REDACTED] that I would check with my superiors in an attempt to accommodate his request to view the photographs of the crime scene, in particular the window of the vehicle Nancy Perlman was driving when she was shot. On 10-23-06, I received the following e-mail from [REDACTED]

From: [REDACTED]
To: [REDACTED]
Date: 10/23/2006 6:05 PM
Subject: Case Closed
CC: "Linda Parks" <Linda.Parks@ventura.org>, "Gary Auer" <Gary.Auer@vent... 10/23/2006 5:59 PM
 I spent 2 hours with the DA and Sheriffs department today and heard the original tape and the transcription was correct. I heard the enhanced version on the DA's equipment and it made a huge difference. Based on what I heard the officer in fact told her to put down the gun. Should they have shot her no! However, based on what I saw today and heard there was provocation. I am satisfied that the DA and Sheriffs did not cover up anything and the final report is correct. I wish to thank Supervisor, Linda Parks; Gary Auer, DAA, Rob Briner, DAA as well as the investigating DAA and Sergeant Mike Powers for their assistance in bring closure for me in this matter. I can now go on with my life.

On 10-26-06, I contacted Captain [REDACTED] and he authorized [REDACTED] to view the photographs of the crime scene at the Major Crimes office.

13 DATE / TIME OF REPORT 10-30-06 / 1315	14 REPORTING OFFICER / ID NO / DIV / UNIT Sgt. M. Powers/#1365/Special Services	15 APPROVED BY / ID NO Capt. L. [REDACTED] #1822
---------------------------------------------	------------------------------------------------------------------------------------	-----------------------------------------------------

NARRATIVE REPORT VENTURA COUNTY SHERIFF'S DEPARTMENT

Page 1 of 6

Continuation

AGENCY IDENTIFIER CA0560000

1 RD 3261	2 BEAT 3C02	3 RB NUMBER 03-08235
--------------	----------------	-------------------------

4 CODE	5 ITEM	6 QTY.	7 ITEM NAME	8 BRAND / MAKE MANUFACTURER	9 MODEL NAME OR NUMBER	10 MISC. DESCRIPTION	11 IDENTIFICATION / SERIAL NUMBER	12 VALUE
--------	--------	--------	-------------	-----------------------------	------------------------	----------------------	-----------------------------------	----------

- Supplemental Case Cleared
 Gang Domestic Hate Child Abuse Elderly Abuse

Connecting Report Numbers:

Code Section / Description: Office Involved Shooting Death

Reclassify to:

Code: S-1 **Name:** Pearlman, Nancy

Compact Disk

Presented to the Ventura County District Attorney's Office by

[REDACTED] on October 23, 2006

On 10-2-06, Senior Deputy District Attorney Bill Haney sent me the following e-mail:

*Mike,
I didn't retain my [REDACTED] tapes. Apparently, [REDACTED] is claiming that my report re what is on Deputy Cerio's tape is inaccurate. I recall listening to the tape over and over again and heard what was in VSO's report. Pearlman has hired an audio expert. Can you send me over a copy of Cerio's recording at the scene?
--Bill*

I went to the Sheriff's Property Room and checked item #21, Deputy Cerio's micro-cassette tape out of evidence. On 10-13-06, I opened the evidence envelope and duplicated the recording onto a standard size cassette tape to give to DDA Haney. After making the copy, I listened to the copy and could hear that it was of lesser quality than the original micro-cassette. On 10-17-06, I took the copy and the original micro-cassette to DDA Haney's office, where we both listened to the micro-cassette tape and confirmed that the Sheriff's report was accurate. After playing the micro-cassette tape for DDA Haney I booked it back into evidence in the Ventura Property Room. From the time I checked the tape out of evidence, until the time I checked it back into evidence, the tape remained in the evidence locker at the Major Crimes Bureau when it was not in my possession.

On 10-23-06, I received a phone call from DDA Haney, who told me that [REDACTED] was in his office and played a CD copy of Cerio's micro-cassette tape, with a drastic difference. DDA

13 DATE / TIME OF REPORT 10-24-06 / 1748	14 REPORTING OFFICER / ID NO / DIV / UNIT Sgt. M. Powers/#1365/Special Services	15 APPROVED BY / ID NO Capt. L. [REDACTED] #1822
---------------------------------------------	------------------------------------------------------------------------------------	-----------------------------------------------------

NARRATIVE REPORT VENTURA COUNTY SHERIFF'S DEPARTMENT

Page 2 of 6

Continuation

AGENCY IDENTIFIER CA0560000

1 RD
3261

2 BEAT
3C02

3 RB NUMBER
03-08235

4 CC	5 ITEM	6 QTY.	7 ITEM NAME	8 BRAND / MAKE MANUFACTURER	9 MODEL NAME OR NUMBER	10 MISC. DESCRIPTION	11 IDENTIFICATION / SERIAL NUMBER	12 VALUE
------	--------	--------	-------------	-----------------------------	------------------------	----------------------	-----------------------------------	----------

Haney asked me to check out Cerio's original micro-cassette and bring it to his office so he, DA Chief Deputy Investigator Robert Briner and [REDACTED] could hear the two recordings.

I checked the tape, evidence item #21, back out of evidence and took it to DDA Haney's office where he, DA Investigator Briner and [REDACTED] were located in a conference room.

I turned on my digital recorder on 10-23-06 at 1544 hours, and notified everyone in the room I was recording the conversation and recorded the following:

I verbally identified myself as well as the others in the conference room verbally identifying themselves. I explained that I was at the DA's office because [REDACTED] had brought a recording to the DA's office to play the recording for DDA Haney. I explained the background stated in the above paragraphs.

Next I played Deputy Cerio's original micro-cassette recording for DDA Haney, DA Investigator Briner and [REDACTED]. As the recorder played [REDACTED] commented, "I [REDACTED]'t hear the [REDACTED]'t shoot' on there." DDA Haney said he heard (Deputy Stephens) say, "Put the gun down. [REDACTED] asked, "Did you hear her say, 'put the gun down?'" We continued playing the recording until shortly after the last shots were fired, because the rest of the tape was not in question. DDA Haney asked me to replay the recording from the beginning again.

I played Deputy Cerio's recording from the beginning again. [REDACTED] said, "I heard something." I commented (my understanding of what Deputy Stephens yelled) "Put the gun down." [REDACTED] then said, "um-hum" (affirmative).

Next I asked DDA Haney to play the CD [REDACTED] brought to his (Haney's) office. DDA Haney played the CD [REDACTED] brought to his office. In listening to the recording, I heard blank (no volume) breaks in the recording as though some of the portions of the recording did not record onto the CD and some of the words heard on the original recording were missing altogether or part of the word was missing when the breaks occurred.

13 DATE / TIME OF REPORT
10-24-06 / 1748

14 REPORTING OFFICER / ID NO / DIV / UNIT
Sgt. M. Powers/#1365/Special Services

15 APPROVED BY / ID NO
Capt. L. [REDACTED] #1822

NARRATIVE REPORT VENTURA COUNTY SHERIFF'S DEPARTMENT

Page 3 of 6 Continuation

AGENCY IDENTIFIER CA0560000

1 RD 3261	2 BEAT 3C02	3 RB NUMBER 03-08235
--------------	----------------	-------------------------

4 CP	5 ITEM	6 QTY.	7 ITEM NAME	8 BRAND / MAKE MANUFACTURER	9 MODEL NAME OR NUMBER	10 MISC. DESCRIPTION	11 IDENTIFICATION / SERIAL NUMBER	12 VALUE
---------	-----------	-----------	----------------	-----------------------------------	------------------------------	----------------------------	-----------------------------------------	-------------

At 8 minutes 19 seconds into my digital recording, after Deputy Cerio asked Nancy to roll down the window and a dispatcher can be heard saying the subject (Nancy Perlman) was refusing to come out, I heard Deputy Cerio say "Nancy!" Then I heard another different sounding male voice I had never heard before say, "█'t shoot." When the other voice said "█'t shoot" there was a definite break in the background noise (no background noise) from the original tape. The portion of the recording that has the, "█'t shoot" on it, has absolutely no background noise on it at all. As soon as the "█'t shoot" statement is made, the background noise returns and the recording is generally consistent with the rest of Deputy Cerio's original micro-cassette recording, but of lesser quality (similar to the quality of the standard size tape I recorded for DDA Haney on 10-13-06).

Based on what I heard, the "█'t shoot" portion appeared to be inserted over the original recording. Based on where I heard the "█'t shoot" statement inserted, an attempt is being made to alter the recording to make it sound like Deputy Cerio said, "Nancy, █'t shoot!" DDA Haney again stopped the recording shortly after the last shots were fired, as there were no issues raised by █ over the remainder of the recording.

I asked █ where he got that recording. █ said the original copy of the tape was subpoenaed by his attorney and then sent it to a forensic lab in San Francisco to be enhanced. I asked █ if he heard a distinct difference between his CD and Deputy Cerio's original micro-cassette. █ said he did. █ said there was a second track on the CD, which had the entire enhanced version of the recording (enhanced by the forensic lab), but he could not get that track to play on DDA Haney's portable CD player today. DDA Haney played the second track of the CD and it repeated (until it was turned off) Deputy Stephens' commands and then his first shots. █ explained that track 2 had the entire recording but was clearer than the first track on the tape.

█ commented that in the version I played on the micro-cassette he noticed there was no "clicking on an off" (breaks in the recording I described above) like he heard on the CD

13 DATE / TIME OF REPORT 10-24-06 / 1748	14 REPORTING OFFICER / ID NO / DIV / UNIT Sgt. M. Powers/#1365/Special Services	15 APPROVED BY / ID NO Capt. L. █ #1822
---------------------------------------------	------------------------------------------------------------------------------------	--------------------------------------------

NARRATIVE REPORT VENTURA COUNTY SHERIFF'S DEPARTMENT

Page 4 of 6

Continuation

AGENCY IDENTIFIER CA0560000

1 RD
3261

2 BEAT
3C02

3 RB NUMBER
03-08235

4 CASE	5 ITEM	6 QTY.	7 ITEM NAME	8 BRAND / MAKE MANUFACTURER	9 MODEL NAME OR NUMBER	10 MISC. DESCRIPTION	11 IDENTIFICATION / SERIAL NUMBER	12 VALUE
--------	--------	--------	-------------	-----------------------------	------------------------	----------------------	-----------------------------------	----------

version. DA Investigator Briner asked [REDACTED] about the process by which the audio was enhanced. [REDACTED] said he was not present during any portion of the enhancement. [REDACTED] explained that he was never in the chain of custody from when the recording was received from the Sheriff's Department. [REDACTED] said he never heard the audio cassette (from the Sheriff's Department) before it was copied onto a CD. [REDACTED] said his attorney made him a copy of the recording onto the CD; his copy being a third generation copy, and that was why we were probably hearing the "clicking."

I asked [REDACTED] "Are we all in agreement that this version that you've got is significantly different from the version that I just played?" [REDACTED] replied, "It is." I asked, "Does anyone hear in the version I just played, 't shoot'?" [REDACTED] replied, "I t hear that." [REDACTED] continued, "And again, for the record, I t hear any clicking and it's straight through where as the CD versions you've provided, you do hear the distinct clicking (inaudible). Now it'd be interesting to get the tape from my attorney, who won't release it." [REDACTED] said his attorney would not release the tape (provided by the Sheriff's Department) to him.

DDA Haney said that he appreciated [REDACTED] bringing (his CD) recording to his (DDA Haney's) attention. I asked if anyone else wanted to listen to the micro-cassette again. [REDACTED] said, "I t think I need to. It's clearly different than what was presented to me." DA Investigator Briner commented that you t hear the "t shoot" remark on the micro-cassette. DDA Haney said it was his intention to have an accurate report and invited [REDACTED] to forward anything else he felt needed to be considered to him (DDA Haney) and he would consider it. [REDACTED] said he would still like to see the photographs (taken by the Sheriff's Department) and DDA Haney referred him to me. I told [REDACTED] that I would have to discuss the matter with my superiors. [REDACTED] said (Ventura County) Supervisor Linda Parks became involved because there was no (civil) litigation forthcoming because the statute of limitation had expired. [REDACTED] said he just wanted to get answers to what was going on and "be e with this."

13 DATE / TIME OF REPORT 10-24-06 / 1748	14 REPORTING OFFICER / ID NO / DIV / UNIT Sgt. M. Powers/#1365/Special Services	15 APPROVED BY / ID NO Capt. L. [REDACTED] #1822
---------------------------------------------	------------------------------------------------------------------------------------	-----------------------------------------------------

NARRATIVE REPORT VENTURA COUNTY SHERIFF'S DEPARTMENT

Page 5 of 6 Continuation

AGENCY IDENTIFIER CA0560000

1 RD 3261	2 BEAT 3C02	3 RB NUMBER 03-08235
--------------	----------------	-------------------------

4 CODE	5 ITEM	6 QTY.	7 ITEM NAME	8 BRAND / MAKE MANUFACTURER	9 MODEL NAME OR NUMBER	10 MISC. DESCRIPTION	11 IDENTIFICATION / SERIAL NUMBER	12 VALUE
--------	--------	--------	-------------	-----------------------------	------------------------	----------------------	-----------------------------------	----------

I explained that I did not personally have any objections with showing him the photos because I felt we did a proper investigation and forwarded the case to the District Attorney so they could come to the proper conclusion, but the decision to show him the photos was not up to me. [REDACTED] said he did hear a phrase on the tape where someone possibly said something like "t shoot" or "oh shit" but after the segment we played. I concurred with [REDACTED] that I heard something like that and after reviewing the tape, after Deputy Cerio said (broadcast via radio) "Shots fired, shots fired, need assistance, car rolling," I heard him say in a lower volume "Oh shit."

I explained to [REDACTED] that the micro-cassette I played for him today was the original micro-cassette that Deputy Cerio had in his belt on the night of the shooting. I explained to [REDACTED] the reason I played the original micro-cassette to DDA Haney (on 10-17-06) I noticed that the quality of the copy was not as good as the original tape. [REDACTED] commented again that the recordings (CD and micro-cassette) were "significantly different."

[REDACTED] said that hearing the micro-cassette makes a lot of difference to him. [REDACTED] said the only other thing he wanted to do was to see the photos of the window. [REDACTED] gave me a phone number where I could reach him, [REDACTED] said he would be moving within the next three weeks and all his contact information would be void at that time. I told [REDACTED] I would contact my superiors and then contact him within the next week.

DA Investigator Briner handed me a piece of paper (attached to this report) with the name of "Audio Forensic" with an address of 130 Sutter Street, San Francisco, CA 94104, Phone (415) 397-0442. The letter was dated May 13, 2004 and addressed to [REDACTED] at his residence address in [REDACTED]. The letter was from [REDACTED] and was regarding [REDACTED]. The letter stated there was a compact disk enclosed that contained the first 33 minutes of side A, tape Q1 supplied in connection with the above referenced case. And 2) enhancement of speech on Q1 from 1:47-1:19, just prior to gunshot; repeated 5 times.

13 DATE / TIME OF REPORT 10-24-06 / 1748	14 REPORTING OFFICER / ID NO / DIV / UNIT Sgt. M. Powers/#1365/Special Services	15 APPROVED BY / ID NO Capt. L. [REDACTED] #1822
---------------------------------------------	------------------------------------------------------------------------------------	-----------------------------------------------------

NARRATIVE REPORT VENTURA COUNTY SHERIFF'S DEPARTMENT

Page 6 of 6

Continuation

AGENCY IDENTIFIER CA0560000

1 RD
3261

2 BEAT
3C02

3 RB NUMBER
03-08235

4 CODE	5 ITEM	6 QTY.	7 ITEM NAME	8 BRAND / MAKE MANUFACTURER	9 MODEL NAME OR NUMBER	10 MISC. DESCRIPTION	11 IDENTIFICATION / SERIAL NUMBER	12 VALUE
--------	--------	--------	-------------	-----------------------------	------------------------	----------------------	-----------------------------------	----------

██████████ allowed DA Investigator Briner to copy the CD he had brought to the District Attorney's Office today. DA Investigator Briner provided me a copy of ██████████ CD and I booked it along with the CD of this interview into evidence in this case.

On 10-23-06, I received the following e-mail from ██████████ :

From: ██████████
To: ██████████
Date: 10/23/2006 6:05 PM
Subject: Case Closed
CC: "Linda Parks" <Linda.Parks@ventura.org>, "Gary Auer" <Gary.Auer@vent... 10/23/2006 5:59 PM
I spent 2 hours with the DA and Sheriffs department today and heard the original tape and the transcription was correct. I heard the enhanced version on the DA's equipment and it made a huge difference. Based on what I heard the officer in fact told her to put down the gun. Should they have shot her no! However, based on what I saw today and heard there was provocation. I am satisfied that the DA and Sheriffs did not cover up anything and the final report is correct.
 I wish to thank Supervisor, Linda Parks; Gary Auer, DAA, Rob Briner, DAA as well as the investigating DAA and Sergeant Mike Powers for their assistance in bring closure for me in this matter.
 I can now go on with my life.

13 DATE / TIME OF REPORT 10-24-06 / 1748	14 REPORTING OFFICER / ID NO / DIV / UNIT Sgt. M. Powers/#1365/Special Services	15 APPROVED BY / ID NO Capt. L. ██████████ #1822
---------------------------------------------	------------------------------------------------------------------------------------	-----------------------------------------------------





130 Sutter Street
Fifth Floor
San Francisco
California
94104

TEL 415.397.0442
FAX 415.397.0454
e-mail info@audioforensics.com
www.audioforensics.com

TRANSMITTAL

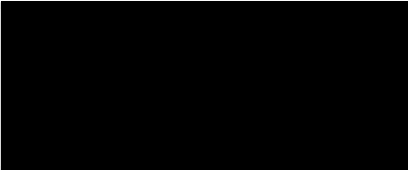
DATE: May 13, 2004

TO: 

FROM: 
Director, Audio Forensic Center

RE: 

Please find enclosed a compact disc with two tracks;

1) first 33 minutes of side A, tape Q1, supplied in connection with the above-referenced case

2) enhancement of speech on Q1 from 1:47-1:49, just prior to gunshot; repeated 5 times.

NARRATIVE REPORT VENTURA COUNTY SHERIFF'S DEPARTMENT

Page 1 of 1

Continuation

AGENCY IDENTIFIER CA0560000

1 R.D. 3262	2 BEAT 3C2	3 RB NUMBER 03-8235
----------------	---------------	------------------------

4 CODE	5 ITEM	6 QTY.	7 ITEM NAME	8 BRAND / MAKE MANUFACTURER	9 MODEL NAME OR NUMBER	10 MISC. DESCRIPTION	11 IDENTIFICATION / SERIAL NUMBER	12 VALUE
--------	--------	--------	-------------	-----------------------------	------------------------	----------------------	-----------------------------------	----------

Supplemental Case Cleared

Gang Domestic Hate Child Abuse Elderly Abuse

Connecting Report Numbers:

Code Section / Description: OFFICER INVOLVED SHOOTING

Code: S-1 Name: PEARLMAN, NANCY

The case was reviewed by DDA Bill Haney. DDA Haney concluded Senior Deputy Stephens acted reasonably and in self-defense under the circumstances, therefore, the District Attorney concludes the shooting of Nancy Pearlman was a justifiable homicide.

CASE CLOSED

13 DATE / TIME OF REPORT 03/09/04 / 16:16	14 REPORTING OFFICER / ID NO / DIV / UNIT E. Montagna #1047 / Sgt.	15 APPROVED BY / ID NO <i>[Signature]</i> 0027
----------------------------------------------	-----------------------------------------------------------------------	---------------------------------------------------

Copy to Sgt. Montagna

1 PETER M. WILLIAMSON, State Bar No. 97309
2 BAKER, JACOBS & ORING
3 13915 Panay Way, Suite One
4 Marina del Rey, CA 90292
5 Tel: (310) 822-3377
6 Fax: (310) 821-7027

7 Attorneys for Plaintiff [redacted]
8 individually, and as the Personal Representative of
9 NANCY PEARLMAN, Deceased

10
11 **SUPERIOR COURT OF THE STATE OF CALIFORNIA**
12 **FOR THE COUNTY OF VENTURA**

13 [redacted] individually, and as
14 the Personal Representative of NANCY
15 PEARLMAN, Deceased,

16 Plaintiff,

17 vs.

18 COUNTY OF VENTURA, VENTURA
19 COUNTY SHERIFF'S DEPARTMENT,
20 and DOES 1 through 50, inclusive,

21 Defendants.

CASE NO.: CIV 223759
Complaint Filed: 11/18/03
[Assigned for all purposes to Judge Steven
Hintz - Department "32"]

**REQUESTS FOR IDENTIFICATION
AND PRODUCTION OF DOCUMENTS
AND OTHER TANGIBLE THINGS
TO DEFENDANT COUNTY OF VENTURA
[Set No. One]**

22 PROPOUNDING PARTY: Plaintiff, [redacted]

23 RESPONDING PARTY: Defendant, COUNTY OF VENTURA

24 SET NUMBER: ONE

25 TO: DEFENDANT COUNTY OF VENTURA AND TO ITS ATTORNEYS OF RECORD:

26 Plaintiff, [redacted] hereby requests that Defendant, COUNTY OF VENTURA,
27 and its attorneys, produce and permit Plaintiff and his attorneys to inspect and copy each of the
28 documents described below at 10:00 a.m., on February 10, 2004, at the BAKER, JACOBS & ORING,
13915 Panay Way, Suite One, Marina del Rey, CA 90292.

Pursuant to Code of Civil Procedure § 2031 within thirty (30) days after service upon you of this
Request, you are required to serve upon Plaintiff a written response to this Request, subscribed under

FILE COPY

Ky...

1 oath by you.

2 The items to be produced are currently in the possession, custody or control of Defend[redacted] are
3 not privileged, and are relevant to the subject matter of this action, or reasonably calculated to lead to
4 the discovery of admissible evidence in this action.

5 **DEFINITIONS**

6 Unless the context clearly indicates otherwise, the following words and phrases are defined and
7 used herein as follows:

- 8 A. "YOU" and "YOURS" refers to Defend[redacted], COUNTY OF VENTURA.
- 9 B. "DECEDENT" refers to the shooting victim, Nancy Pearlman.
- 10 C. "INCIDENT" includes the circumstances and events surrounding the stop, detention and
11 shooting of decedent, Nancy Pearlman, that occurred on March 20, 2003, giving rise to this action.
- 12 D. "COMMUNICATION" means, unless otherwise specified, any of the following:
13 (1) any letter, memorandum or other document exchanged, received, or transmitted;
14 (2) any oral conversation between two or more persons, whether such conversation
15 was by chance or pre-arranged, formal or informal, by telephone or in person;
16 (3) any meeting between two or more persons, whether such contact was by chance
17 or pre-arranged, formal or informal, or
18 (4) any document summarizing or describing such document, exchange, oral
19 communication or meeting.
- 20 E. "DOCUMENT" means all written, typewritten, printed, recorded or graphic matters,
21 however produced or reproduced, whether draft or final, whether signed or unsigned. This definition
22 includes any and all of the following: papers; records; notes; summaries; schedules; press releases;
23 reports; memoranda of telephone or in-person c[redacted]rsation by or with any person; letters; telegrams;
24 telexes; tapes; transcripts; recordings; photographs; pictures; films; computer programs; data printouts;
25 discs; any kind of electronically or mechanically recorded materials; or any other graphic, symbolic,
26 recorded or written materials of any nature whatsoever. Any copy of a document which contains any
27 comments, notations, addition, insertion, or marking of any kind is to be considered a separate document.

28 ////////////////

1 **F. "EVIDENCE"** means and refers to testimony, material objects, or other things presented
2 to the senses that may be offered to prove the existence or nonexistence of a fact, and all writings and
3 other things included in the original and any copy of any written, recorded, filmed or graphic matter,
4 whether produced or reproduced on papers, cards, tapes, film, electronic facsimile, computer storage
5 devices or any other media, including, but not limited to, writings (as defined in California *Evidence*
6 *Code* § 250), memoranda, notes, minutes, records, photographs, movies, video-tapes, audio recordings,
7 correspondence, telegrams, telexes, diaries, bookkeeping entries, financial statements, tax returns,
8 checks, check stubs, reports, studies, charts, graphs, statements, notebooks, handwritten notes, plans,
9 architectural drawings, applications, proposals, agreements, books, pamphlets, articles, leaflets,
10 appointment calendars, work papers, and notes, records and recordings of oral conversations.

11 **G. "PERSON"** means and refers to any natural person, individual, corporation, partnership,
12 proprietorship, joint venture, governmental entity, and any other public or private entity.

13 **H. If any privilege is claimed as to any information requested in the Request for Production**
14 **of Documents:**

15 (1) State the nature of the privilege claimed (i.e., attorney-client, work product, etc.);
16 (2) State the name of the Party claiming the privilege and the name of the attorney,
17 if any, with respect to whom the privilege is claimed;

18 (3) State the facts upon which you rely as the basis for claiming the privilege as to
19 the specific information or document;

20 (4) Identify all persons present at any communications to which privilege is claimed
21 and all persons to whom the subject matter of the communication was discussed or disclosed; and

22 (5) State the date of each such communication.

23 **I. If any privilege is claimed as to any document requested or sought to be identified herein:**

24 (1) State the nature of the privilege claimed (i.e., attorney-client, work product, etc.);

25 (2) State the name of the Party claiming the privilege and the name of the attorney,
26 if any, with respect to whom the privilege is claimed;

27 (3) State the facts upon which you rely as the basis for claiming the privilege as to
28 the specific information or document;

1 11. Any and all communications, reports, memoranda, notes and other records of the
2 communications, observations and perceptions of each law enforcement officer and witness relative to
3 any act or omission, event or incident described in the underlying allegations of the complaint, including,
4 but not limited to 911 calls, MDT Records, Communication Incident Reports, communication tapes of
5 radio transmissions made between V.C.S.D. deputies, the V.C.S.D. Radio Dispatcher, and any and all
6 police officers involved in the incident.

7 12. Any and all Use of Force Reports written as a consequence of this incident.

8 13. Any and all Sargent's logs and other V.C. S.D. employes reports to supervisors, watch
9 commanders, or other higher authority with the V.C. S.D. regarding this incident.

10 14. Any and all oral or written statements and/or admissions allegedly made by the plaintiff,
11 whether signed or unsigned.

12 15. Any and all tape recordings of the plaintiff concerning this incident.

13 16. Any and all transcripts of written statements of the plaintiff concerning this incident.

14 17. Any and all notes or memoranda, handwritten or typed, by V.C.S.D. deputies or other
15 investigating officers of their conversations with the plaintiff.

16 18. Any and all notes or memoranda, handwritten or typed, by V.C.S.D. deputies or other
17 investigating officers of their conversations with any persons pertaining to the investigation of this
18 incident.

19 19. Any and all records, documents, memoranda or things containing information relating
20 to the medical needs of the decedent subsequent to her being shot.

21 20. All documents which reflect any statement made to the media, including, but not limited
22 to newspapers, television and radio by any officer or representative of the V.C.S.D. regarding the
23 shooting of decedent.

24 21. Copies of any and all manuals, policy statements, memorandum, training bulletins, and
25 other documents discussing "the use of deadly force" followed by the V.C. S.D. which have been in
26 existence for the five (5) years prior to the date of this incident.

27 ////////////////

28 ////////////////

1 22. Copies of any and all manuals, policy statements, memorandum, training bulletins, and
2 other documents discussing "contacts with mentally ill citizens" by the deputies of the V.C.S.D. which
3 have been in existence for the five (5) years prior to the date of this incident.

4 23. Copies of any and all manuals, policy statements, memorandum, training bulletins, and
5 other documents discussing the procedure for disciplining deputies of the V.C.S.D. accused of using
6 deadly or unreasonable force which have been in existence for the five (5) years prior to the date of this
7 incident.

8 24. Field Officer Training Manuals of the V.C.S.D. in effect on March 20, 2003.

9 25. Copies of any and all manuals, policy statements, memorandum, training bulletins, and
10 other documents of the V.C.S.D. in effect on March 20, 2003, governing or relating to the proper and
11 improper use and degree of force in effecting detentions or arrests.

12 26. All documents which refer or relate to any lawsuit naming as a defend[redacted] the County of
13 Ventura alleging the use of unnecessary, unreasonable, or excessive force or misuse of equipment
14 involving the use of force, or improper tactics involving the use of force, by any individual present
15 immediately before, during, and after the shooting of the decedent.

16 27. All reports of the investigation of the use of deadly force in this incident.

17 28. All reports of the investigation of the discharge of firearms in this incident.

18 29. Any and all reports, notes, memoranda, or other writings which reflect the investigation,
19 analysis, opinions and conclusions of any individual regarding the shooting of the decedent.

20 30. Any and all reports, notes, memoranda, or other writings which reflect the investigation,
21 analysis, opinions and conclusions of any outside consultant regarding the shooting of the decedent.

22 31. Any and all reports, notes, memoranda, or other writings by any entity within the
23 V.C.S.D., which investigated, analyzed or passed judgment regarding the shooting of the decedent.

24 32. Any and all documents and reports which reflect blood or chemical analysis performed
25 on the blood of the decedent as a result of the shooting of the decedent.

26 33. Any and all photographs and videotapes taken of any Sheriff's Deputy involved in the
27 shooting of the decedent. For purposes of this Request, photocopies of photographs will not be
28

1 acceptable. Plaintiff will pay the cost of reproducing any photographs produced in response to this
2 Request.

3 34. Any and all diagrams, models, reconstructions, or drawings of the scene of this incident.

4 35. All writings constituting diagrams or drawings of the scene of this incident. This request
5 includes scale diagrams and/or models of the shooting scene.

6 36. All videotapes regarding the subject shooting, including all walkthrough videotapes taken
7 of any and all Sheriff's Deputies involved in the shooting of the decedent. (Please provide complete
8 videotapes without deletion of any images or sound.)

9 37. All photographs regarding the subject shooting. This includes photographs of any item
10 of evidence, any officer involved in the shooting, the decedent, weapons involved in the shooting, the
11 weapon allegedly in the possession of the decedent at the time of the shooting, and the location of
12 decedent's vehicle relative to the position of the vehicles being driven by the Sheriff's Deputies involved
13 in the shooting of the decedent. For purposes of this Request, photocopies of photographs will not be
14 acceptable. Plaintiff will pay the cost of reproducing any photographs produced in response to this
15 Request.

16 38. All writings which constitute all investigations of the subject shooting, whether it be a
17 shots fired investigation, an officer-involved shooting investigation, or any another investigation into
18 the facts and circumstances of this incident.

19 39. All lab reports, ballistic reports, or any other forensic analysis concerning any and all
20 weapons in the possession Sheriff's Deputies involved in shooting of the decedent.

21 40. All lab reports, ballistic reports, or any other forensic analysis concerning any and all
22 weapons allegedly in the possession of the decedent at the time she was fatally shot.

23 41. All videotapes and photographs which evidence any reconstruction of the events of the
24 shooting of the decedent, including the placement of any of the involved parties and deputies, as well
25 as physical evidence. For purposes of this Request, photocopies of photographs will not be acceptable.
26 Plaintiff will pay the cost of reproducing any photographs produced in response to this Request.

27 //////////////

28 //////////////

1
2
3
4
5
6
7
8
9
10
11
12
13
14
15
16
17
18
19
20
21
22
23
24
25
26
27
28

42. All photographs and videotapes showing what the decedent was wearing at the time of the subject shooting. For purposes of this Request, photocopies of photographs will not be acceptable. Plaintiff will pay the cost of reproducing any photographs produced in response to this Request.

43. All evidence logs pertaining to this incident.

44. All reports, notes, memoranda, or any other documents in your possession generated by the Ventura County Coroner's Office regarding the physical inspection, autopsy, chemical or forensic analysis, or cause of death of the decedent.

DATED: January 5, 2004

BAKER, JACOBS & ORING

BY: 
PETER M. WILLIAMSON
Attorneys for Plaintiff

1
2
3
4
5
6
7
8
9
10
11
12
13
14
15
16
17
18
19
20
21
22
23
24
25
26
27
28

PROOF OF SERVICE

STATE OF CALIFORNIA }
COUNTY OF LOS ANGELES } ss

I am employed in the County of Los Angeles, State of California. I am over the age of eighteen and not a party to the within action; my business address is 13915 Panay Way, Suite One, Marina del Rey, California 90292.

On January 5, 2004, I served the foregoing document described as REQUEST FOR PRODUCTION OF DOCUMENTS TO DEFENDANT COUNTY OF VENTURA (Set No. One) on the interested parties in this action by placing in the U.S. mail, a true copy thereof enclosed in sealed envelopes with postage prepaid and addressed as follows:

██████████ P. KEIGHRON, Esq.
Law Offices of Alan E. Wisotsky
300 Esplanade Drive, Suite 1500
Oxnard, CA 93030

- () BY FACSIMILE: By successfully sending via facsimile to the above-reference fax number.
- (xx) BY MAIL: I caused such envelope to be deposited in the mail at Marina del Rey, California. The envelope was mailed with postage thereon fully prepaid.

I am "readily familiar" with the firm's practice of collection and processing correspondence for mailing. Under that practice it would be deposited with the U.S. postal service on the same day with postage thereon fully prepaid at Marina del Rey, California in the ordinary course of business. I am aware that on motion of the party served, service is presumed invalid if postal cancellation date or postage meter date is more than one day after date of deposit for mailing an affidavit.

I declare under penalty of perjury under the laws of the State of California, that the above is true and correct.

Executed on January 5, 2004, at Marina del Rey, California.

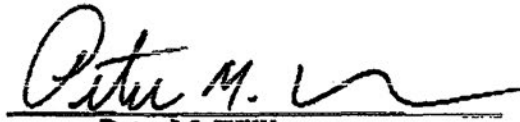
Peter M. Williamson

1 PETER M. WILLIAMSON, State Bar No. 97309
2 BAKER, JACOBS & ORING
3 13915 Panay Way, Suite One
4 Marina del Rey, CA 90292
5 Tel: (310) 822-3377
6 Fax: (310) 821-7027

7
8 Attorneys for Plaintiff [REDACTED]
9 individually, and as the Personal Representative of
10 NANCY PEARLMAN, Deceased

11 SUPERIOR COURT OF THE STATE OF CALIFORNIA
12 FOR THE COUNTY OF VENTURA

13 [REDACTED] individually, and as
14 the Personal Representative of NANCY
15 PEARLMAN, Deceased,

16 Plaintiff,

17 vs.

18 COUNTY OF VENTURA, VENTURA
19 COUNTY SHERIFF'S DEPARTMENT,
20 and DOES 1 through 50, inclusive,

21 Defendants.

CASE NO.: CIV 223759
Complaint Filed: 11/18/03
[Assigned for all purposes to Judge Steven
Hintz - Department "32"]

REQUESTS FOR PRODUCTION
OF OTHER TANGIBLE THINGS
TO DEFENDANT COUNTY OF VENTURA
[Set No. Two]

22 PROPOUNDING PARTY: Plaintiff [REDACTED]
23 RESPONDING PARTY: Defendant [REDACTED], COUNTY OF VENTURA
24 SET NUMBER: TWO

25 TO: DEFENDANT [REDACTED] COUNTY OF VENTURA AND TO ITS ATTORNEYS OF RECORD:

26 Plaintiff, [REDACTED], hereby requests that Defendant [REDACTED], COUNTY OF VENTURA,
27 and its attorneys, produce and permit Plaintiff and his attorneys to inspect the tangible thing described
28 below at 10:00 a.m., on February 10, 2004, at the BAKER, JACOBS & ORING, 13915 Panay Way,
Suite One, Marina del Rey, CA 90292, and continuing so long as reasonably required.

The following is the designation of tangible things to be produced for inspection as aforesaid:

//////

FILE COPY

1
2
3
4
5
6
7
8
9
10
11
12
13
14
15
16
17
18
19
20
21
22
23
24
25
26
27
28

Pursuant to Code of Civil Procedure § 2031 within thirty (30) days after service upon you of this Request, you are required to serve upon Plaintiff a written response to this Request, subscribed under oath by you.

The items to be produced are currently in the possession, custody or control of Defendant, are not privileged, and are relevant to the subject matter of this action, or reasonably calculated to lead to the discovery of admissible evidence in this action.

TANGIBLE THING TO BE PRODUCED

1. [REDACTED] License No. [REDACTED], VIN No. [REDACTED] owned and registered by Plaintiff [REDACTED]

DATED: January 5, 2004

BAKER, JACOBS & ORING

BY: 
PETER M. WILLIAMSON
Attorney for Plaintiff
[REDACTED]

1
2
3
4
5
6
7
8
9
10
11
12
13
14
15
16
17
18
19
20
21
22
23
24
25
26
27
28

PROOF OF SERVICE

STATE OF CALIFORNIA }
COUNTY OF LOS ANGELES } SS

I am employed in the County of Los Angeles, State of California. I am over the age of eighteen and not a party to the within action; my business address is 13915 Panay Way, Suite One, Marina del Rey, California 90292.

On January 5, 2004, I served the foregoing document described as REQUEST FOR INSPECTION TO DEFENDANT COUNTY OF VENTURA on the interested parties in this action by placing in the U.S. mail, a true copy thereof enclosed in sealed envelopes with postage prepaid and addressed as follows:

██████████ P. KEIGHRON, Esq.
Law Offices of Alan E. Wisotsky
300 Espianade Drive, Suite 1500
Oxnard, CA 93030

- () BY FACSIMILE: By successfully sending via facsimile to the above-reference fax number.
- (xx) BY MAIL: I caused such envelope to be deposited in the mail at Marina del Rey, California. The envelope was mailed with postage thereon fully prepaid.

I am "readily familiar" with the firm's practice of collection and processing correspondence for mailing. Under that practice it would be deposited with the U.S. postal service on the same day with postage thereon fully prepaid at Marina del Rey, California in the ordinary course of business. I am aware that on motion of the party served, service is presumed invalid if postal cancellation date or postage meter date is more than one day after date of deposit for mailing an affidavit.

I declare under penalty of perjury under the laws of the State of California, that the above is true and correct.

Executed on January 5, 2004, at Marina del Rey, California.

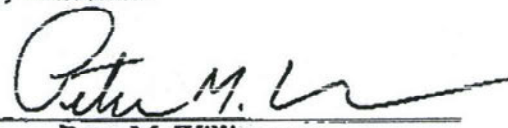
Peter M. Williamson

IA
654-2894

TABLE OF CONTENTS
03-8235

BOOK 1

A CASE SUMMARY

B CRIME REPORT

C SUPPLEMENTAL SUMMARY REPORT—includes Dep. Cerio’s interview

D ADDITIONAL SUPPLEMENTAL REPORTS

E SCENE DESCRIPTION WITH DIAGRAM--See large diagram for details

F SUSPECT INFORMATION

G SR. DEPUTY JASON STEPHENS’ PUBLIC SAFETY STATEMENT

H DEPUTY STEVE CERIO’S PUBLIC SAFETY STATEMENT

I SUMMARY TRANSCRIPTION OF DEPUTY CERIO’S RECORDING OF INCIDENT

J WITNESSES’ STATEMENTS

K [REDACTED] INTERVIEW (SUSPECT’S HUSBAND)

L MEDICAL EXAMINER’S REPORT & RELATED REPORTS

M FIREARMS’ INFORMATION

N EVIDENCE & BI REPORTS

O CRIME LAB REQUESTS

P VEHICLE REPORTS

Q ICS / INCIDENT LOG

R CALLS (DISPATCH) FOR SERVICE SUMMARY

S UNITS’ HISTORY & DAILY WORK SCHEDULE

T PROGRESS REPORT

U RELATED E-MAILS

V MEDIA REPORTS

BOOKS 2

PHOTOGRAPHS

AUDIO TAPES (copies)

...e also had sus-
...ed skull, beating
...shoulders and
...least 20 stab
...back of her neck

...ital organs were
...force the assail-
...Wotkyns caused
...to hit a bone and
...D'Halloran testi-
...blood and bruise-
...e bodies meant
...es' hearts were
...t the attacks,
...He could not
...whether the pair
...ed unconscious
...ks.

...Wotkyns, long-
...of a Camarillo
...company who
...their retirements,
...it-force trauma,
...Their injuries
...with the assail-
...ball bat and two
...knives, which,
...onte Carlo, were
...honorities.
...been charged as
...o counts of first-
...burglary, rob-

info
arre
ball
Ora
requ
ecut
pers
T
othe
ther
wer
dere
F
Nac
both
Ran
awa
2002
scio
tape
curr
del
was
ecut
a pc
sexu
neys
the s
T
nex
char
tenc

B
ff
fo
ih
p
of
sl
d
se
tr
m
te
of
P
C
T

...in the elbow a
...Perry was
...Wednesday a
...Medical Cent

Truck Kills 11

From a Times Staff

A 37-year-old man killed late Tuesday by a pickup truck in a park road in Ventura County, authorities said Tuesday. The driver of the vehicle was not cited. The driver of the truck, a 1997 Ford Taurus, was not cited. The driver of the truck, a 1997 Ford Taurus, was not cited. The driver of the truck, a 1997 Ford Taurus, was not cited.

Lottery R

For Wednesday, Nov. 11
Super Lotto Plus
Mega Number is Bold
2-17-29-44-47-N
Jackpot: \$42 million
Fantasy Five: 3-1-1-1-1
Daily Three (midweek)
Daily Three (evening)
Daily Derby:
(12) Lucky Charm
(5) California Class
(10) Solid Gold
Race Time: 1:42.
Results on the Internet:
www.latimes.com
General Information:
(800) 568-8379
(Results not available at this time.)

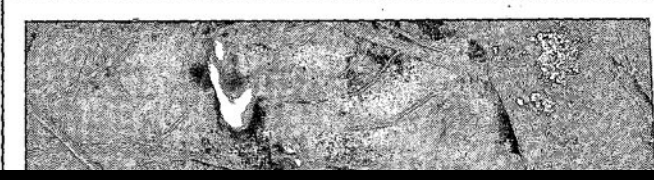

How to Res

VENTURA COUNTY SHERIFF'S DEPARTMENT

HOMICIDE SUMMAY

OFFICER INVOLVED SHOOTING / DEATH

REPORT #: 03-8235

INVESTIGATOR(S): Sgt. Ernie Montagna
Detective [REDACTED] Rivera

VICTIM: Sr. Deputy Jason Stephens #2743
Deputy Steve Cerio #3415

SUSPECT: Nancy Pearlman

DATE & TIME OCCURRED: 3/20/2003 / 1849

DATE & TIME REPORTED: 3/20/2003 / 1849

REPORTING PERSONS: [REDACTED] (Suspect's husband)

LOCATION: Mugu State Beach, Point Mugu
Parking lot area

CAUSE OF DEATH: Single gunshot wound to the head

WEAPON(S): 9 mm handguns

DISPOSITION: Case reviewed by DDA Bill Haney
Ruled justifiable homicide

CASE CLOSED

NARRATIVE:

On 3-20-2003, R/P [REDACTED] contacted the Ventura County Sheriff's Department and reported his wife, Suspect Nancy Pearlman, was suicidal and armed with a loaded 9mm semi-automatic handgun. The suspect was reported driving a [REDACTED] with California license plates of [REDACTED]. The R/P further stated the suspect might be enroute to the Mugu Rock beach area.

Patrol units responded to the R/P residence in Camarillo. The R/P reported the suspect has prior suicide attempts. The R/P told the deputies the

suspect removed a loaded handgun from a leather gun case, placed the opened gun case on a bed and put her cell-phone on top of the case. R/P indicated the suspect was telling him that she was going to kill herself and that he would be unable to contact / stop her. Dispatch broadcast the aforementioned information to patrol units.

Shortly thereafter, Sr. Deputy Jason Stephens was working uniform patrol as 3C51. At approximately 1920 hours, while on patrol on PCH in the area of Mugu Rock, Stephens radioed dispatch and advised he located the suspect's vehicle. A 10-33 was broadcast. Deputy Steve Cerio, working uniform patrol as 3D51, was dispatched to respond Code 3 to assist Sr. Deputy Stephens. Additional units were also responding to the same location.

Shortly thereafter, Stephens stopped the vehicle in the parking lot of Mugu State Beach and ordered the suspect to exit her vehicle. Stephens advised dispatch that the suspect was not responding to his demands. As Stephens continued to communicate with Pearlman, she suddenly backed up and drove away through the parking lot with her lights off. Stephens returned to his patrol unit and advised dispatch he was in pursuit of the suspect. As the suspect approached the entrance/exit of the parking lot, Stephens slightly rammed the rear of the suspect's vehicle, causing it to drive toward the beach area, preventing her from entering Pacific Coast Highway.

Seconds later, Deputy Cerio arrived at the scene and reported Stephens's vehicle was stopped behind the suspect's vehicle in the parking lot facing north. Deputy Cerio parked along side and slightly back from Stephens' patrol car. When Cerio exited his unit, he activated his micro-cassette audio tape recorder. As Stephens attempted to communicate with Pearlman, she suddenly drove forward and slowly made an U-turn. Stephens attempted to stop her vehicle as she made the U-turn. Pearlman was able to drive around the front of Stephens' unit. Stephens stopped his vehicle and opened his driver's door. Stephens was sitting in the driver's seat. Cerio was standing outside and behind his opened driver's door. As Pearlman was passing the front of Stephens' unit, Cerio saw Pearlman stop her vehicle, lean forward and point a black handgun at Stephens.

While focusing on Pearlman, Cerio heard two gunshots. Cerio immediately saw pieces of broken glass flying away from Pearlman's front passenger side window.

After Cerio heard the first two gunshots, he noticed Pearlman driving toward his unit. Cerio backed away several feet from his unit; his driver's door remained opened. As Pearlman approached his unit, Cerio heard Stephens yell that he was going to shoot her tires. As she was passing Cerio's vehicle, Pearlman struck Cerio driver's door. At the same time, Cerio heard one more gunshot. As Pearlman continued to drive between Cerio and his unit, Cerio shot three rounds at R/F and R/R tires. Pearlman continued to drive toward PCH and eventually stopped near the chain-link fence along PCH. Both deputies approached the vehicle and discovered the victim was shot in the head.

Additional units and paramedics responded to the scene and secured the area. Investigators and crime lab personnel responded and processed the scene. The victim was eventually removed from the vehicle and transported to the Medical Examiner. The M.E. determined the cause of death was the result of a single gunshot wound to the head.

The Pearlman's family members reported she had a history of depressions and several suicidal attempts. Pearlman was initially believed to be a retired FBI agent, but a background check revealed she was employed by the FBI for two years as a clerk.

A crime scene investigation recovered seven 9mm shell casings. An inspection of the suspect's vehicle revealed the following:

- Two bullet holes in the driver's side window.
- Single bullet hole in the right front passenger's side window.
- Two bullet strikes in the L/R rim.
- One bullet hole in the R/R tire, which was flat.
- One bullet hole in the R/F tire, which was flat.
- One bullet strike in the R/F rim.

An inspection of the deputies' handguns revealed the following rounds were shot at the suspect and/or her vehicle.

Sr. Deputy Jason Stephens	Issued 9mm handgun	Four shots fired
Deputy Steve Cerio	Issued 9mm handgun	Three shots fired

A loaded 9mm semi-automatic handgun was found in her vehicle, located on the seat next to her left thigh. The handgun had a full magazine, with one round in the chamber and the safety off.

Upon his arrival at the scene, Deputy Cerio activated his micro-cassette tape recorder and recorded the shooting incident. In summary, the recording revealed Stephens' attempts to communicate with the suspect, Stephens yelling at the suspect to drop the gun, seven gunshots, and the deputies' communication with dispatch.

While at the scene, several citizen witnesses were contacted and interviewed. Deputy Cerio voluntarily did a walk-through interview with major crimes' investigators. Both deputies did not sustain any injuries. The Medical Examiner determined Pearlman died from a single gunshot to the head. All evidence was collected and booked into property.

Case was presented to DDA Bill Haney. The District Attorney ruled Senior Deputy Stephens acted reasonably and in self-defense under the circumstances. The D.A. concluded the shooting of Nancy Pearlman was a justifiable homicide.

CASE CLOSED

CRIME / INCIDENT REPORT

VENTURA COUNTY SHERIFF'S DEPARTMENT
AGENCY IDENTIFIER CA0560000

CONNECTING REPORT NUMBERS	2 R.D. 3262	3 BEAT 3C02	4 RB NUMBER 2003-8235
---------------------------	----------------	----------------	--------------------------

5 <input checked="" type="checkbox"/> CRIME <input type="checkbox"/> INCIDENT <input type="checkbox"/> SUPPLEMENTAL	<input type="checkbox"/> DOMESTIC <input type="checkbox"/> CHILD ABUSE <input type="checkbox"/> HATE
<input type="checkbox"/> CASE CLEARED	<input type="checkbox"/> GANG <input type="checkbox"/> ELDERLY ABUSE

7 CODE SECTION / DESCRIPTION (INCIDENT) PC417(C) - AT A PEACE OFFICER BRANDISHING FIREARM	8 CLASS. <input type="checkbox"/> Misd. <input checked="" type="checkbox"/> Fel.	9 CODE SECTION / DESCRIPTION (<input type="checkbox"/> Reclassify To)	10 CLASS. <input type="checkbox"/> Misd. <input type="checkbox"/> Fel.
-------------------------------------------------------------------------------------------------	----------------------------------------------------------------------------------------	------------------------------------------------------------------------	------------------------------------------------------------------------------

11 CODE SECTION / DESCRIPTION (INCIDENT)	12 CLASS. <input type="checkbox"/> Misd. <input type="checkbox"/> Fel.	13 CODE SECTION / DESCRIPTION (<input type="checkbox"/> Reclassify To)	14 CLASS. <input checked="" type="checkbox"/> Misd. <input type="checkbox"/> Fel.
------------------------------------------	------------------------------------------------------------------------------	-------------------------------------------------------------------------	-----------------------------------------------------------------------------------------

15 OCCURRED FROM MO. DAY YR. TIME 3 20 2003 1849	16 DOW THUR	17 OCCURRED TO MO. DAY YR. TIME 3 20 2003 1921	18 DOW THUR
--------------------------------------------------------	----------------	------------------------------------------------------	----------------

19 LOCATION OF OFFENSE / INCIDENT ADDRESS CITY STATE ZIP
MUGU STATE BEACH POINT MUGU CA.

20 CODE: V - VICTIM W - WITNESS R - REPORTING PARTY F - FINDER O - OWNER P - PARTY

21 CODE V-1	22 NAME (Last, First, Middle, Gen.) / FIRM NAME STEPHENS, JASON	AKA / Moniker	RACE 23	SEX 24	25 HT	26 WT	27 HAIR	28 EYES	29 DOB	30 AGE
----------------	--------------------------------------------------------------------	---------------	------------	-----------	-------	-------	---------	---------	--------	--------

31 RESIDENCE ADDRESS / (Same as Box #) CITY STATE ZIP 32 RESIDENCE PHONE () -

33 BUSINESS / SCHOOL NAME ADDRESS / (Same as Box #) CITY STATE ZIP 34 BUSINESS PHONE
V.C.S.D. 3701 E. LAS POSAS RD. CAMARILLO CA. (805)388-5100

35 OCCUPATION (<input type="checkbox"/> STUDENT) SENIOR DEPUTY	36 DAYS OFF VARIES	37 WORK HRS VARIES	38 INTERPRETER -	39 OPERATOR'S LIC. NO. / STATE -
--------------------------------------------------------------------	-----------------------	-----------------------	---------------------	-------------------------------------

40 VEH. LIC. NO. / STATE 41 VEH. COLOR / YEAR / MAKE / MODEL / BODY STYLE 42 OTHER CHARACTERISTICS / VIN NO.

43 CODE V-2	44 NAME (Last, First, Middle, Gen.) / FIRM NAME CERIO, STEVE	AKA / Moniker	RACE	SEX	47 HT	48 WT	49 HAIR	50 EYES	51 DOB	52 AGE
----------------	-----------------------------------------------------------------	---------------	------	-----	-------	-------	---------	---------	--------	--------

53 RESIDENCE ADDRESS / (Same as Box #) CITY STATE ZIP 54 RESIDENCE PHONE () -

55 BUSINESS / SCHOOL NAME ADDRESS / (Same as Box #) CITY STATE ZIP 56 BUSINESS PHONE
V.C.S.D. 800 S. VICTORIA AVE VENTURA CA. (805)654-2311

57 OCCUPATION (<input type="checkbox"/> STUDENT) DEPUTY	58 DAYS OFF VARIES	59 WORK HRS VARIES	60 INTERPRETER -	61 OPERATOR'S LIC. NO. / STATE -
-------------------------------------------------------------	-----------------------	-----------------------	---------------------	-------------------------------------

62 VEH. LIC. NO. / STATE 63 VEH. COLOR / YEAR / MAKE / MODEL / BODY STYLE 64 OTHER CHARACTERISTICS / VIN NO.

65 ARSON <input type="checkbox"/> Single Fam. Resd. <input type="checkbox"/> Inhabited <input type="checkbox"/> Uninhabited <input type="checkbox"/> Storage <input type="checkbox"/> Industrial <input type="checkbox"/> Commercial <input type="checkbox"/> Other Structure <input type="checkbox"/> Public Place <input type="checkbox"/> Vehicle <input type="checkbox"/> Unlawful Fire <input type="checkbox"/> Forest <input type="checkbox"/> Injury Occurred <input type="checkbox"/> Other	66 BURGLARY <input type="checkbox"/> Residential <input type="checkbox"/> Vehicle <input type="checkbox"/> Commercial <input type="checkbox"/> Other 67 ROBBERY <input checked="" type="checkbox"/> Bank <input type="checkbox"/> Chain Store <input type="checkbox"/> Commercial <input type="checkbox"/> Gas Station <input type="checkbox"/> Highway <input type="checkbox"/> Residence <input type="checkbox"/> Other	68 THEFT <input type="checkbox"/> Auto Parts <input type="checkbox"/> Bicycle <input type="checkbox"/> From Bldg. <input type="checkbox"/> Coin Machine <input type="checkbox"/> From Person <input type="checkbox"/> From Vehicle <input type="checkbox"/> Purse Snatch <input type="checkbox"/> Shoplift <input type="checkbox"/> Other 69 VALUE / DOLLAR LOSS \$ VALUE / DAMAGE LOSS \$	70 FORCE / WEAPON <input type="checkbox"/> No Force <input type="checkbox"/> No Weapon <input type="checkbox"/> Verbal Only <input type="checkbox"/> Attempt Only <input type="checkbox"/> Great Bodily Injury <input checked="" type="checkbox"/> Firearm <input type="checkbox"/> Knife <input type="checkbox"/> Hands/Fists/Feet <input type="checkbox"/> Other	71 DOMESTIC VIOLENCE / SEX / HATE CRIMES <input type="checkbox"/> D.V. and/or S. A. Pamphlet given to: <input type="checkbox"/> Victim <input type="checkbox"/> P-1 <input type="checkbox"/> P-2 <input type="checkbox"/> Pursuant to Sec. 6254 G.C., victim of D.V., Sex or Hate Crime requests their name be withheld from the public. <input type="checkbox"/> YES <input type="checkbox"/> NO	72 SPECIAL INTEREST (Copy to Agency/Unit) <input type="checkbox"/> Domestic Violence <input type="checkbox"/> Sex Crime <input type="checkbox"/> Child Abuse <input type="checkbox"/> PSSA <input type="checkbox"/> Gang Related <input type="checkbox"/> Hate Crime <input type="checkbox"/> Agricultural <input type="checkbox"/> Probation <input type="checkbox"/> Parole <input checked="" type="checkbox"/> Other MAJOR CRIMES
--------------------------------------------------------------------------------------------------------------------------------------------------------------------------------------------------------------------------------------------------------------------------------------------------------------------------------------------------------------------------------------------------------------------------------------------------------------------------------------------------------------------------------------------	-------------------------------------------------------------------------------------------------------------------------------------------------------------------------------------------------------------------------------------------------------------------------------------------------------------------------------------------------------------------------------------------------------------------------------------------------------------------	---------------------------------------------------------------------------------------------------------------------------------------------------------------------------------------------------------------------------------------------------------------------------------------------------------------------------------------------------------------------------------------------------------------------------------------	-----------------------------------------------------------------------------------------------------------------------------------------------------------------------------------------------------------------------------------------------------------------------------------------------------------------------------------------------------------------------------------------------	---------------------------------------------------------------------------------------------------------------------------------------------------------------------------------------------------------------------------------------------------------------------------------------------------------------------------------------------------------------------------------------------------------	--------------------------------------------------------------------------------------------------------------------------------------------------------------------------------------------------------------------------------------------------------------------------------------------------------------------------------------------------------------------------------------------------------------------------------------------------------------------

73 DATE AND TIME REPORTED 3/20/2003 1849	74 DATE / TIME OF REPORT 3/21/03 0330	75 REPORTING OFFICER / ID NO. / DIV. / UNIT MULROONEY/3283/WCP/CA	76 APPROVED BY / ID NO. S. Jorgensen/2486
---------------------------------------------	------------------------------------------	----------------------------------------------------------------------	----------------------------------------------

77 COPIES TO DET/MC NARC GANG/SED STATS PRESS DOJ COURT OTHER

ARREST / SUSPECT REPORT

VENTURA COUNTY SHERIFF'S DEPARTMENT
 AGENCY IDENTIFIER CA0560000

GANG HATE Page 1 of 2

1 CONNECTING REPORT NUMBERS		<input type="checkbox"/> ARREST ADULT <input type="checkbox"/> ARREST JUVENILE		2 RD	3 BEAT	4 RB NUMBER
5 CODE		<input checked="" type="checkbox"/> SUSPECT REPORT <input type="checkbox"/> STATUS OFFENDER		3262	3C02	2003-8235
6 NAME (Last, First, Middle, Gen.)			AKA / Moniker		7 BOOKING NUMBER	8 BI NUMBER
S PEARLMAN, NANCY JEAN						
9 RACE	10 SEX	11 HT	12 WT	13 BUILD	14 HAIR	15 EYES
16 DOB					17 AGE	18 POB (CITY/STATE)
						UNKNOWN
21 BUSINESS / SCHOOL NAME			ADDRESS (<input type="checkbox"/> Same as Box # _____)		CITY	STATE
RETIRED						
22 BUSINESS PHONE			27 OPERATOR'S LIC. / ID NO. STATE			
() -						
23 OCCUPATION (<input type="checkbox"/> STUDENT)		24 DAYS OFF	25 WORK HRS.	26 INTERPRETER		
28 VEH. LIC. NO. / STATE		29 VEH. COLOR	YEAR	MAKE	MODEL	30 DISPOSITION
						IMPOUNDED
31 DATE / TIME OF ARREST		32 LOCATION OF ARREST (<input type="checkbox"/> Same as Box # _____)			CITY	STATE
34 TYPE OF ARREST		35 LOCATION OF OFFENSE (<input type="checkbox"/> Same as Box # _____)			33 ARRESTING OFFICER / ID NO.	
<input type="checkbox"/> PC <input type="checkbox"/> WARRANT <input type="checkbox"/> PRIVATE PERSON		PIUGU STATE BEACH				
36 TRANSPORTING OFFICER / ID NO.						
37 CODE SECTION / DESCRIPTION	M	F	DOCKET NO.	DATE ISSUED	COURT	BAIL
38 PARENT / GUARDIAN NAME		ADDRESS (<input type="checkbox"/> Same as Box # _____)		STATE	ZIP	39 PHONE NO.
						()
42 EMERGENCY NOTIFICATION NAME (<input type="checkbox"/> Same as Box # _____)				ADDRESS	CITY	STATE
43 PHONE NO.				41 DATE / TIME		
()						
44 COMPLAINTS / EVIDENCE OF ILLNESS OR INJURY						
45 REQUEST FOR PROSECUTION						
I hereby arrest the above person on the charge(s) indicated above and request he/she be taken into custody. I request prosecution of the person I have arrested.				SIGNATURE:		
46 ARRESTING PERSON'S NAME (Print)		RESIDENCE ADDRESS		CITY	STATE	47 PHONE NO.
						()
48 IN VIEW OF THE INFORMATION HEREIN STATED, THE ABOVE ARRESTEE WAS NOT RELEASED PURSUANT TO 853.6 PC, SPECIFICALLY BECAUSE:						
<input type="checkbox"/> Arrested for misdemeanor violation of domestic violence protective court order.			<input type="checkbox"/> Immediate release would jeopardize prosecution.			
<input type="checkbox"/> Intoxicated state may result in danger to self or others.			<input type="checkbox"/> Reasonable likelihood that offense would continue by release of the person arrested.			
<input type="checkbox"/> Required medical examination or medical care or otherwise unable to care for own safety.			<input type="checkbox"/> Demanded immediate appearance before a magistrate or refused to sign notice to appear.			
<input type="checkbox"/> Arrested under one or more circumstances listed in Sections 40302 and 40303 CVC.			<input type="checkbox"/> Reason exists to believe person would not appear at time and place specified on notice.			
<input type="checkbox"/> There were one or more outstanding arrest warrants for the person.			<input type="checkbox"/> Other (see narrative).			
<input type="checkbox"/> Arrestee could not provide satisfactory evidence of personal identification.						
49 ARRESTEE STATUS: <input type="checkbox"/> IN CUSTODY / DETENTION <input type="checkbox"/> 849(b) PC <input type="checkbox"/> JUVENILE CITATION <input type="checkbox"/> MISD. CITATION						
RELEASED TO			CITATION NUMBER			
50 WHERE WAS ARRESTEE BOOKED?			51 DATE / TIME OF COURT APPEARANCE		52 COURT / DIVISION	
53 CASH		COIN	TOTAL	WITNESSED BY		DATE / TIME
55 ADMONISHED		ADMONISHED BY		55 WAIVED		WORDS USED TO WAIVE
<input type="checkbox"/> YES <input type="checkbox"/> NO				<input type="checkbox"/> YES <input type="checkbox"/> NO		
56 DATE / TIME						
57 DATE / TIME REPORTED		58 DATE / TIME OF REPORT		59 REPORTING OFFICER / ID NO. / DIV. / UNIT		60 APPROVED BY
3/20/03 1849		3/21/03 0400		MULROONEY/3283/WCPs/CAM		A. Argueta/2486
61 COPIES TO <input type="checkbox"/> DET/MC <input type="checkbox"/> NARC <input type="checkbox"/> GANG / SED <input type="checkbox"/> STATS <input type="checkbox"/> PRESS <input type="checkbox"/> DOJ <input type="checkbox"/> COURT <input type="checkbox"/> OTHER						

CRIME / INCIDENT REPORT

VENTURA COUNTY SHERIFF'S DEPARTMENT

AGENCY IDENTIFIER CA0560000

1 CONNECTING REPORT NUMBERS		2 R.D. 8101	3 BEAT 8A1	4 RB NUMBER 03-8235	
5 <input type="checkbox"/> CRIME <input checked="" type="checkbox"/> INCIDENT <input type="checkbox"/> SUPPLEMENTAL		6 <input type="checkbox"/> DOMESTIC <input type="checkbox"/> CHILD ABUSE <input type="checkbox"/> HATE <input type="checkbox"/> GANG <input type="checkbox"/> ELDERLY ABUSE			
7 CODE SECTION / DESCRIPTION (INCIDENT) SUICIDAL SUBJECT		8 CLASS. <input type="checkbox"/> Misd. <input type="checkbox"/> Fel.	9 CODE SECTION / DESCRIPTION (<input type="checkbox"/> Reclassify To)		
11 CODE SECTION / DESCRIPTION (INCIDENT)		12 CLASS. <input type="checkbox"/> Misd. <input type="checkbox"/> Fel.	13 CODE SECTION / DESCRIPTION (<input type="checkbox"/> Reclassify To)		
15 OCCURRED FROM MO. DAY YR. TIME 3 20 03 1851	16 DOW THUR	17 OCCURRED TO MO. DAY YR. TIME	18 DOW		
19 LOCATION OF OFFENSE / INCIDENT ADDRESS CITY STATE ZIP					
20 CODE V - VICTIM W - WITNESS R - REPORTING PARTY F - FINDER O - OWNER P - PARTY					
21 R	22 NAME (Last, First, Middle, Gen.) / FIRM NAME [REDACTED]	AKA / Moniker	RACE SEX	25 HT 26 WT 27 HAIR 28 EYES 29 DOB 30 AGE	
31 RESIDENCE ADDRESS / (<input checked="" type="checkbox"/> Same as Box # 19) CITY STATE ZIP			32 RESIDENCE PHONE		
33 BUSINESS / SCHOOL NAME ADDRESS / (<input type="checkbox"/> Same as Box # _____) CITY STATE ZIP DISABLED			34 BUSINESS PHONE ()		
35 OCCUPATION (<input type="checkbox"/> STUDENT)		36 DAYS OFF	37 WORK HRS	38 INTERPRETER	
40 VEH. LIC. NO. / STATE	41 VEH. COLOR / YEAR / MAKE / MODEL / BODY STYLE		42 OTHER CHARACTERISTICS / VIN NO.		
43 P1	44 NAME (Last, First, Middle, Gen.) / FIRM NAME [REDACTED]	AKA / Moniker	RACE SEX	47 HT 48 WT 49 HAIR 50 EYES 51 DOB 52 AGE	
53 RESIDENCE ADDRESS / (<input checked="" type="checkbox"/> Same as Box # 19) CITY STATE ZIP			54 RESIDENCE PHONE		
55 BUSINESS / SCHOOL NAME ADDRESS / (<input type="checkbox"/> Same as Box # _____) CITY STATE ZIP			56 BUSINESS PHONE ()		
57 OCCUPATION (<input type="checkbox"/> STUDENT)		58 DAYS OFF VARY	59 WORK HRS VARY	60 INTERPRETER NO	
62 VEH. LIC. NO. / STATE	63 VEH. COLOR / YEAR / MAKE / MODEL / BODY STYLE		64 OTHER CHARACTERISTICS / VIN NO.		
65 ARSON <input type="checkbox"/> Single Fam. Resd. <input type="checkbox"/> Inhabited <input type="checkbox"/> Uninhabited <input type="checkbox"/> Storage <input type="checkbox"/> Industrial <input type="checkbox"/> Commercial <input type="checkbox"/> Other Structure <input type="checkbox"/> Public Place <input type="checkbox"/> Vehicle <input type="checkbox"/> Unlawful Fire <input type="checkbox"/> Forest <input type="checkbox"/> Injury Occurred <input type="checkbox"/> Other		66 BURGLARY <input type="checkbox"/> Residential <input type="checkbox"/> Vehicle <input type="checkbox"/> Commercial <input type="checkbox"/> Other 67 ROBBERY <input type="checkbox"/> Bank <input type="checkbox"/> Chain Store <input type="checkbox"/> Commercial <input type="checkbox"/> Gas Station <input type="checkbox"/> Highway <input type="checkbox"/> Residence <input type="checkbox"/> Other		68 THEFT <input type="checkbox"/> Auto Parts <input type="checkbox"/> Bicycle <input type="checkbox"/> From Bldg. <input type="checkbox"/> Coin Machine <input type="checkbox"/> From Person <input type="checkbox"/> From Vehicle <input type="checkbox"/> Purse Snatch <input type="checkbox"/> Shoplift <input type="checkbox"/> Other 69 VALUE / DOLLAR LOSS \$ _____ 70 VALUE / DAMAGE LOSS \$ _____	
70 FORCE (WEAPON) <input type="checkbox"/> No Force <input type="checkbox"/> No Weapon <input type="checkbox"/> Verbal Only <input type="checkbox"/> Attempt Only <input type="checkbox"/> Great Bodily Injury <input checked="" type="checkbox"/> Firearm <input type="checkbox"/> Knife <input type="checkbox"/> Hands/Fists/Feet <input type="checkbox"/> Other		72 SPECIAL INTEREST <input type="checkbox"/> (Copy to Agency/Unit) <input type="checkbox"/> Domestic Violence <input type="checkbox"/> Sex Crime <input type="checkbox"/> Child Abuse <input type="checkbox"/> PSSA <input type="checkbox"/> Gang Related <input type="checkbox"/> Hate Crime <input type="checkbox"/> Agricultural <input type="checkbox"/> Probation <input type="checkbox"/> Parole <input checked="" type="checkbox"/> Other MAJOR CRIME			
73 DATE AND TIME REPORTED 3/20/03/1851		74 DATE / TIME OF REPORT 3/20/03/2345		75 REPORTING OFFICER / ID NO. / DIV. / UNIT JOHNSON 3267/wlp/cam	
76 APPROVED BY / ID NO. A. Jogh / 2486					
COPIES TO <input checked="" type="checkbox"/> DET / MC <input type="checkbox"/> NARC <input type="checkbox"/> GANG / SED <input type="checkbox"/> STATS <input type="checkbox"/> PRESS <input type="checkbox"/> DOJ <input type="checkbox"/> COURT <input type="checkbox"/> OTHER					

NARRATIVE REPORT VENTURA COUNTY SHERIFF'S DEPARTMENT

Page 1 of 3

Continuation

AGENCY IDENTIFIER CA0560000

1 R.D. 8101	2 BEAT 841	3 RB NUMBER 03-8235
----------------	---------------	------------------------

4 CODE	5 ITEM	6 QTY.	7 ITEM NAME	8 BRAND / MAKE MANUFACTURER	9 MODEL NAME OR NUMBER	10 MISC. DESCRIPTION	11 IDENTIFICATION / SERIAL NUMBER	12 VALUE
--------	--------	--------	-------------	-----------------------------	------------------------	----------------------	-----------------------------------	----------

On 3/20/03, I was working uniformed patrol in the City of Camarillo. At approximately 1851 hours, Deputies Hollowell, San [REDACTED], and I responded to [REDACTED] reference a suicidal female. Dispatch advised us that Nancy Pearlman, [REDACTED] left the residence in a [REDACTED] license plate [REDACTED]. She had a Smith and Wesson 9mm handgun with sixteen rounds of ammunition in her possession. Pearlman was last seen at the residence approximately one hour and thirty minutes prior to the call. Dispatch also advised us that Pearlman suffers from depression and takes Paxil, anti-depressants, and sleeping pills.

While enroute to [REDACTED] dispatch gave two updated broadcasts. The first broadcast said that Nancy was possibly enroute to the Mugu Rock area. The second broadcast said the [REDACTED] is equipped with the On-Star navigation system and the RP was attempting to obtain the exact whereabouts of the vehicle. When I arrived, I contacted [REDACTED]. I asked [REDACTED] if he was able to locate the vehicle. [REDACTED] said the On-Star system could only be activated from inside the vehicle. I also confirmed with [REDACTED] the information he gave to the dispatcher.

I asked [REDACTED] if Nancy left a suicide note. He said "no, but I want to show you something." [REDACTED] escorted me to the master bedroom, which is located at the northwest side of the house. We went inside the bedroom and he pointed to a gun pouch resting on the left side of the bed near the pillows. The gun pouch was unzipped with the beige interior exposed. The exterior of the gun pouch was [REDACTED] and appeared to be something similar to suede. There was also a black Verizon cellular telephone resting on the inside of the gun pouch. [REDACTED] said the cellular telephone belonged to Nancy. He also said his 9mm Smith and Wesson was gone. [REDACTED] said he had previously hid the gun from Nancy in a "Lucchese 2000" shoebox in the master bedroom closet.

I asked [REDACTED] if he had a recent photograph of Nancy. We left the master bedroom and I followed him out into the hallway adjacent to the master bedroom. [REDACTED] selected a photograph from the top of a storage shelf. He took the photograph out of the frame and gave it to me. [REDACTED] and I went into the kitchen area and we sat down at a table to discuss Nancy's behavior. As we began talking, I heard over my portable radio from the dispatcher that 3C51 had located the [REDACTED] near the Point Mugu "Rock." Shortly thereafter, I heard the dispatcher announce that the vehicle was not yielding. I also heard several other Sheriff's units including 3DK beginning to respond to the Point Mugu Rock area. I explained to [REDACTED] that the vehicle was located and several units were enroute to assist the deputy that found the [REDACTED]. I also told him that a K-9 unit was also enroute. [REDACTED] told me it was a good idea because Nancy would never hurt a dog. I called dispatch from [REDACTED] home phone and I told the call taker [REDACTED] that 3DK was a good option because Nancy was an animal lover and would never hurt the dog. I told [REDACTED] I would continue to monitor the radio for updated information.

During the conversation, [REDACTED] asked me several times if Nancy was in the [REDACTED]. I told him that I was not sure. Throughout our conversation, [REDACTED] would either receive phone calls or make phone calls to other family members. During one of his phone calls, I heard the dispatcher over the radio mention a "head wound." I also heard the dispatcher mention that fire and ambulance were enroute. After [REDACTED] hung up the phone, I called dispatch from [REDACTED] phone and I spoke with Captain Lemay. Captain Lemay confirmed that Nancy had a head wound. I asked Captain Lemay if I should

13 DATE / TIME OF REPORT 3/23/03 1900	14 REPORTING OFFICER / ID NO / DIV / UNIT JOHNSON 3267 / WCP / CAM	15 APPROVED BY / ID NO <i>A. [Signature]</i> / 2486
------------------------------------------	-----------------------------------------------------------------------	--------------------------------------------------------

NARRATIVE REPORT VENTURA COUNTY SHERIFF'S DEPARTMENT

Page 2 of 3

Continuation

AGENCY IDENTIFIER CA0560000

1 R.D. 8101	2 BEAT 8A1	3 RB NUMBER 03-8235
----------------	---------------	------------------------

4 CODE	5 ITEM	6 QTY.	7 ITEM NAME	8 BRAND / MAKE MANUFACTURER	9 MODEL NAME OR NUMBER	10 MISC. DESCRIPTION	11 IDENTIFICATION / SERIAL NUMBER	12 VALUE
--------	--------	--------	-------------	-----------------------------	------------------------	----------------------	-----------------------------------	----------

tell [redacted] about Nancy's condition. At this point, Captain Lemay told me not to tell [redacted] about Nancy's condition. I hung up the phone and I told [redacted] that there was a "standoff" between Nancy and the deputies.

I asked [redacted] several questions about Nancy and he told me the following: He and Nancy have been married for approximately 28 years. They separated approximately one month ago and were planning to divorce. After the separation, Nancy moved to Las Vegas. [redacted] said they do not have any biological kids together.

[redacted] said Nancy has a history of depression and traumatic brain injury. She has been prescribed Paxil and sleeping pills to help with her condition, however, he was unsure if Nancy had been taking the pills regularly. [redacted] said Nancy made two suicide attempts in the past. The first attempt was in 1974 and the other was in 1990. During the 1974 attempt, Nancy took 100 Valium pills and drank a bottle of wine. During the 1990 attempt, Nancy got into a bathtub with a hair dryer. After the 1990 attempt, she was hospitalized for 30 days in Las Vegas. [redacted] said since that time Nancy had verbally threatened suicide several times. [redacted] did not know the names of Nancy's doctors. He said she kept that part of her life private. [redacted] did say that Nancy was seen by a psychologist (unknown name) at Kaiser.

[redacted] said on 3/13/03, he traveled to Lon [redacted] and returned on 3/19/03. On 3/15/03, Nancy came to Camarillo from Las Vegas to settle some property issues and to visit some of her friends. Nancy stayed at the house [redacted] and slept in the master bedroom while he was gone. [redacted] said when he returned home from Lon [redacted], Nancy mentioned on several occasions that she wanted to reconcile their relationship. [redacted] told her he did not want to get back together because of his biological kids from a previous marriage and because of money.

[redacted] said at approximately 1715 hours (3/20/03), he told Nancy he was going to meet with his mother. [redacted] said earlier that day, he and Nancy had a discussion about their relationship. Nancy told [redacted] she would not file for divorce and that he would have to do it. [redacted] said as he was leaving, Nancy asked him for a hug and said, "I won't see you again." [redacted] said he left the house and when he returned, Nancy was gone. [redacted] said he went into the master bedroom and he saw the gun pouch lying open on the bed with the gun missing. [redacted] said he had no idea when he left the house, that Nancy would have found the gun and left with it.

After the conclusion of my interview, I called dispatch to speak with Captain Lemay. Deputy Lantz answered the phone and said there had been an officer involved shooting. I eventually spoke with Captain Lemay and he told me that per my Commander, I was to continue telling [redacted] that the situation with Nancy was still in a "standoff" until further notice.

I also spoke with [redacted] who was at the house. [redacted] said that she is the adopted daughter of [redacted] and Nancy. She has been living with them at [redacted] for two and a half years. [redacted] said that she is aware that Nancy takes sleeping pills for a medical condition.

13 DATE / TIME OF REPORT

3/23/03/1900

14 REPORTING OFFICER / ID NO / DIV / UNIT

JOHNSON 3267/wcp/cam

15 APPROVED BY / ID NO

[Signature] / 2486

NARRATIVE REPORT VENTURA COUNTY SHERIFF'S DEPARTMENT

Page 3 of 3

Continuation

AGENCY IDENTIFIER CA0560000

1 R.D. 8101	2 BEAT 891	3 RB NUMBER 03-8235
----------------	---------------	------------------------

4 CODE	5 ITEM	6 QTY.	7 ITEM NAME	8 BRAND / MAKE MANUFACTURER	9 MODEL NAME OR NUMBER	10 MISC. DESCRIPTION	11 IDENTIFICATION / SERIAL NUMBER	12 VALUE
--------	--------	--------	-------------	-----------------------------	------------------------	----------------------	-----------------------------------	----------

██████████ said that ██████████ went to Lon ██████████ on 3/13/03 and returned on 3/19/03. On 3/15/03, Nancy came back to Camarillo from ██████████ and stayed at the house ██████████ ██████████ said Nancy was feeling very good and was happy to be back home. She said there was no indication that Nancy might be suicidal. ██████████ also said that Nancy did not want to divorce ██████████ because "he was the meaning of her life."

Between 2130 and 2200 hours, A Ventura County Medical Examiner, a Sheriff's Chaplain, and Sergeant Powers from Sheriff's Major Crimes, arrived at the scene and made the death notification to ██████████

After the notification, I spoke with ██████████ biological son. ██████████ drove to Camarillo from his home in ██████████ after his father called him and told him about the incident. ██████████ said he has not seen Nancy in about three weeks. ██████████ told me he had a good relationship with Nancy, however, there were periods when they did not get along. ██████████ said he was aware that Nancy suffers from depression and takes medication to help with the condition. ██████████ told me he knows that ██████████ and Nancy are separated and are contemplating divorce. ██████████ recalled two previous separations between Nancy and ██████████. ██████████ also told me his brother, ██████████ saw Nancy earlier in the day. ██████████ said ██████████ told him that Nancy was upset and had been crying.

At approximately 2240 hours, Deputy Neibergall arrived at the residence and took photographs of the gun pouch and the cellular telephone. At approximately 2314 hours, Sergeant Powers relieved me of my duties at the scene.

13 DATE / TIME OF REPORT 3/23/03 / 1900	14 REPORTING OFFICER / ID NO / DIV / UNIT JOHNSON 3267 / WCP / CAM	15 APPROVED BY / ID NO <i>A. Aguilar</i> / 12486
--------------------------------------------	-----------------------------------------------------------------------	-----------------------------------------------------

NARRATIVE REPORT VENTURA COUNTY SHERIFF'S DEPARTMENT

Page 1 of 33 Continuation

AGENCY IDENTIFIER CA0560000

3201	30	03-8235
------	----	---------

4	5	6	7	8	9	10	11	12
DATE	ITEM	QTY.	ITEM NAME	BRAND / MAKE MANUFACTURER	MODEL NAME OR NUMBER	MISC. DESCRIPTION	IDENTIFICATION / SERIAL NUMBER	VALUE

Supplemental Case Cleared
 Gang Domestic Hate Child Abuse Elderly Abuse

Connecting Report Numbers:

Code Section / Description: **OFFICER INVOLVED SHOOTING**

Code: **SUSPECT** Name: **PEARLMAN, NANCY**

On 3-20-2003, at approximately 1930, I was contacted by my supervisor, Captain K. Fadler, concerning an officer involved shooting incident that just occurred at Point Mugu State Beach and instructed me to respond to the location. At approximately 2015, I arrived at the location. Upon my arrival, I attended a briefing with fellow investigators concerning the shooting. In summary, Commander D. Tennessen advised that Sr. Deputy Stephens and Deputy Cerio were involved in a shooting that occurred in the parking lot of Point Mugu State Park/Beach. The suspect, identified as Nancy Pearlman, was dead and was still sitting in the driver's seat of her vehicle. The parking lot was secured. Both patrol units and the suspect's vehicle were still in the parking lot and have not been moved. In addition, there were several citizen witnesses with their vehicles detained in the parking lot. Interviews of the witnesses were pending. Shortly after the briefing, assignments were given and the crime scene investigation began. The following is a summary of this investigation:

CASE SUMMARY

On 3-20-2003 [REDACTED] contacted the Ventura County Sheriff's Department and reported his wife, Suspect Nancy Pearlman, was suicidal and armed with a loaded 9mm semi-automatic handgun. Several deputies responded to the Pearlman's residence located at [REDACTED] and spoke with the [REDACTED]. The deputies completed an incident report—Case # 03-8235. In summary, the report stated the following:

[REDACTED] and Nancy Pearlman are married and currently separated. [REDACTED] and Nancy are anticipating filing for divorce. Nancy attempted to reconcile their relationship but [REDACTED] informed Nancy he wanted the divorce. [REDACTED] has been living in the house located in [REDACTED]. Nancy has

13 DATE TIME OF REPORT 04/29/03 10:14	14 REPORTING OFFICER ID # / UNIT E. Montagna #1047 / Sgt.	15 APPROVED BY / ID # <i>[Signature]</i>
------------------------------------------	--------------------------------------------------------------	---------------------------------------------

NARRATIVE REPORT VENTURA COUNTY SHERIFF'S DEPARTMENT

Page 2 of 33 Continuation

AGENCY IDENTIFIER CA0560000

1 PD 3281	2 BEAT 3C	3 REPORT NUMBER 03-8235
--------------	--------------	----------------------------

4 CODE	5 ITEM	6 QTY.	7 ITEM NAME	8 BRAND / MAKE MANUFACTURER	9 MODEL NAME OR NUMBER	10 MISC. DESCRIPTION	11 IDENTIFICATION / SERIAL NUMBER	12 VALUE
--------	--------	--------	-------------	-----------------------------	------------------------	----------------------	-----------------------------------	----------

been living in their other home in [REDACTED] reported Nancy has a history of depression and traumatic brain injury. Nancy is currently under a doctor care and is taking prescribed medications that include Paxil, antidepressants, and sleeping pills. [REDACTED] is unaware if Nancy has been regularly taking her medications. Nancy has attempted suicide in the past. In 1974, Nancy attempted suicide by ingesting 100 Valium pills by drinking a bottle of wine. Again, in 1990, Nancy attempted suicide by placing a hair dryer into a bathtub full of water. Soon after her attempt in 1990, Nancy was hospitalized in [REDACTED] for depression. Since then, Nancy has verbally threatened suicide several times.

[REDACTED] reported that Nancy was armed and suicidal. Nancy had discovered a handgun that [REDACTED] had hidden in a closet. The handgun was in a small gun pouch that was hidden inside a box. [REDACTED] showed the deputies the opened gun pouch that Nancy left on the bed. A cellular phone was resting on the inside of the open gun pouch. [REDACTED] confirmed the phone belonged to Nancy. [REDACTED] described the handgun as a loaded 9mm Semi-Automatic handgun. [REDACTED] stated the significance of the phone inside the gun pouch was Nancy's statement that she is contemplating suicide and, because the phone was left on the pouch, he would be unable to contact / stop her. [REDACTED] reported Nancy might be driving their [REDACTED] with [REDACTED]. In addition, [REDACTED] reported that Nancy frequents the beach area and might be enroute to the Mugu Rock area off of Pacific Coast Highway.

While the deputies were attempting to continue their interview with [REDACTED] Sr. Deputy Jason Stephens, serial number 2743, located the [REDACTED] at Point Mugu State Park. Point Mugu State Beach is located along Pacific Coast Highway (PCH) north of Mugu Rock. Sr. Deputy Stephens was working uniform patrol in a black/white patrol unit, assigned as unit number 3C51. Sr. Deputy Stephens informed dispatch that he saw the suspect in the vehicle and was attempting to stop her. At the same time, Deputy Cerio, serial number 3415, was instructed to respond Code 3 to assist Stephens. Deputy Cerio was working uniform patrol in a black/white patrol unit, assigned as unit number 3D51. In addition, several other units advised dispatch that they were also responding to assist Stephens. Via his radio, Sr. Deputy Stephens advised dispatch he had stopped the vehicle in the area of Point Mugu State Beach and was attempting to communicate with the suspect. As units

13 DATE TIME OF REPORT 04/29/03 10:14	14 REPORTING OFFICER (ID NO. OR UNIT) E. Montagna #1047 / Sgt.	15 APPROVED BY (ID NO.) <i>[Signature]</i> 2720
------------------------------------------	-------------------------------------------------------------------	----------------------------------------------------

NARRATIVE REPORT VENTURA COUNTY SHERIFF'S DEPARTMENT

Page ³ of 33 Continuation

AGENCY IDENTIFIER CA0560000

1 3261	2 BEAT 3C	3 REPORT NUMBER 03-8235
--------	-----------	-------------------------

4 CODE	5 ITEM	6 QTY.	7 ITEM NAME	8 BRAND / MAKE MANUFACTURER	9 MODEL NAME OR NUMBER	10 MISC. DESCRIPTION	11 IDENTIFICATION / SERIAL NUMBER	12 VALUE
--------	--------	--------	-------------	-----------------------------	------------------------	----------------------	-----------------------------------	----------

were responding to his location, Stephens informed dispatch via his radio the suspect was not complying with his demands. Several citizen witnesses in the parking lot saw Sr. Deputy Stephens standing outside his patrol unit attempting to communicate with the suspect. Shortly thereafter, the suspect backed up and began to drive away with her lights off. Stephens returned to his vehicle and advised dispatch he was in pursuit of the suspect. As the suspect approached the entrance/exit of the parking lot, Stephens slightly rammed the left rear corner of the suspect's vehicle. The suspect continued to travel north into the parking lot. At this time, Deputy Cerio drove into the parking lot and stopped next to Sr. Deputy Stephens.

Note: Witnesses referred to north as driving up PCH towards the Point Mugu Naval Air Base. In reality, PCH runs east west. This report will continue to refer to north as Point Mugu Naval Air Base. Refer to attached diagram for details.

Sr. Deputy Stephens' vehicle was facing northbound. Deputy Cerio stopped along side and slightly back from Stephen's vehicle. The suspect was stopped in front of Stephens' unit. Refer to attached diagram. Deputy Cerio opened his driver's door, stepped out of his unit, and stood behind his opened driver's door. Stephens attempted to communicate with the suspect, telling her that, "We are here to help you." Sr. Deputy Stephens instructed Deputy Cerio to turn on his tape recorder. Deputy Cerio activated his micro-cassette audio tape recorder. Shortly thereafter, the suspect then drove forward and began to make a U-turn. Stephens began to move and cut off the suspect. The suspect continued her U- turn and began to drive around the front of Stephen's unit in a southerly direction towards Deputy Cerio. As the suspect drove by the front of Stephens' vehicle, the suspect stopped. Deputy Cerio heard Sr. Deputy Stephens yell, "Put the gun down." At the same time, Deputy Cerio saw the suspect leaning forward and pointing a handgun at Sr. Deputy Stephens. Sr. Deputy Stephens shot two rounds into the suspect's driver's side door window. One round struck the suspect in the left side of her head. The other round traveled through the interior of her vehicle and exited out the front passenger' side door window. At the same time he heard the gunshots, Deputy Cerio saw pieces of broken glass flying away from the suspect's passenger side door window. Deputy Cerio immediately advised dispatch of "shots fired." Both deputies were unaware that the suspect was shot in the head.

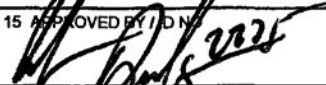
13 DATE TIME REPORT 04/25/03 10:14	14 REPORTING OFFICER / ID # / UNIT E. Montagna #1047 / Sgt.	15 APPROVED BY / ID # 
------------------------------------	-------------------------------------------------------------	-------------------------------------------------------------------------------------------------------------

NARRATIVE REPORT VENTURA COUNTY SHERIFF'S DEPARTMENT

Page 4 of 33 Continuation

AGENCY IDENTIFIER CA0560000

3281

30

03-8235

4	5	6	7	8	9	10	11	12
DE	ITEM	QTY.	ITEM NAME	BRAND / MAKE MANUFACTURER	MODEL NAME OR NUMBER	MISC. DESCRIPTION	IDENTIFICATION / SERIAL NUMBER	VALUE

The suspect continued to drive toward Deputy Cerio. As the suspect approached his unit, Deputy Cerio backed away from his car towards the beach. Sr. Deputy Stephens got out of his unit and ran after the suspect. As he approached Cerio's unit, Stephens shot two rounds at the suspect's L/R (left-rear) tire, hitting the L/R rim twice. The suspect continued to approach Deputy Cerio's car. As she drove by Deputy Cerio's unit, the suspect struck Cerio's opened driver's door. As the suspect continued to travel between Deputy Cerio and his unit, Cerio shot at the suspect's tires. Deputy Cerio shot three rounds. One round entered and exited the right rear tire. The other two rounds struck the front right tire and rim. One round entered and exited the R/F tire. The other round struck the R/F rim. The suspect continued to travel southeast and eventually came to rest on a berm adjacent to a chain-link fence along PCH. Both tires on the right side of the suspect's vehicle were flat.

Stephens and Cerio immediately approached the suspect's vehicle on foot. Cerio approached the front passenger door. Cerio noticed that the front passenger side window was "spidered." Because the doors were locked, Cerio smashed the front passenger's side door window in an attempt to open the doors. Cerio unlocked the doors and opened the front passenger's door. Cerio saw the suspect sitting in the driver's seat. Cerio ran around the car to the driver's door. With the driver's door opened, Cerio saw a black semi-automatic handgun on the edge of the seat next to the suspect's left thigh. Cerio immediately picked up the gun. Cerio saw the suspect had a head wound. Believing the suspect was not a threat; Cerio put the gun down in the same position on the seat where he found it. Both deputies backed away from the car and requested fire/paramedics respond to the scene.

Shortly thereafter, Sr. Deputy Heersche arrived on scene and maintained security of the scene until additional units responded. Several paramedics arrived at the scene and briefly examined the suspect. Paramedics pronounced the suspect dead and left the scene. An ICS was established. Investigators and crime scene investigators arrived and conducted an investigation. The scene was processed and evidence was collected. Medical Examiner personnel arrived at the scene and eventually transported the suspect to the M.E. for an autopsy. The following day, an autopsy was performed and the Medical Examiner determined the cause of death to be the result of a single gunshot wound to the head.

13 DATE TIME OF REPORT 04/25/03 10:14

14 REPORTING OFFICER / ID # / DIV / UNIT E. Montagna #10477 Sgt.

15 APPROVED BY ID #

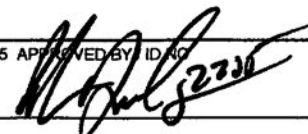

NARRATIVE REPORT VENTURA COUNTY SHERIFF'S DEPARTMENT

Page 5 of 33 Continuation

AGENCY IDENTIFIER CA0560000

1 201	2 BEAT 3C	3 REPORT NUMBER 03-8235
-------	-----------	-------------------------

4 CODE	5 ITEM	6 QTY.	7 ITEM NAME	8 BRAND / MAKE MANUFACTURER	9 MODEL NAME OR NUMBER	10 MISC. DESCRIPTION	11 IDENTIFICATION / SERIAL NUMBER	12 VALUE
--------	--------	--------	-------------	-----------------------------	------------------------	----------------------	-----------------------------------	----------

COMMUNICATION

On 3-20-2003, 18:49 hours, Ventura County Sheriff's Department dispatch center received a 911 call from [REDACTED]. Dispatcher U. [REDACTED] spoke with the R/P and entered the information into the dispatch communication system. All 911 calls are tape-recorded. The following is a summary of [REDACTED] telephone call to 911:

[REDACTED] stated, "I think my wife (Nancy Pearlman) has taken a gun and she is very suicidal right now. [REDACTED] had just returned home and discovered the gun case (pouch) on the bed with her cellular phone [REDACTED] provided a description of his wife and her vehicle, described as a [REDACTED] [REDACTED] informed [REDACTED] that he and his wife are going through a divorce and indicated Nancy has been "very despondent all day" and is currently taking prescription drugs that include Paxil (an antidepressant) and Ambien (a sleeping pill). [REDACTED] described the handgun as a "Smith & Wesson 9mm" with a "full clip" with approximately "fourteen rounds." When asked by [REDACTED] if Nancy would possibly shoot herself, [REDACTED] replied, "Yes." After receiving the 911 call, dispatcher Andrea [REDACTED] broadcast the aforementioned information to patrol. The following is a summary of the tape-recorded dispatch broadcast to patrol:

Andrea [REDACTED] instructed Unit # 8J51 (Brent Johnson #3267) and an additional "unit to assist" to respond to a suicidal subject call at the Pearlman's residence located at [REDACTED], Camarillo. Andrea informed the patrol units that Nancy Pearlman was suicidal, armed with a "Smith & Wesson 9mm with sixteen rounds," and driving a [REDACTED] with California license plate [REDACTED]. Andrea continued to say that Nancy was last seen at her residence approximately 1-½ hours ago. 8B11 (William Hollowell #3612) responded to assist 8J51.

Dispatch broadcasted the above information to all local units including CHP and LASO. Shortly thereafter, dispatch advised local units via the radio, that the R/P reported the subject (Nancy Pearlman) was possibly enroute to Mugu Rock. Sr. Deputy Stephens, assigned as 3C51, advised dispatch he was responding to the Mugu Rock area to search for the vehicle. [REDACTED] also advised the suspect's vehicle is equipped with an "on-star" system but later advised he was unable to have it activated.

13 DATE TIME OF REPORT 04/29/03 10:14

14 REPORTING OFFICER / ID # / DIV / UNIT E. Montagna #1047 / 7N1

15 APPROVED BY / ID NO [Signature]

NARRATIVE REPORT VENTURA COUNTY SHERIFF'S DEPARTMENT

Page 6 of 33 Continuation

AGENCY IDENTIFIER CA0560000

3261	30	03-8235
------	----	---------

4	5	6	7	8	9	10	11	12
DE	ITEM	QTY.	ITEM NAME	BRAND / MAKE MANUFACTURER	MODEL NAME OR NUMBER	MISC. DESCRIPTION	IDENTIFICATION / SERIAL NUMBER	VALUE

At 1915 hours, Sr. Deputy Stephens advised dispatch he located the vehicle approximately 1/4 mile past Mugu Rock. Shortly thereafter, Sr. Deputy Stephens informed dispatch "the vehicle is starting to move away. I am in pursuit." At approximately 1918 hours, Deputy Cerio (3D51) arrived on scene. When Deputy Cerio arrived on scene, he informed dispatch via his radio that he was "10-97." While listening to the dispatch's audio tape recording, I could hear Sr. Deputy Stephens in the background talking to the suspect as Deputy Cerio was attempting to communicate with dispatch. I heard Stephens say, "Let me get you some help." Deputy Cerio continued to inform dispatch that the subject was "not complying" with their demands. During this time, additional units were responding to the location. Deputy Cerio continued to inform dispatch that Nancy was "still not complying" and was still "in the vehicle." At approximately 1921 hours, Deputy Cerio informed dispatch, "Shots fired." Shortly thereafter, additional personnel, including fire and paramedics, arrived at the scene. Refer to 'Calls for Service Summary' document for details.

SCENE DESCRIPTION

The shooting incident occurred in the parking lot of Point Mugu State Beach, located between Mugu Rock and the Point Mugu Naval Air Base. The parking lot is located on the ocean side of Pacific Coast Highway (PCH). The parking lot is enclosed by a chain-link fence that is located along the ocean side of PCH. There is a single entrance / exit into the parking lot. The parking lot is primarily hard dirt, gravel and asphalt. Refer to Sr. Deputy Popp's diagram for details. There are no lights within the parking lot. There are also no streetlights along this section of PCH.

Citizen witnesses indicated that, although the sun had set, the parking was not completely dark at the time of the shooting. The weather was cool and dry.

The suspect's vehicle, a four-door [REDACTED] was stopped next to a small embankment inside the parking lot located adjacent to the chain link fence facing south. The vehicle's engine was

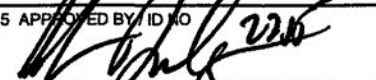
13 DATE TIME REPORT 04/25/83 10:14	14 REPORTING OFFICER ID # / PRINT E. Montagna #1047 / Sgt.	15 APPROVED BY / ID NO 
---------------------------------------	---------------------------------------------------------------	-----------------------------------------------------------------------------------------------------------------

NARRATIVE REPORT VENTURA COUNTY SHERIFF'S DEPARTMENT

Page 7 of 33 Continuation

AGENCY IDENTIFIER CA0560000

3261	3C	03-8235
------	----	---------

4 DE	5 ITEM	6 QTY.	7 ITEM NAME	8 BRAND / MAKE MANUFACTURER	9 MODEL NAME OR NUMBER	10 MISC. DESCRIPTION	11 IDENTIFICATION / SERIAL NUMBER	12 VALUE
------	--------	--------	-------------	-----------------------------	------------------------	----------------------	-----------------------------------	----------

running and its headlights were on. The driver's and front passenger's doors were opened. Both tires on the right side were flat. There was minor damage to the left rear corner of the vehicle. The front driver's side window had what appeared to have two gunshot holes. The window was shattered but intact. The front passenger's side window was shattered with a large hole. On the front passenger floorboard were pieces of broken glass and a pair of blue latex gloves that were left by one of the two paramedics. The suspect, a white female, was sitting in the driver's seat with the seat belt fastened across the front of her. The suspect had an obvious gunshot wound to the left side of her head next to her left eye. There was blood on the suspect's face, body, and seat. On the seat and next to her left thigh was a black semi-automatic handgun. The handgun was pointed towards the front of the vehicle and lying on its top with the handle pointing upward. The handgun was discovered to be loaded, with a chambered round, a full magazine, and the safety off. Both patrol units were parked northwest of the suspect's vehicle, north of the entrance/exit of the parking lot. Refer to diagram for details.

OFFICERS' STATEMENT

Sr. Deputy Jason Stephens' Statement

Immediately after the shooting incident, the scene was secured and an ICS was established. Major Crimes and crime scene investigation personnel were notified and responded to the scene. One of the investigators that responded to the scene was Sgt. W. Ayub, serial number 3318. Sgt. Ayub reported, upon his arrival at the scene, he briefly spoke with Sr. Deputy Stephens and conducted a public safety interview. The interview was not recorded. Sgt. Ayub completed a report depicting his interview with Stephens. In summary, Ayub reported the following information:

Sr. Deputy Stephens was working uniform patrol assigned to unit 3C51 and driving vehicle #3338. Sr. Deputy Stephens informed Sgt. Ayub that he was facing northwest as the suspect drove around the front of his vehicle. As the vehicle drove around the front of his vehicle, he fired two shots

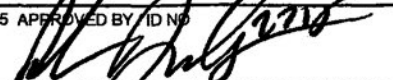
13 DATE TIME OF REPORT 04/25/03 10:14	14 REPORTING OFFICER ID NO / UNIT E. Montagna #1047 / Sgt.	15 APPROVED BY / ID NO 
------------------------------------------	---------------------------------------------------------------	-----------------------------------------------------------------------------------------------------------------

NARRATIVE REPORT VENTURA COUNTY SHERIFF'S DEPARTMENT

Page 8 of 33 Continuation

AGENCY IDENTIFIER CA0560000

1 P.D. 3261	2 BEAT 3C	3 R.D. NUMBER 03-8235
----------------	--------------	--------------------------

4 CODE	5 ITEM	6 QTY.	7 ITEM NAME	8 BRAND / MAKE MANUFACTURER	9 MODEL NAME OR NUMBER	10 MISC. DESCRIPTION	11 IDENTIFICATION / SERIAL NUMBER	12 VALUE
--------	--------	--------	-------------	-----------------------------	------------------------	----------------------	-----------------------------------	----------

from his service pistol at the vehicle's driver's side door window. Stephens said he was partially seated in his patrol car when he shot at the vehicle. As the vehicle continued to pass his unit, Stephens thought the driver was going to flee the scene. Stephens stated he yelled at Deputy Cerio that he was going to "blow the tires." Stephens said he fired one to two rounds at the suspect vehicle's left rear tire. Stephens reported he shot towards the ground in the direction of the beach. At the same time, he heard Deputy Cerio shoot one to two rounds. Sr. Deputy Stephens indicated the suspect had a handgun. After the incident, Sr. Deputy Stephens remained in a vehicle with fellow officer, Sergeant Miller, until representatives from LDF arrived. Major Crimes' investigators conducted no further interviews with Sr. Deputy Stephens.

Later that morning, Ken Yuwiler, LDF attorney representing Sr. Deputy Stephens, contacted me outside the command center and requested that he and Sr. Deputy Stephens conduct a walk through interview with Sheriff's Personnel / I.A. investigators. Yuwiler was aware that the crime scene investigators were still processing the scene. Yuwiler indicated that he was willing to conduct the walk through as long as anyone not involved in the walk through interview did not listen to the interview. Shortly thereafter, Yuwiler, Sr. Deputy Stephens and sheriff's Personnel / IA investigators conducted the walk through interview. Crime scene investigators continued their investigation and did not interfere with them. Approximately forty-five minutes later, Yuwiler informed me that the interview was completed. Crime scene investigators continued their investigation.

13 DATE / TIME OF REPORT 04/29/03 10:14	14 REPORTING OFFICER / ID NO. / DIV / UNIT E. Montagna #1047 / Sgt.	15 APPROVED BY / ID NO. 
--------------------------------------------	------------------------------------------------------------------------	------------------------------------------------------------------------------------------------------------------

NARRATIVE REPORT VENTURA COUNTY SHERIFF'S DEPARTMENT

Page 9 of 33 Continuation

AGENCY IDENTIFIER CA0560000

1 PD 3261	2 BEAT 3C	3 REPORT NUMBER 05-8235
--------------	--------------	----------------------------

4 DE	5 ITEM	6 QTY.	7 ITEM NAME	8 BRAND / MAKE MANUFACTURER	9 MODEL NAME OR NUMBER	10 MISC. DESCRIPTION	11 IDENTIFICATION / SERIAL NUMBER	12 VALUE
------	--------	--------	-------------	-----------------------------	------------------------	----------------------	-----------------------------------	----------

Deputy Steve Cerio's Statement

Sgt. Powers, serial number 1356, assigned to the Major Crimes' investigation team, also responded to the shooting incident. Upon his arrival at the scene, Powers conducted a public safety interview with Deputy Cerio. The interview was not tape-recorded. In summary, Powers reported that Cerio showed him where his patrol unit was parked and the general direction the shots were fired. Cerio stated he shot 2 to 3 rounds at the suspect's vehicle tires in the direction of PCH.

Shortly after the shooting, Sr. Deputy Stephens and Deputy Cerio were placed into a vehicle with fellow officer, Sgt. Miller. Later that evening, the following representatives from the Ventura County Deputy Sheriffs' Association and LDF arrived on scene:

- Rick Shimmel Ventura County Deputy Sheriffs' Association
- Ken Yuwiler Legal Defense Fund (LDF) attorney

At approximately 0100 A.M., Mr. Yuwiler told me Deputy Cerio was willing to conduct a walk-through interview with Major Crimes' investigators. Mr. Yuwiler and Deputy Cerio agreed to the walk-through and allowed the following personnel to accompany them during the walk-through. Also, Mr. Yuwiler and Deputy Cerio agreed that the interview could be both audio and video-recorded. The following personnel were present during the walk-through:

Sgt. Ernie Montagna	Investigator	VCSD Major Crimes (audio-tape)
Inv. Dave Stone	Investigator	D.A. Office
John West	DDA	D.A. Office
FET Ian [REDACTED]	CSI	VCSD Crime Lab (video tape operator)
Ken Yuwiler	Attorney	LDF Attorney
Rick Shimmel	Attorney	VCDSA Representative
Sgt. E. Dowd	Investigator	VCSD Personnel / I.A.
Detective [REDACTED] Rivera	Investigator	VCSD Major Crimes (audio tape)
Alan Wisotsky	Attorney	County Attorney

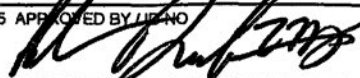
13 DATE TIME OF REPORT 04/25/03 7:10:14	14 REPORTING OFFICER / ID NO. / DIV / UNIT E. Montagna #10477 Sgt.	15 APPROVED BY / ID NO. 
--------------------------------------------	-----------------------------------------------------------------------	------------------------------------------------------------------------------------------------------------------

NARRATIVE REPORT VENTURA COUNTY SHERIFF'S DEPARTMENT

Page 10 of 33 Continuation

AGENCY IDENTIFIER CA0560000

1 P.D. # 3261	2 BEAT # 3C	3 REPORT NUMBER 03-8235
------------------	----------------	----------------------------

4 DE	5 ITEM	6 QTY.	7 ITEM NAME	8 BRAND / MAKE MANUFACTURER	9 MODEL NAME OR NUMBER	10 MISC. DESCRIPTION	11 IDENTIFICATION / SERIAL NUMBER	12 VALUE
------	--------	--------	-------------	-----------------------------	------------------------	----------------------	-----------------------------------	----------

During the interview, FET [REDACTED] videotaped Deputy Cerio's interview. Detective Rivera and I also recorded the interview on our audio tape recorders. The following is a summary of Deputy Cerio's tape-recorded interview:

Prior to entering the scene, the above personnel introduced themselves on tape. Upon completion of the introduction, Deputy Cerio briefly stated the following information prior to entering the parking lot:

Deputy Cerio was working uniform patrol in a VCSO black/white patrol unit, vehicle # 3415. Deputy Cerio was assigned as unit 3D51. Earlier this evening, while driving in the Oxnard area, Cerio overheard via his radio that unit 3C51 (Sr. Deputy Stephens) received a call of a possible suicidal subject. Deputy Cerio decided to drive toward 3C51 location in case Stephens needed assistance. Deputy Cerio contacted Sr. Deputy Stephens via his radio on Channel 4. Deputy Cerio advised Stephens he was enroute to assist him and requested his exact location. Stephens replied that his current location was Las Posas Road and PCH. Cerio advised Stephens his present location was Rice Road and 5th Street, Oxnard. Deputy Cerio returned his radio to Channel 1 and advised dispatch he was enroute to assist Stephens.

While driving to Stephens' location, Cerio heard via his radio that Stephens was 10-6 (Busy) in South Coast. South Coast is the area along PCH between Point Mugu Naval Air Base and Malibu. Due to the mountain ranges that are located along PCH, radio transmissions are poor and many times, impossible to transmit or receive messages, thus deputies inform dispatch when they enter this area.

Cerio drove westbound on Rice Road, through the detour (construction site along Highway One), to PCH. Cerio continued southbound on PCH towards Mugu State Beach. Upon arriving at the Mugu State Beach parking lot, Cerio saw Stephens' vehicle stopped in the parking lot facing north with its emergency lights on. The suspect's vehicle was stopped approximately fifteen feet in front of Stephens' patrol unit.

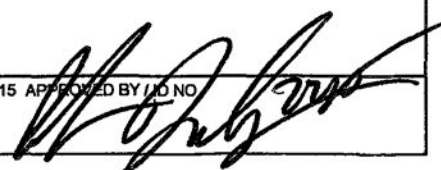
13 DATE TIME OF REPORT 04/25/03 10:14	14 REPORTING OFFICER / ID NO. / DIV / UNIT E. Montagna #10477 Sgt.	15 APPROVED BY / ID NO. 
------------------------------------------	-----------------------------------------------------------------------	------------------------------------------------------------------------------------------------------------------

NARRATIVE REPORT VENTURA COUNTY SHERIFF'S DEPARTMENT

Page 11 of 33 Continuation

AGENCY IDENTIFIER CA0560000

1 PD 3201	2 BEAT 30	3 RB NUMBER 03-8235
--------------	--------------	------------------------

4 DE	5 ITEM	6 QTY.	7 ITEM NAME	8 BRAND / MAKE MANUFACTURER	9 MODEL NAME OR NUMBER	10 MISC. DESCRIPTION	11 IDENTIFICATION / SERIAL NUMBER	12 VALUE
------	--------	--------	-------------	-----------------------------	------------------------	----------------------	-----------------------------------	----------

After Cerio's above statement, we entered the parking lot through the entrance and walked toward Cerio's patrol unit. While standing near the left rear corner of his unit, Cerio continued to state the following:

As soon as he heard that Stephens had located the suspect, Cerio responded Code 3. Cerio entered the parking lot and stopped his vehicle along side and slightly backed from Stephens' vehicle, approximately ten to fifteen feet away. Since entering the parking lot and stopping his vehicle at its present position, Cerio stated his vehicle has not been moved. I noticed Cerio's car motor was running. The overhead red/blue lights were on along with his headlights and driver's spotlight. Cerio's driver's door was opened. Stephens' unit also had its overhead red/blue lights on along with his headlights and driver's spotlight. Stephens' vehicle is facing in a northwest direction with its lights directed toward the beach in a slightly westerly direction. Stephens' drivers' door was closed and the engine was on. Refer to photographs/diagram for details.

Note: Witnesses refer to Point Mugu Naval Air Base as north. In reality, the air station is west of the parking lot. The reports will continue to refer to north in the direction of Point Mugu Naval Air Base.

As soon as Cerio entered the parking lot and stopped his vehicle, Cerio reported the following:

- Stephens' vehicle was approximately ten to fifteen away and to the right of Cerio's car pointing in a northerly direction.
- Stephens' vehicle was stopped with its driver's door opened.
- Stephens was out of his vehicle, "standing at the V of his (driver's) door" and "with the subject at gunpoint."
- The suspect's vehicle was "approximately ten to fifteen in front of Stephens' car also pointing in a northerly direction. Cerio indicated that all of the vehicles were pointed towards the red light, referring to a red light located north of the parking lot on a mountainside in the direction of Point Mugu Naval Air Base. The red light appears to originate from a radio/tower station located along the mountainside.
- Cerio pointed his driver's spotlight at the suspect's vehicle.

13 DATE TIME OF REPORT 04/25/03 7:10:14	14 REPORTING OFFICER / ID NO / DIV / UNIT E. Montagna #10477 Sgt.	15 APPROVED BY / ID NO 
--------------------------------------------	----------------------------------------------------------------------	-----------------------------------------------------------------------------------------------------------------

NARRATIVE REPORT VENTURA COUNTY SHERIFF'S DEPARTMENT

Page 12 of 33 Continuation

AGENCY IDENTIFIER CA0560000

1 PD 3261	2 BEAT 3C	3 RB NUMBER 03-8235
--------------	--------------	------------------------

4 CODE	5 ITEM	6 QTY.	7 ITEM NAME	8 BRAND / MAKE MANUFACTURER	9 MODEL NAME OR NUMBER	10 MISC. DESCRIPTION	11 IDENTIFICATION / SERIAL NUMBER	12 VALUE
--------	--------	--------	-------------	-----------------------------	------------------------	----------------------	-----------------------------------	----------

Upon stopping his vehicle, Cerio opened his driver's door, exited his vehicle, removed his handgun from his holster and stood behind the "V" of his driver's door. While standing outside his vehicle behind the driver's door, Cerio saw the suspect in the driver's seat of her vehicle. Cerio stated he saw "her head moving." Cerio saw only one subject in the vehicle. Stephens' vehicle lights were pointed at the suspect's vehicle. Because Stephens' vehicle lights and Cerio's vehicle lights, including his spotlight, were directed at the suspect's vehicle, Cerio said he could see the suspect in her car.

While standing behind his driver's door, Cerio could hear Stephens yelling at the suspect. As Stephens yelled at the suspect, Cerio could see the suspect "moving...side to side" in the driver's seat. The suspect was not responding to Stephens' demands to exit her vehicle. At this time, Stephens asked Cerio if he had a tape recorder. Cerio replied that he did have a tape recorder. Stephens instructed Cerio to turn his recorder on. Cerio removed his micro-cassette audio tape recorder from his pouch located on his Sam [REDACTED] belt, turned on the recorder and placed it on the roof of his patrol unit.

Stephens continued to talk to the suspect. Cerio could hear Stephens tell the suspect to roll down her window, telling her, "We are here to help." During this time, as Stephens was attempting to talk to her, Cerio contacted dispatch approximately three times, advising dispatch that the suspect was not complying with their demands.

Shortly thereafter, Cerio saw the suspect "crack her (driver's) window." Stephens continued to talk to the suspect. Cerio could not recall what Stephens said to the suspect. Then Cerio told me that he heard the suspect "mumbles stuff back." Cerio said the suspect's statements were "inaudible to me. I [REDACTED]t know if Jason (Stephens) could hear it or not." Cerio thought he heard Stephens instruct the suspect to roll down her window a little more so that he could hear her. Then Cerio saw the suspect "put her car in drive" and begin to move north "toward the red light." Cerio could not recall if the suspect's vehicle lights were on.

As soon as she moved forward, the suspect slowly started to make a U-turn toward the beach. Stephens jumped into his unit and began to follow the suspect in a northwest direction, like he was "cut (ting) the pie." Cerio indicated the two vehicles were very close. At this time, Cerio got

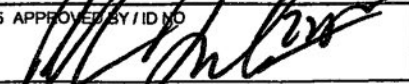
13 DATE / TIME OF REPORT 04/25/03 7:10:14	14 REPORTING OFFICER / ID NO. / DIV / UNIT E. Montagna #10477 Sgt.	15 APPROVED BY / ID NO. 
----------------------------------------------	-----------------------------------------------------------------------	------------------------------------------------------------------------------------------------------------------

NARRATIVE REPORT VENTURA COUNTY SHERIFF'S DEPARTMENT

Page 13 of 33 Continuation

AGENCY IDENTIFIER CA0560000

3261	36	3 REV NUMBER 056235
------	----	------------------------

4 CODE	5 ITEM	6 QTY.	7 ITEM NAME	8 BRAND / MAKE MANUFACTURER	9 MODEL NAME OR NUMBER	10 MISC. DESCRIPTION	11 IDENTIFICATION / SERIAL NUMBER	12 VALUE
--------	--------	--------	-------------	-----------------------------	------------------------	----------------------	-----------------------------------	----------

into his vehicle. As soon as he got into his car, Cerio remembered he left his recorder on the roof of his car. Cerio got out of his vehicle again, grabbed the recorder, threw the recorder onto the front seat, and returned to the driver's seat. As soon as he got into his vehicle the second time, Cerio saw the suspect's vehicle facing his (Cerio) car. Stephens's vehicle was slightly back from its current position. Cerio's vehicle remained in its same position. Cerio was now concentrating on the suspect's vehicle. Cerio saw the suspect continue to pass the front of Stephens' car. As the suspect drove by the front of Stephens' vehicle, the suspect suddenly stopped. The suspect's vehicle's left rear side door was next to Stephens' left front corner of his car.

Once the suspect's stopped her vehicle, Cerio told me he saw "some interaction between her and Stephens." Cerio was still sitting in his driver's seat of his vehicle. Cerio could "not hear anything." At the same time, while focusing on the suspect, Cerio saw "a black gun come up." Cerio said the gun was "pointed right at Stephens." Cerio stated the suspect's driver's side window was up. The suspect was leaning forward and pointing a handgun at Stephens. Cerio could not recall what hand the suspect used to hold the gun. As the suspect pointed the gun at Stephens, Cerio could see the suspect's mouth moving but could not hear what she was saying.

As soon as Cerio saw the handgun, Cerio heard two gunshots. Since he was focusing on the suspect, Cerio could not recall where Stephens was located. As he heard the gunshots, Cerio saw pieces of glass fragments come out of the suspect vehicle's passenger side. At the same time, Cerio jumped out of his vehicle. Cerio saw the suspect's vehicle continue to drive toward him. Cerio saw the suspect's vehicle "begin to pick up speed." Once out of his car, with his handgun in his hand, Cerio began to "back peddle" (move backwards) toward the No Parking sign, located southwest from his location. Refer to diagram for details. Cerio's driver's door remained opened. As Cerio continued to step backwards, he shined his flashlight at the suspect. Cerio stated, "I could see her in the vehicle, but I [REDACTED] see a threat. So I keep back peddling (moving backwards)." Cerio saw the suspect's vehicle "clip" his opened driver's door and continue to move forward. Cerio felt the suspect was going to exit the parking lot and drive away onto PCH. Cerio decided to shoot at the suspect's tires. Cerio told me he believed he shot "twice", shooting at the

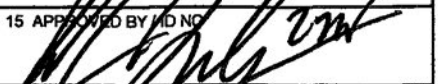
13 DATE TIME OF REPORT 04/25/03 10:14	14 REPORTING OFFICER ID # / PRINT E. Montagna #1047 / Sgt.	15 APPROVED BY (ID NO) 
------------------------------------------	---------------------------------------------------------------	-----------------------------------------------------------------------------------------------------------------

NARRATIVE REPORT VENTURA COUNTY SHERIFF'S DEPARTMENT

Page 14 of 33 Continuation

AGENCY IDENTIFIER CA0560000

3261	3C	03-8235
------	----	---------

4	5	6	7	8	9	10	11	12
DE	ITEM	QTY.	ITEM NAME	BRAND / MAKE MANUFACTURER	MODEL NAME OR NUMBER	MISC. DESCRIPTION	IDENTIFICATION / SERIAL NUMBER	VALUE

right front and the right rear tires. The suspect's vehicle continued to travel between Cerio and his patrol car towards PCH.

Just prior to shooting the tires, Cerio stated he heard Stephens yell that he was going to shoot out her tires. Cerio said he heard one shot. As the suspect passed him, he noticed "spider glass" on the suspect's front passenger side door window. The vehicle continued to travel towards PCH and came to rest at its current position. Both Stephens and Cerio ran after the vehicle. Once the vehicle came to rest, Cerio believed that Stephens approached the driver's side. At the same time, Cerio approached the passenger side.

Upon arriving at the passenger side, Cerio checked the front passenger door and realized the door was locked. Using his flashlight, Cerio smashed the window, shined his light into the interior of the vehicle and pointed his handgun at the suspect. Cerio noticed the suspect was not moving. Cerio unlocked the door and opened the front passenger door. After he opened the passenger door, Cerio ran around the vehicle and approached the driver's door. Upon arriving at the driver's door, Cerio saw the suspect's handgun on the edge of the seat next to her left thigh. Cerio immediately grabbed the gun.

After grabbing the gun, Cerio noticed the suspect had a head wound. Realizing that the suspect had a head wound and was not a threat; Cerio put the handgun on the seat in the same position where he had found it.

Cerio returned to his car, retrieved his first aid kit and returned to the suspect to administer first aid. Realizing the suspect had a head wound, Cerio requested that paramedics via his radio to respond to their location. Shortly thereafter, responding units and paramedics arrived on scene. The interview was concluded at 0120 A.M.

On 4-16-03, 1600, met with Deputy Cerio and LDF attorney Yuwiler at the West County Patrol station. While at the station, I briefly spoke with Cerio concerning his initial stop in the parking lot. Cerio said, when he arrived in the parking lot, he parked his vehicle along the driver's side of Stephens' vehicle, approximately ten to fifteen away and slightly back. The suspect's vehicle was stopped approximately ten to fifteen feet in front of Stephens' patrol car. Referring to the attached diagram, the suspect moved slightly forward and began to make a U-turn towards the beach.

13 DATE TIME OF REPORT 04/25/03 10:14	14 REPORTING OFFICER / ID NO. / UNIT E. Montagna #1047 / Sgt.	15 APPROVED BY / ID NO. 
------------------------------------------	------------------------------------------------------------------	------------------------------------------------------------------------------------------------------------------

NARRATIVE REPORT VENTURA COUNTY SHERIFF'S DEPARTMENT

Page 15 of 33 Continuation

AGENCY IDENTIFIER CA0560000

1. P.D. 3261	2. BEAT 3C	3. REPORT NUMBER 05-8235
-----------------	---------------	-----------------------------

4. CODE	5. ITEM	6. QTY.	7. ITEM NAME	8. BRAND / MAKE MANUFACTURER	9. MODEL NAME OR NUMBER	10. MISC. DESCRIPTION	11. IDENTIFICATION / SERIAL NUMBER	12. VALUE
---------	---------	---------	--------------	------------------------------	-------------------------	-----------------------	------------------------------------	-----------

Stephens immediately turned to the left in an attempt to cut off the suspect. The suspect was able to make the U-turn and drive in front of Stephens' unit. As the suspect drove by the front of Stephens' vehicle, the suspect stopped and pointed a handgun at Sr. Deputy Stephens. Cerio's vehicle remained in the same position throughout the incident.

13 DATE TIME OF REPORT
04/25/03 7:10:14

14 REPORTING OFFICER / ID NO. / DIV / UNIT
E. Montagna #10477 Sgt.

15 APPROVED BY / ID NO.

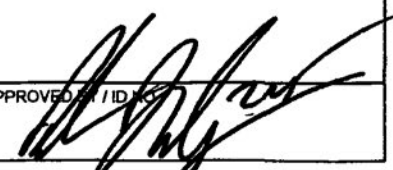

NARRATIVE REPORT VENTURA COUNTY SHERIFF'S DEPARTMENT

Page 16 of 33 Continuation

AGENCY IDENTIFIER CA0560000

1 PD 3261	2 BEAT 3C	3 RD NUMBER 03-8235
--------------	--------------	------------------------

4 CODE	5 ITEM	6 QTY.	7 ITEM NAME	8 BRAND / MAKE MANUFACTURER	9 MODEL NAME OR NUMBER	10 MISC. DESCRIPTION	11 IDENTIFICATION / SERIAL NUMBER	12 VALUE
--------	--------	--------	-------------	-----------------------------	------------------------	----------------------	-----------------------------------	----------

WITNESSES' STATEMENTS

Shortly after the shooting, responding officers began to arrive at the scene. While attempting to secure the scene, officers located several citizen witnesses that were in the parking lot at the time of the shooting. All of the witnesses were located on the southwest end of the parking lot. The witnesses were either standing outside or sitting in their parked vehicles. The following statements are a summary of tape-recorded interviews that fellow officers conducted. The witnesses stated the following:

INTERVIEW

[REDACTED]

The following interview was conducted and recorded by Sgt. W. Ayub. [REDACTED] stated the following:

[REDACTED] and his girlfriend [REDACTED] were sitting in his parked vehicle, which was located approximately 300 feet southwest of the entrance. [REDACTED] and [REDACTED] were eating their food and talking to each other. Approximately five minutes after they arrived in the parking lot, [REDACTED] saw a police car shine its lights on a parked [REDACTED]. The [REDACTED] was facing the ocean and parked about fifty feet south of their vehicle. [REDACTED] saw the deputy exited his vehicle and heard him yell at the occupant of the [REDACTED] to get out of the car several times. [REDACTED] was sitting in the driver's seat with his driver's side window down. [REDACTED] looked at the [REDACTED] and saw a lone female sitting in the driver's seat moving her head from side to side.

While the deputy was standing just outside of his patrol car holding his gun down to his side, [REDACTED] saw the [REDACTED] back up and drive toward the entrance/exit of the parking lot with its lights off. The deputy got into his car, turned his lights on and followed the [REDACTED]

13 DATE TIME OF REPORT
04/25/05 10:14

14 REPORTING OFFICER I.D. NO. DIV. UNIT
E. Montagna #10477 Sgt.

15 APPROVED BY I.D. NO.

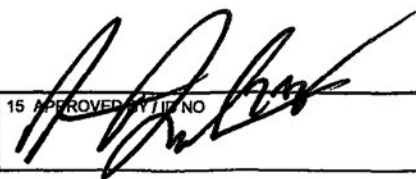

NARRATIVE REPORT VENTURA COUNTY SHERIFF'S DEPARTMENT

Page 17 of 33 Continuation

AGENCY IDENTIFIER CA0560000

1 P.O. NUMBER 3261	2 BEAT 3C	3 REPORT NUMBER 03-8235
-----------------------	--------------	----------------------------

4 CODE	5 ITEM	6 QTY.	7 ITEM NAME	8 BRAND / MAKE MANUFACTURER	9 MODEL NAME OR NUMBER	10 MISC. DESCRIPTION	11 IDENTIFICATION / SERIAL NUMBER	12 VALUE
--------	--------	--------	-------------	-----------------------------	------------------------	----------------------	-----------------------------------	----------

As the [redacted] drove away, [redacted] saw the [redacted] driving erratically, speeding up and slowing down. As the [redacted] and police car approached the entrance/exit of the parking lot, [redacted] saw the police car ram the [redacted] left rear quarter panel. Shortly after ramming the [redacted], both the police car and the [redacted] came to a stop. At the same time, a second police car arrived in the parking lot and parked behind the other police unit. [redacted] saw both deputies outside of their cars; he could not tell what they were doing or what they were saying. [redacted] indicated that both police cars had their emergency lights flashing.

[redacted] briefly turned his attention away from the police vehicles. When he looked again, [redacted] saw the [redacted] had made a U-turn and drive past the police units. As the [redacted] passed the second police car, he heard five shots—two shots followed by three more shots. The [redacted] continued to drive and stop at its current position. [redacted] stated the [redacted] came very close to the second police unit as it passed it. [redacted] estimated he was approximately 125 feet away from the patrol cars. Due to the distance and the darkness, he was unable to see details of the shooting.

INTERVIEW

[redacted]

On 3-20-03, Detective Rivera interviewed witness [redacted] at the scene. Detective Rivera reported the following:

[redacted] and her boyfriend, [redacted] arrived at the parking lot earlier that evening and parked their vehicle at the southeast end of the lot. Upon their arrival, [redacted] saw the suspect's vehicle parked near the east end of the parking lot. Shortly after arriving at the beach, [redacted] saw a police car stop near the suspect's vehicle with its emergency lights and spot light on. The deputy stepped out of his car and held his handgun in his hand along his side. [redacted] heard the deputy say something at the suspect. Then the suspect's vehicle backed up without its

13 DATE/TIME OF REPORT
04/25/03 10:14

14 REPORTING OFFICER / ID NO. / DIV / UNIT
E. Montagna #10477 Sgt.

15 APPROVED BY / ID NO.

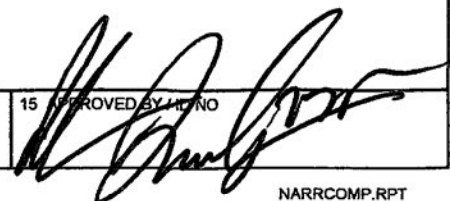

NARRATIVE REPORT VENTURA COUNTY SHERIFF'S DEPARTMENT

Page 18 of 33 Continuation

AGENCY IDENTIFIER CA0560000

1 P.D. # 3261	2 BEAT 3C	3 REPORT NUMBER 03-8235
------------------	--------------	----------------------------

4 DATE	5 ITEM	6 QTY.	7 ITEM NAME	8 BRAND / MAKE MANUFACTURER	9 MODEL NAME OR NUMBER	10 MISC. DESCRIPTION	11 IDENTIFICATION / SERIAL NUMBER	12 VALUE
--------	--------	--------	-------------	-----------------------------	------------------------	----------------------	-----------------------------------	----------

lights on and began to drive north toward the exit. As the suspect approached the exit, a police car had collided with the suspect's vehicle. Shortly afterwards, [REDACTED] heard "many" gunshots. [REDACTED] did not see the shooting incident. Moments later, she saw the suspect's vehicle travel toward the fence and stop.

INTERVIEW

[REDACTED]

While at the scene, Sgt. M. Smith, serial number 2622, reported she interviewed [REDACTED] stated the following:

[REDACTED] arrived at the Point Mugu State Beach with her boyfriend, [REDACTED]. They entered the parking lot and parked on the east side of the lot. While sitting outside of their vehicle, [REDACTED] saw a police unit enter the parking lot with its emergency lights on. Shortly thereafter, [REDACTED] and [REDACTED] began to walk to one of the portable restrooms located near the lifeguard towers on the beach. As they approached the restrooms, [REDACTED] saw two police cars stop behind a [REDACTED] facing in a northwest direction. [REDACTED] reported the SUV was pushing against one of the patrol units. Then [REDACTED] heard two gunshots follow by another set of three gunshots within approximately five seconds.

During this time, [REDACTED] reported she heard the officers' voices but could not tell what they said. And in between the first and second set of gunshots, she heard some yelling. As soon as she and [REDACTED] heard the gunshots, they took cover behind some bushes. Shortly thereafter, [REDACTED] heard the sounds of sirens and the arrival of additional police cars.

13 DATE TIME OF REPORT 04/29/03 10:14	14 REPORTING OFFICER I.D. NO. / UNIT E. Montagna #1047 / Sgt.	15 APPROVED BY I.D. NO. 
------------------------------------------	------------------------------------------------------------------	------------------------------------------------------------------------------------------------------------------

NARRATIVE REPORT VENTURA COUNTY SHERIFF'S DEPARTMENT

Page 19 of 33 Continuation

AGENCY IDENTIFIER CA0560000

3261

3C

03-8235

4	5	6	7	8	9	10	11	12
DE	ITEM	QTY.	ITEM NAME	BRAND / MAKE MANUFACTURER	MODEL NAME OR NUMBER	MISC. DESCRIPTION	IDENTIFICATION / SERIAL NUMBER	VALUE

INTERVIEW

[REDACTED]

On 3-20-2003, Detective Rivera interviewed witness [REDACTED] at the scene. In summary, Detective Rivera reported the following:

Earlier that evening, [REDACTED] and his girlfriend [REDACTED] arrived at the parking lot. Upon their arrival at the parking lot, [REDACTED] did not see the suspect's vehicle in the parking lot. [REDACTED] indicated the sun had just gone down by the time they arrived at the beach. [REDACTED] parked his vehicle.

Shortly afterwards, [REDACTED] saw a police car stop behind the suspect's vehicle with its emergency lights on. [REDACTED] heard the deputy tell the driver to stop. During this time [REDACTED] and his girlfriend began to walk to the restrooms located near the lifeguard towers. While enroute to the restrooms, [REDACTED] heard gunshots. [REDACTED] dove into some nearby bushes and remained there for several minutes. Soon afterwards, additional units arrived on scene.

INTERVIEW

[REDACTED]

On 3-20-2003, while at the scene, Detective Rivera interviewed [REDACTED] concerning the shooting incident. In summary, Detective Rivera reported the following:

[REDACTED] was sitting in her parked van located at the extreme southeast end of the parking lot facing the ocean. Shortly after arriving in the parking lot, she saw a police car enter the parking lot and stop behind the suspect's vehicle. Then [REDACTED] saw the suspect's vehicle leave and the police car following it. Shortly thereafter, [REDACTED] heard several gunshots but assumed it might be the military practicing at the firing range. (Between Mugu State Beach and the Point Mugu Naval

13 DATE TIME REPORT 04/25/03 10:14

14 REPORTING OFFICER (ID #) (U) (M) (T) E. Montagna #1047 Sgt.

15 APPROVED BY (U) NO

[Signature]

NARRATIVE REPORT VENTURA COUNTY SHERIFF'S DEPARTMENT

Page 20 of 33 Continuation

AGENCY IDENTIFIER CA0560000

2 PD 3261	3 BEAT 3C	3 REPORT NUMBER 03-8235
--------------	--------------	----------------------------

4 DATE	5 ITEM	6 QTY.	7 ITEM NAME	8 BRAND / MAKE MANUFACTURER	9 MODEL NAME OR NUMBER	10 MISC. DESCRIPTION	11 IDENTIFICATION / SERIAL NUMBER	12 VALUE
--------	--------	--------	-------------	-----------------------------	------------------------	----------------------	-----------------------------------	----------

Air Base is a military firing range located on the ocean side of PCH). During that time, [REDACTED] was not paying attention and did not see the events surrounding the shooting. At the time she heard the shots [REDACTED] said it was "not really dark." [REDACTED] reported the sun had set, yet she was able to see without any problems.

INTERVIEW

[REDACTED]

On 3-20-03, while at the scene, Detective Rivera interviewed citizen witness [REDACTED] Rivera reported the following:

[REDACTED] arrived at the parking lot approximately five minutes prior to the arrival of the first police unit entering the parking lot. [REDACTED] noticed the suspect's vehicle was possibly parked at the very southwest end of the parking lot facing the ocean. The officer shined his lights on the suspect's vehicle and got out of his car. The police vehicle had its emergency lights on. Once outside his unit, [REDACTED] heard the officer yell something at the occupant of the vehicle. Then [REDACTED] saw the suspect's vehicle back up and drive north through the parking lot with its lights off. The officer returned to his car and pursued the suspect. As the officer chased the suspect, [REDACTED] heard the siren of a police car. [REDACTED] remained in his car and did not hear any shots nor did he see the shooting incident.

INTERVIEW

Sr. Deputy Heersche #1312

On 3-20-2003, while working uniform patrol / crime suppression unit, Sr. Deputy Heersche responded to assist Sr. Deputy Stephens with a possible suicidal subject in the area of Mugu Rock. Sr. Deputy Heersche was assigned to a two-man car, with Deputy McConville as his

13 DATE TIME OF REPORT 04/25/03 10:14	14 REPORTING OFFICER I.D. NO. / DIV. / UNIT E. Montagna #1047 / Sgt.	15 APPROVED BY I.D. NO. 
------------------------------------------	-------------------------------------------------------------------------	------------------------------------------------------------------------------------------------------------------

NARRATIVE REPORT VENTURA COUNTY SHERIFF'S DEPARTMENT

Page 21 of 33 Continuation

AGENCY IDENTIFIER CA0560000

1 3281	2 BEAT 30	3 REPORT NUMBER 03-8235
--------	-----------	-------------------------

4 CODE	5 ITEM	6 QTY.	7 ITEM NAME	8 BRAND / MAKE MANUFACTURER	9 MODEL NAME OR NUMBER	10 MISC. DESCRIPTION	11 IDENTIFICATION / SERIAL NUMBER	12 VALUE
--------	--------	--------	-------------	-----------------------------	------------------------	----------------------	-----------------------------------	----------

partner. While enroute to the location, Sr. Deputy Heerche heard, via his police radio, that Sr. Deputy Stephens was in pursuit of the suspect. Sr. Deputy Heerche immediately responded Code 3 to assist. As they approached the South Coast area, Heerche heard again via his police radio that shots have been fired.

When they arrived at the parking lot, Heerche reported he saw the suspect's vehicle was stopped on an embankment just south of the entrance to the parking lot. Heerche and McConville drove into the parking lot and stopped directly behind the suspect's vehicle. Heerche saw Sr. Deputy Stephens next to the suspect's opened front passenger door and Deputy Cerio standing at the opened driver's door. Heerche saw Stephens approached him and McConville and told them, "She is 10-7." Heerche asked Stephens if her injury was self-inflicted. Stephens replied, 'I shot her.' Heerche advised dispatch of the circumstances and secured the scene.

In the meantime, several firemen/paramedics arrived on scene, attended to the suspect and pronounced the suspect dead. Heerche and McConville maintained inner perimeter security until approximately 2300 hours.

INTERVIEW

Fireman Fred [REDACTED]

Point Mugu Federal Fire Station

On 4-17-03, I spoke with fireman [REDACTED] who is employed at the Point Mugu Federal Fire Agency located at Point Mugu Naval Air Base. On 3-20-03, he and fellow firemen responded to a shooting that occurred at the Point Mugu State Beach. The following is a summary of a tape-recorded telephone interview I had with [REDACTED]

Upon arriving at the scene, [REDACTED] and fellow fireman [REDACTED] were instructed to check the suspect who was sitting in her vehicle [REDACTED] approached the vehicle. [REDACTED] saw a handgun on the left side of the suspect on the seat. [REDACTED] approached the driver's side of the

13 DATE TIME OF REPORT 04/25/03 10:14

14 REPORTING OFFICER / ID # / DIV / UNIT E. Montagna #1047 / Sgt.

15 APPROVED BY LIS NO



NARRATIVE REPORT VENTURA COUNTY SHERIFF'S DEPARTMENT

Page 22 of 33 Continuation

AGENCY IDENTIFIER CA0560000

1 PD 3261 2 BEAT 3C 3 REPORT NUMBER 03-8235

4 CODE	5 ITEM	6 QTY.	7 ITEM NAME	8 BRAND / MAKE MANUFACTURER	9 MODEL NAME OR NUMBER	10 MISC. DESCRIPTION	11 IDENTIFICATION / SERIAL NUMBER	12 VALUE
--------	--------	--------	-------------	-----------------------------	------------------------	----------------------	-----------------------------------	----------

vehicle and instructed [REDACTED] to check the suspect from the passenger's side because of the amount of blood on the suspect. [REDACTED] went to the passenger's side and checked the suspect. While wearing blue latex gloves, [REDACTED] checked the suspect for a pulse. [REDACTED] said he did not detect a pulse and pronounced the suspect dead. [REDACTED] removed his gloves and left them on the front passenger's floorboard. Shortly thereafter, [REDACTED] left the scene.

INTERVIEW

Fireman [REDACTED]

Point Mugu Federal Fire Station

On 4-17-03, I spoke with Fireman [REDACTED] who is employed with the Point Mugu Federal Fire Agency based at the Point Mugu Naval Air Base. On 3-20-2003, he and fellow firemen responded to a shooting scene located at Point Mugu State Beach. The following is a summary of a tape-recorded telephone interview I had with [REDACTED]

Upon arriving at the scene, [REDACTED] and fellow fireman [REDACTED] entered the parking lot. [REDACTED] briefly spoke with a deputy and was instructed to examine the suspect who was sitting in her vehicle. As [REDACTED] approached the vehicle, he noticed both the driver's and front passenger's doors were opened. [REDACTED] walked to the driver's side of the vehicle. [REDACTED] saw the passenger's side window was shattered and vehicle's engine was on. [REDACTED] reported the female suspect was sitting in the driver's seat. [REDACTED] saw a handgun on her left side next to her hip. [REDACTED] noticed she was shot in the head. [REDACTED] saw blood and some head matter on the female's body. [REDACTED] instructed [REDACTED] to approach the suspect from the passenger side to check her pulse. [REDACTED] went to the passenger side of the vehicle, checked the suspect's pulse and pronounced her dead. [REDACTED] informed a deputy on the scene that the suspect was dead. Shortly thereafter, [REDACTED] returned to their station.

13 DATE TIME OF REPORT 04/29/03 7:10:14

14 REPORTING OFFICER / ID NO. / UNIT E. Montagna #10477 / Sgt.

15 APPROVED BY / ID NO. 

NARRATIVE REPORT VENTURA COUNTY SHERIFF'S DEPARTMENT

Page 23 of 33 Continuation

AGENCY IDENTIFIER CA0560000

1 PD 3261	2 BEAT 3C	3 REPORT NUMBER 03-8235
--------------	--------------	----------------------------

4 DATE	5 ITEM	6 QTY.	7 ITEM NAME	8 BRAND / MAKE MANUFACTURER	9 MODEL NAME OR NUMBER	10 MISC. DESCRIPTION	11 IDENTIFICATION / SERIAL NUMBER	12 VALUE
--------	--------	--------	-------------	-----------------------------	------------------------	----------------------	-----------------------------------	----------

INTERVIEW



On 3-26-03, Sergeant Mike Powers, #1365, spoke with [REDACTED] by telephone concerning this investigation. In summary, Powers reported the following information:

[REDACTED] reported he and his wife have been close friends with [REDACTED] and Nancy Pearlman for the past fifteen years. [REDACTED] is aware of [REDACTED] and Nancy's "tumultuous" relationship and their pending divorce. Within the past several weeks, [REDACTED] has been assisting Nancy with her contacts with a divorce attorney [REDACTED] described Nancy as a very weak person in that "she could never make a decision at all." He indicated that [REDACTED] emotionally "beats her down" all the time. [REDACTED] was aware that Nancy was seeing a psychiatrist. [REDACTED] and Nancy have separated on prior occasions but have reconciled each time.

[REDACTED] reported on 3-3-03, Nancy told him that she was in possession of a gun and had hidden it from [REDACTED]. Nancy refused to tell [REDACTED] where she hid the gun. Several days later, [REDACTED] informed [REDACTED] that Nancy was in possession of a gun [REDACTED] replied that he thought Nancy might do "something bad with the gun." When [REDACTED] discovered that Nancy was killed, he told Powers, "I [REDACTED]'t think Nancy had the ability to kill herself. I think she had tried to commit suicide once before, but all I thought of was suicide by cop."

13 DATE TIME OF REPORT
04/29/03 10:14

14 REPORTING OFFICER I.D. NO. DIVISION
E. Montagna #10477 Sgt.

15 APPROVED BY [REDACTED]

NARRATIVE REPORT VENTURA COUNTY SHERIFF'S DEPARTMENT

Page 24 of 33 Continuation

AGENCY IDENTIFIER CA0560000

3201	3C	03-6235
------	----	---------

4	5	6	7	8	9	10	11	12
DE	ITEM	QTY.	ITEM NAME	BRAND / MAKE MANUFACTURER	MODEL NAME OR NUMBER	MISC. DESCRIPTION	IDENTIFICATION / SERIAL NUMBER	VALUE

PERSONNEL DATA

Senior Deputy Jason Stephens
 Serial Number 2743
 Assignment: Patrol Division

Deputy Steve Cerio
 Serial Number 3415
 Assignment: Patrol Division

SUSPECT DATA

Nancy Jean Pearlman
 Aka: Nancy Jean Smith

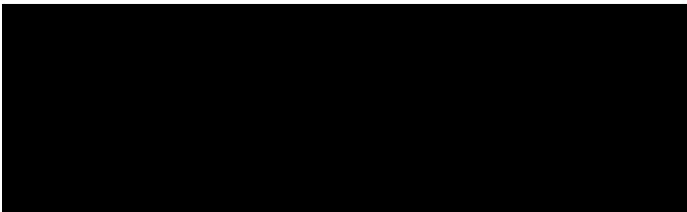

CII—None
 FBI—None

A California Department of Justice record check revealed the following handgun registered to **Nancy J. Pearlman** with a DOT (date of transaction) as of 7-12-1982:

-

A California Department of Justice record check revealed the following firearms registered to the husband of Nancy J. Pearlman:

13 DATE TIME OF REPORT 04/25/03 7:10:14	14 REPORTING OFFICER / ID # / DIV / UNIT E. Montagna #10477 Sgt.	15 APPROVED BY / ID NO
--------------------------------------------	---------------------------------------------------------------------	----------------------------

NARRATIVE REPORT VENTURA COUNTY SHERIFF'S DEPARTMENT

Page 26 of 33 Continuation

AGENCY IDENTIFIER CA0560000

2 PD 3261	3 BEAT 3C	3 RR NUMBER 03-8235
--------------	--------------	------------------------

4 DE	5 ITEM	6 QTY.	7 ITEM NAME	8 BRAND / MAKE MANUFACTURER	9 MODEL NAME OR NUMBER	10 MISC. DESCRIPTION	11 IDENTIFICATION / SERIAL NUMBER	12 VALUE
------	--------	--------	-------------	-----------------------------	------------------------	----------------------	-----------------------------------	----------

██████████ knew that Nancy has been in contact with an attorney, Marge Wilson—Thousand Oaks, concerning her divorce. Nancy was instructed to seek out an auditor to examine ██████████ assets because Nancy believed that many of the assets were possibly hidden.

██████████ said that Nancy had been admitted to a mental institution in Nevada and that he and fellow family members have seen her lose as much as thirty pounds in just a few months. During her last stay in ██████████ prior to her leaving for Camarillo, Nancy had told her sister she could have her jewelry.

WEAPONS

The following weapons were collected and booked into evidence in the following condition:

Senior Deputy Jason Stephens:

Issued Duty Weapon: ██████████
 Loaded with one magazine containing 10 rounds and one in the chamber. Note: Stephens reported he carries 14 rounds in the magazine with one round chambered.
 Two full magazines retrieved from Stephens' Sam ██████████—magazine pouch. Each magazine contained 15 rounds.
 Ammunition: Issued—Speer 9mm
 Collected from the person, Sr. Deputy Jason Stephens

Deputy Cerio:

Issued Duty Weapon: ██████████
 Loaded with one magazine containing 12 rounds with one in the chamber.
 Two full magazines retrieved from Cerio's Sam ██████████—magazine pouch. Each magazine contained 15 rounds.
 Ammunition: Issued—Speer 9mm
 Collected from the person, Deputy Cerio.

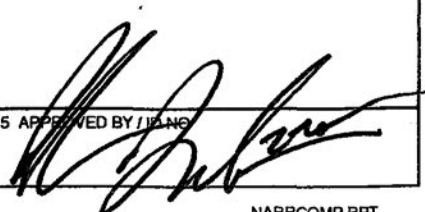
13 DATE / TIME OF REPORT 04/25/03 7:10:14	14 REPORTING OFFICER / ID NO. / DIV / UNIT E. Montagna #1047 / Sgt.	15 APPROVED BY / ID NO. 
----------------------------------------------	------------------------------------------------------------------------	------------------------------------------------------------------------------------------------------------------

NARRATIVE REPORT VENTURA COUNTY SHERIFF'S DEPARTMENT

Page 27 of 33 Continuation

AGENCY IDENTIFIER CA0560000

1 PD 3261	2 BEAT 3C	3 RB NUMBER 03-8235
--------------	--------------	------------------------

4 CODE	5 ITEM	6 QTY.	7 ITEM NAME	8 BRAND / MAKE MANUFACTURER	9 MODEL NAME OR NUMBER	10 MISC. DESCRIPTION	11 IDENTIFICATION / SERIAL NUMBER	12 VALUE
--------	--------	--------	-------------	-----------------------------	------------------------	----------------------	-----------------------------------	----------

Additional two magazines were retrieved from Cerio's patrol bag located on the passenger's front seat. Each magazine contained 15 rounds.

Ammunition: Issued--Speer 9mm

Nancy Pearlman:

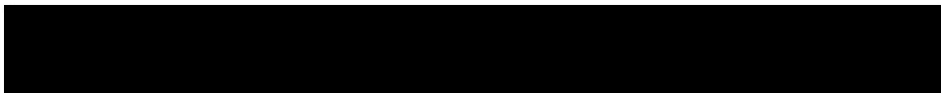

Loaded with one magazine containing 12 rounds and one in the chamber

Safety off

Ammunition: Winchester tips--9mm

Note: the third round from the bottom in the magazine contained a Federal lead nose jacket 9mm hollow-point.

Collected from the suspect's vehicle, located next to the suspect's left leg, on the driver's seat.

One magazine containing 40 caliber rounds

Collected from the center console.

EVIDENCE

The crime scene investigation recovered the following items at the scene of the shooting:

Seven 9mm shell casings—referring to the crime scene diagram, the shell casings were located at the following locations:

M4—9mm shell casing

M6—9mm shell casing

M4 & M6 were identified to belong to Sr. Deputy Stephens.

13 DATE TIME OF REPORT
04/25/03 10:14

14 REPORTING OFFICER / ID NO / DIV / UNIT
E. Montagna #1047 / Sgt.

15 APPROVED BY (ID NO)

NARRATIVE REPORT VENTURA COUNTY SHERIFF'S DEPARTMENT

Page 28 of 33 Continuation

AGENCY IDENTIFIER CA0560000

3281	30	05-8235
------	----	---------

4	5	6	7	8	9	10	11	12
DE	ITEM	QTY.	ITEM NAME	BRAND / MAKE MANUFACTURER	MODEL NAME OR NUMBER	MISC. DESCRIPTION	IDENTIFICATION / SERIAL NUMBER	VALUE

M7—9mm shell casing

M8—9mm shell casing

M7 & M8 were identified to belong to Sr. Deputy Stephens.

M9—9mm shell casing

M10—9mm shell casing

M11—9mm shell casing

M9, M10, & M11 were identified to belong to Deputy Cerio.

M1 revealed pieces of broken amber and clear plastic lens that belong to Sr. Deputy Stephens' patrol unit. An inspection of Stephens' patrol unit revealed damaged to the right front corner panel. The lens to the right front corner panel is missing. The pieces of broken lens collected at M1 appeared to belong to Stephens' vehicle. The damaged to Stephens' vehicle is consistent to the damage to the suspect's vehicle, which sustained minor damage to its left rear corner panel. Paint transfers were obtained from both Stephens' patrol unit and the suspect's car and booked into property.

M2 & M3 illustrate dirt furrows in the parking lot that is consistent with Stephens ramming the suspect's vehicle. Within the vicinity are pieces of broken plastic lens from Stephens' patrol unit found at M1.

M5 revealed pieces of broken glass consistent with the suspect's vehicle front passenger side window. Deputy Cerio reported, as soon as he heard the first two shots, he saw pieces of broken glass flying away from the suspect's passenger side door.

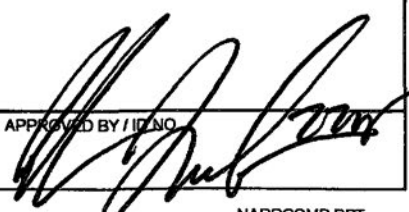
13 DATE TIME BY REPORT	14 REPORTING OFFICER / ID # / UNIT	15 APPROVED BY / ID #
04/25/03 10:14	E. Montagna #1047 / Sgt.	

NARRATIVE REPORT VENTURA COUNTY SHERIFF'S DEPARTMENT

Page 29 of 33 Continuation

AGENCY IDENTIFIER CA0560000

3201	3C	03-0235
------	----	---------

4 DE	5 ITEM	6 QTY.	7 ITEM NAME	8 BRAND / MAKE MANUFACTURER	9 MODEL NAME OR NUMBER	10 MISC. DESCRIPTION	11 IDENTIFICATION / SERIAL NUMBER	12 VALUE
------	--------	--------	-------------	-----------------------------	------------------------	----------------------	-----------------------------------	----------

A [REDACTED] was located next to the suspect on the driver's seat, between her left thigh and the door. The handgun was loaded with one round in the chamber, a full magazine, with the safety off.

A Glock magazine, .40 caliber, with twelve rounds was collected from the center console of the suspect's [REDACTED].

The following suspect's tires and rims were removed from the vehicle and booked into property. The suspect's vehicle was impounded and stored pending the investigation.

- L/R tire with paint transfers.
- L/R rim with two bullet strikes.

- R/F tire with an entry & exit bullet holes.
- R/F rim with one bullet strike.
- R/R tire with an entry & exit bullet holes.

Stephens' patrol car, vehicle #3338, was also transported to the Crime Lab. From the lab, the vehicle was taken to the County's El Rio garage--body shop. While at the body shop, the following parts were removed from the vehicle and booked into property. With the below parts removed, no other damaged was detected. The patrol car was released to the body shop for repairs.

- R/F fender
- R/F turn signal panel
- Front bumper

Photographs were taken by crime lab personnel that included the shooting scene, suspect's and patrol vehicles, autopsy, handguns and ammunitions. The photographs included the two bullet holes located in the suspect's driver's door and a single bullet hole in the suspect's vehicle front passenger side window. Crime lab personnel, that included Jim [REDACTED] Firearms Expert,

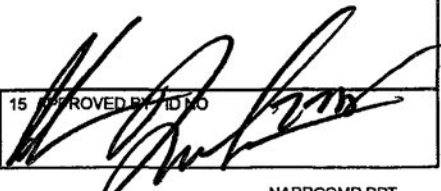
13 DATE TIME REPORT 04/29/03 10:14	14 REPORTING OFFICER ID # / UNIT E. Montagna #1047 / Sgt.	15 APPROVED BY ID NO 
---------------------------------------	--------------------------------------------------------------	---------------------------------------------------------------------------------------------------------------

NARRATIVE REPORT VENTURA COUNTY SHERIFF'S DEPARTMENT

Page 30 of 33 Continuation

AGENCY IDENTIFIER CA0560000

2 PD 3281	8 BEAT 3C	3 REPORT NUMBER 05-8235
--------------	--------------	----------------------------

4 TYPE	5 ITEM	6 QTY.	7 ITEM NAME	8 BRAND / MAKE MANUFACTURER	9 MODEL NAME OR NUMBER	10 MISC. DESCRIPTION	11 IDENTIFICATION / SERIAL NUMBER	12 VALUE
--------	--------	--------	-------------	-----------------------------	------------------------	----------------------	-----------------------------------	----------

examined the bullet holes in the suspect's vehicle and concluded the holes are consistent to the first two gunshots fired by Sr. Deputy Stephens.

13 DATE TIME OF REPORT
04/25/03 10:14

14 REPORTING OFFICER / ID NO / UNIT
E. Montagna #1047 / Sgt.

15 APPROVED BY / ID NO

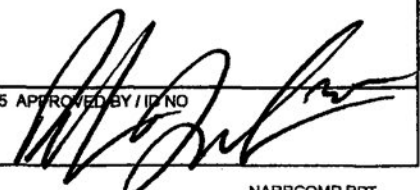

NARRATIVE REPORT VENTURA COUNTY SHERIFF'S DEPARTMENT

Page 31 of 33 Continuation

AGENCY IDENTIFIER CA0560000

1 PD 3261	2 BEAT 3C	3 REPORT NUMBER 03-8235
--------------	--------------	----------------------------

4 DE	5 ITEM	6 QTY.	7 ITEM NAME	8 BRAND / MAKE MANUFACTURER	9 MODEL NAME OR NUMBER	10 MISC. DESCRIPTION	11 IDENTIFICATION / SERIAL NUMBER	12 VALUE
------	--------	--------	-------------	-----------------------------	------------------------	----------------------	-----------------------------------	----------

Deputy Cerio's tape recording of the shooting incident:

A micro-cassette audio tape recorder was collected from the front seat of Deputy Cerio's patrol car. Deputy Cerio reported he activated his recorder shortly after he arrived at the parking lot. The tape recorder recorded the incident, which included statements by Sr. Deputy Stephens that were directed to the suspect, Stephens' statement that he saw the suspect with a gun, all of the gunshots, and statements between both deputies. The following is a summary of that tape recording:

Stephens' statements to the suspect:

Stephens attempts to communicate to the suspect, telling her that he is there to help her, pleading with her that he did not want her to hurt herself.

Cerio's statements to dispatch:

As Stephens was attempting to communicate with the suspect, Cerio informed dispatch that the suspect was not responding to Stephens' demands.

Stephens' statement to the suspect:

The recording revealed movement of the recorder, consistent to Deputy Cerio's statement that he got back into his vehicle as the suspect was moving. Seconds later, Stephens yelled at the suspect, "Put the gun down." Following this statement, two gunshots are heard. Stephens yells out, "Shots fired!"

Cerio's statement to dispatch:

Deputy Cerio informs dispatch that shots have been fired. Cerio requests backup units to assist.

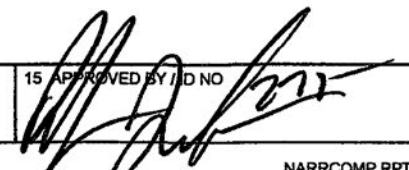
13 DATE/TIME OF REPORT 04/25/03 7:10:14	14 REPORTING OFFICER / ID NO. / DIV / UNIT E. Montagna #1047 / Sgt.	15 APPROVED BY / ID NO. 
--------------------------------------------	------------------------------------------------------------------------	------------------------------------------------------------------------------------------------------------------

NARRATIVE REPORT VENTURA COUNTY SHERIFF'S DEPARTMENT

Page 32 of 33 Continuation

AGENCY IDENTIFIER CA0560000

2 PD 3261	2 BEAT 3C	3 REPORT NUMBER 03-8235
--------------	--------------	----------------------------

4 CODE	5 ITEM	6 QTY.	7 ITEM NAME	8 BRAND / MAKE MANUFACTURER	9 MODEL NAME OR NUMBER	10 MISC. DESCRIPTION	11 IDENTIFICATION / SERIAL NUMBER	12 VALUE
--------	--------	--------	-------------	-----------------------------	------------------------	----------------------	-----------------------------------	----------

Additional sounds of gunshots:

Seconds after the first two gunshots, an additional series of gunshots, totaling five, could be heard. During this time, dispatch is attempting to communicate with the units.

Cerio's statement to dispatch:

Several seconds' later, Deputy Cerio contacts dispatch, requesting fire and ambulance to respond to the location. Cerio informs dispatch that the suspect has a head wound.

Dispatch and responding units:

Cerio's recorder continued to record communication between dispatch and responding units, and responding units communicating with each other.

13 DATE TIME OF REPORT
04/29/03 10:14

14 REPORTING OFFICER / ID NO. / DIV / UNIT
E. Montagna #1047 / Sgt.

15 APPROVED BY / ID NO.

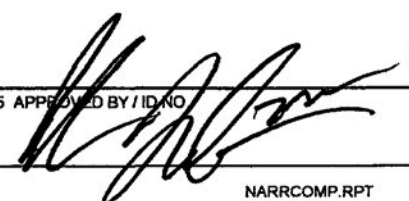

NARRATIVE REPORT VENTURA COUNTY SHERIFF'S DEPARTMENT

Page 33 of 33 Continuation

AGENCY IDENTIFIER CA0560000

2 PD 3261	3 BEAT 3C	3 RAN NUMBER 03-8235
--------------	--------------	-------------------------

4 CODE	5 ITEM	6 QTY.	7 ITEM NAME	8 BRAND / MAKE MANUFACTURER	9 MODEL NAME OR NUMBER	10 MISC. DESCRIPTION	11 IDENTIFICATION / SERIAL NUMBER	12 VALUE
--------	--------	--------	-------------	-----------------------------	------------------------	----------------------	-----------------------------------	----------

INJURIES

On 3-21-2003, Dr. O'Halloran, Ventura County Medical Examiner, performed an autopsy on the suspect. Sgt. Lorenzen and Detective Davidson were present during the autopsy and reported the following:

The suspect had a single entry gunshot wound to the lower outside corner of her left eye. There was no gunpowder stippling present. There were numerous small wounds peppered across the left side of her face, which O'Halloran determined to be consistent with injuries typically received from flying glass when a window is shattered. The wound is consistent to the two bullet holes located in the suspect's driver's side window. Crime Lab Technician [REDACTED], Firearms Expert, concluded one of the rounds hit the suspect and the other round had traveled through the interior of her vehicle and out the passenger's side window.

Additional wounds containing glass fragments were also located on her left neck and left shoulder areas. In addition, glass fragments were found on the back of her right hand near the base of the index finger and thumb. There was also another single wound, consistent with the other glass injuries, located on the inside of her right arm near the base of the thumb and slightly up the arm toward the forearm area.

The injuries appear to be consistent to Deputy Cerio's statements that he saw the suspect pointing a handgun at Sr. Deputy Stephens. Although Deputy Cerio could not recall what hand the suspect was holding the gun, the injuries are consistent to the suspect holding the handgun in her right hand and pointing the gun at Stephens.

CONCLUSION

Based upon the aforementioned facts, suspect Nancy Pearlman did point a handgun at Sr. Deputy Stephens. Sr. Deputy Stephens responded by yelling to the suspect to drop the gun. The suspect failed to respond to Stephens' demand. Sr. Stephens shot two rounds at the suspect, striking her once in the left side of her head. As a result of the gunshot injury, the suspect died.

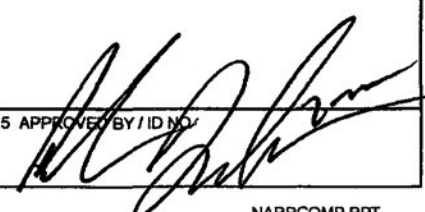
13 DATE/TIME OF REPORT 04/25/03 7:10:14	14 REPORTING OFFICER / ID NO. / DIV / UNIT E. Montagna #1047 / Sgt.	15 APPROVED BY / ID NO. 
--------------------------------------------	------------------------------------------------------------------------	------------------------------------------------------------------------------------------------------------------

CRIME / INCIDENT REPORT

VENTURA COUNTY SHERIFF'S DEPARTMENT

AGENCY IDENTIFIER CA0560000

CONNECTING REPORT NUMBERS		2 R.D.	3 BEAT	4 RB NUMBER						
		3262	3002	2003-8235						
<input type="checkbox"/> CRIME <input type="checkbox"/> INCIDENT <input checked="" type="checkbox"/> SUPPLEMENTAL <input type="checkbox"/> CASE CLEARED <input type="checkbox"/> _____		<input checked="" type="checkbox"/> DOMESTIC <input type="checkbox"/> CHILD ABUSE <input type="checkbox"/> HATE <input type="checkbox"/> GANG <input type="checkbox"/> ELDERLY ABUSE								
7 CODE SECTION / DESCRIPTION (INCIDENT) PC 417 (c) BRANISHING		8 CLASS. <input type="checkbox"/> Misd. <input checked="" type="checkbox"/> Fel.	9 CODE SECTION / DESCRIPTION (<input type="checkbox"/> Reclassify To)							
11 CODE SECTION / DESCRIPTION (INCIDENT)		12 CLASS. <input type="checkbox"/> Misd. <input type="checkbox"/> Fel.	13 CODE SECTION / DESCRIPTION (<input type="checkbox"/> Reclassify To)							
15 OCCURRED FROM MO. DAY YR. TIME		16 DOW	17 OCCURRED TO MO. DAY YR. TIME							
18 LOCATION OF OFFENSE / INCIDENT ADDRESS CITY STATE ZIP										
20 CODE: V- VICTIM W- WITNESS R- REPORTING PARTY F- FINDER O- OWNER P- PARTY										
21 CODE	22 NAME (Last, First, Middle, Gen.) / FIRM NAME	AKA / Moniker	RACE	SEX	25 HT	26 WT	27 HAIR	28 EYES	29 DOB	30 AGE
VI	STEPHENS JASON									
31 RESIDENCE ADDRESS / (<input type="checkbox"/> Same as Box # _____) CITY STATE ZIP							32 RESIDENCE PHONE () ()			
33 BUSINESS / SCHOOL NAME ADDRESS / (<input type="checkbox"/> Same as Box # _____) CITY STATE ZIP							34 BUSINESS PHONE () ()			
35 OCCUPATION (<input type="checkbox"/> STUDENT)			36 DAYS OFF		37 WORK HRS		38 INTERPRETER		39 OPERATOR'S LIC. NO. / STATE	
40 VEH. LIC. NO. / STATE		41 VEH. COLOR / YEAR / MAKE / MODEL / BODY STYLE				42 OTHER CHARACTERISTICS / VIN NO.				
43 CODE	44 NAME (Last, First, Middle, Gen.) / FIRM NAME	AKA / Moniker	RACE	SEX	47 HT	48 WT	49 HAIR	50 EYES	51 DOB	52 AGE
53 RESIDENCE ADDRESS / (<input type="checkbox"/> Same as Box # _____) CITY STATE ZIP							54 RESIDENCE PHONE () ()			
55 BUSINESS / SCHOOL NAME ADDRESS / (<input type="checkbox"/> Same as Box # _____) CITY STATE ZIP							56 BUSINESS PHONE () ()			
57 OCCUPATION (<input type="checkbox"/> STUDENT)			58 DAYS OFF		59 WORK HRS		60 INTERPRETER		61 OPERATOR'S LIC. NO. / STATE	
62 VEH. LIC. NO. / STATE		63 VEH. COLOR / YEAR / MAKE / MODEL / BODY STYLE				64 OTHER CHARACTERISTICS / VIN NO.				
65 ARSON		66 BURGLARY		68 THEFT		70 FORCE / WEAPON		72 SPECIAL INTEREST		
<input type="checkbox"/> Single Fam. Resd. <input type="checkbox"/> Inhabited <input type="checkbox"/> Uninhabited <input type="checkbox"/> Storage <input type="checkbox"/> Industrial <input type="checkbox"/> Commercial <input type="checkbox"/> Other Structure <input type="checkbox"/> Public Place <input type="checkbox"/> Vehicle <input type="checkbox"/> Unlawful Fire <input type="checkbox"/> Forest <input type="checkbox"/> Injury Occurred <input type="checkbox"/> Other		<input type="checkbox"/> Residential <input type="checkbox"/> Vehicle <input type="checkbox"/> Commercial <input type="checkbox"/> Other <input type="checkbox"/> Bank <input type="checkbox"/> Chain Store <input type="checkbox"/> Commercial <input type="checkbox"/> Gas Station <input type="checkbox"/> Highway <input type="checkbox"/> Residence <input type="checkbox"/> Other		<input type="checkbox"/> Auto Parts <input type="checkbox"/> Bicycle <input type="checkbox"/> From Bldg. <input type="checkbox"/> Coin Machine <input type="checkbox"/> From Person <input type="checkbox"/> From Vehicle <input type="checkbox"/> Purse Snatch <input type="checkbox"/> Shoplift <input type="checkbox"/> Other		<input type="checkbox"/> No Force <input type="checkbox"/> No Weapon <input type="checkbox"/> Verbal Only <input type="checkbox"/> Attempt Only <input type="checkbox"/> Great Bodily Injury <input type="checkbox"/> Firearm <input checked="" type="checkbox"/> Knife <input type="checkbox"/> Hands/Fists/Feet <input type="checkbox"/> Other		<input type="checkbox"/> (Copy to Agency/Unit) <input type="checkbox"/> Domestic Violence <input type="checkbox"/> Sex Crime <input type="checkbox"/> Child Abuse <input type="checkbox"/> PSSA <input type="checkbox"/> Gang Related <input type="checkbox"/> Hate Crime <input type="checkbox"/> Agricultural <input type="checkbox"/> Probation <input type="checkbox"/> Parole <input type="checkbox"/> Other		
69 VALUE / DOLLAR LOSS \$ _____				69 VALUE / DAMAGE LOSS \$ _____		71 DOMESTIC VIOLENCE / SEX / HATE CRIMES				
						<input type="checkbox"/> D.V. and/or S. A. Pamphlet given to: <input type="checkbox"/> Victim <input type="checkbox"/> P-1 <input type="checkbox"/> P-2 <input type="checkbox"/> Pursuant to Sec. 6254 G.C., victim of D.V., Sex or Hate Crime requests their name be <u>withheld</u> from the public. <input type="checkbox"/> YES <input type="checkbox"/> NO				
73 DATE AND TIME REPORTED		74 DATE / TIME OF REPORT		75 REPORTING OFFICER / ID NO. / DIV. / UNIT			76 APPROVED BY / ID NO.			
3-20-03 1849		3-21-03 0745		HINAWAY 2913 WCP / CAMPD			A. Joseph / 2486			
COPIES TO <input type="checkbox"/> DET / MC <input type="checkbox"/> NARC <input type="checkbox"/> GANG / SED <input type="checkbox"/> STATS <input type="checkbox"/> PRESS <input type="checkbox"/> DOJ <input type="checkbox"/> COURT <input type="checkbox"/> OTHER										

79 **ADDITIONAL NAME** (Complete Front Page First)

81 NAME (Last, First, Middle, Gen.) / FIRM NAME	AKA / Moniker	RACE 82	SEX 83	84 HT	85 WT	86 HAIR	87 EYES	88 DOB	89 AGE
-------------------------------------------------	---------------	------------	-----------	-------	-------	---------	---------	--------	--------

90 RESIDENCE ADDRESS / (Same as Box _____) CITY STATE ZIP

91 RESIDENCE PHONE ()

92 BUSINESS / SCHOOL NAME ADDRESS / (Same as Box _____) CITY STATE ZIP

93 BUSINESS PHONE ()

94 OCCUPATION (STUDENT)

95 DAYS OFF

96 WORK HRS

97 INTERPRETER

98 OPERATOR'S LIC. NO. / STATE

99 VEHICLE LIC. NO. / STATE

100 VEH. COLOR / YEAR / MAKE / MODEL / BODY STYLE

101 OTHER CHARACTERISTICS / VIN NO.

102 **DOMESTIC VIOLENCE** (PC 13700, 13730) * COMPLETE #70 & 71 ON FRONT PAGE

103 RESPONDED TO A CALL INVOLVING A DOMESTIC INCIDENT:

Parties involved are described in 13700 (B) PC and

Incident was verbal only, no evidence of crime, physical violence or traumatic condition existed. (brief narrative required) or

A misdemeanor (_____ PC) occurred and no prosecution was desired by any involved party.

A felony A misdemeanor arrest was made for (_____ PC)

Inquiry Per 13730 PC: Firearm / Deadly weapon

104 RELATIONSHIP OF PARTIES

SPOUSES FORMER SPOUSES

DATING/ ENGAGED FORMER DATING

COHABITANTS FORMER COHABITANT

PARENTS OF CHILD FROM RELATIONSHIP

105 # OF PRIOR RESPONSES? ALCOHOL/DRUG USE BY ABUSER? Yes No

106 **BICYCLE INFORMATION**

107 STOLEN LOST (Safekeeping, Found, Recovered, Evidence, use Property / Evidence Report)

108 Boys ATB Road Hybrid Girls Juv. BMX Cruiser

109 COLOR

110 MAKE / MODEL

111 FRAME SIZE

112 WHEEL SIZE

113 GEARS

114 SERIAL NUMBER

LICENSE NO. / CITY

116 ADDITIONAL EQUIPMENT OR IDENTIFYING CHARACTERISTICS

117 VALUE

118 **NARRATIVE**

If crime report, include brief description below (establishing elements of crime.) Use Narrative Report for details of crime List stolen / lost property (use format below.) Enter total value/dollar loss on #99 All suspect information on Suspect Report.

119 **PROPERTY CLASSIFICATION CODES**

SP - STOLEN PROPERTY LP - LOST PROPERTY

A - CURRENCY / NOTES D - VEHICLE G - FIREARMS J - LIVESTOCK

B - JEWELRY / PRECIOUS METALS E - OFFICE EQUIPMENT H - HOUSEHOLD GOODS K - MISCELLANEOUS

C - CLOTHING / FURS F - ELECTRONIC EQUIPMENT I - CONSUMABLE GOODS

120 CODE	121 ITEM	122 QTY.	123 ITEM NAME	124 BRAND / MAKE MANUFACTURER	125 MODEL / NAME OR NUMBER	126 MISC. DESCRIPTION	127 IDENTIFICATION / SERIAL NUMBER	128 VALUE
----------	----------	----------	---------------	-------------------------------	----------------------------	-----------------------	------------------------------------	-----------

ON 3-21-03, I WAS WORKING UNIFORM PATROL AND DRIVING A MARKED UNIT AS (3022).

I BEGAN MY SHIFT AT 0100 HOURS. AT 0123 HOURS, I RESPONDED TO PACIFIC COAST HIGHWAY TO RELIEVE DEPUTY MULROONEY. I ARRIVED AT THE LOCATION AT ABOUT 0145 HOURS. SERGEANT HANLEY (3519) DIRECTED ME TO RELIEVE DEPUTY SCHWIEDER (3052) WHO WAS ASSIGNED TRAFFIC CONTROL ON HIGHWAY 1 JUST NORTH OF MUGU ROCK.

I WAS CLEARED FROM THE INCIDENT AT 0450 HOURS.

NARRATIVE REPORT VENTURA COUNTY SHERIFF'S DEPARTMENT

Page 1 of 1 Continuation

AGENCY IDENTIFIER CA0560000

1 R.D. 3262	2 BEAT 3003	3 RB NUMBER 03-8235
----------------	----------------	------------------------

4 CODE	5 ITEM	6 QTY.	7 ITEM NAME	8 BRAND / MAKE MANUFACTURER	9 MODEL NAME OR NUMBER	10 MISC. DESCRIPTION	11 IDENTIFICATION / SERIAL NUMBER	12 VALUE
--------	--------	--------	-------------	-----------------------------	------------------------	----------------------	-----------------------------------	----------

- Supplemental Case Closed
- Gang Domestic Hate Child Abuse Elderly Abuse

Connecting Report Numbers:

Code Section / Description: Officer involved shooting Code Section / Description:
(Reclassify To:)

Code: Name: Perlman, Nancy
S

On 3-20-2003, Deputy McConville and I were assigned to the crime suppression unit working uniformed patrol in the city of Oxnard. At about 1855 hours, dispatch put out a broadcast of a suicidal subject. The subject's husband had advised his wife was depressed and suicidal and had left the house about 1-½ hours ago in a [redacted] armed with a handgun. Dispatched also advised that the subject was possibly en-route to Mugu Rock.

At about 1915 hours, we heard a unit advise that they had located the vehicle about ¼ mile past Mugu Rock and that the subject was being un-cooperative and not complying with deputies. At this time we started responding to Mugu Rock from the area of S. Oxnard Blvd and Date St. While en-route, Dispatched advised that the unit was advising that the Subject was attempting to flee in her vehicle. At this time we advised dispatch we were responding C-3. When we were in the area of Pacific Coast Highway and Las Posas Rd., dispatch advised that there were shots fired. We arrived at the location at about 1923 hours. We located the units in the parking lot of Point Mugu State Beach. As we pulled into the parking lot, I saw the [redacted] stopped on an embankment just south of the entrance. I saw Deputy Cerio at the open Driver's door of the vehicle and Deputy Stephens at the open passenger's door of the vehicle. We pulled in behind the [redacted] Deputy Stephens started walking back towards our unit and said, "She's 10-7." I asked him if it was self-inflicted. Deputy Stephens said, no, "I shot her."

At this time I called the watch commander (Captain LeMay) and advised him of the information I had. I then started securing the scene by taping off the area with crime scene tape.

At about 1930, Federal Fire Station 72 from Point Mugu arrived on scene. I escorted fireman [redacted] and Rick [redacted] to the scene. [redacted] went to the driver's door and [redacted] went to the passenger's door. At about 1933 hours, [redacted] pronounced Nancy Perlman dead. [redacted] then left his Blue latex gloves on the passenger floorboard.

Deputy McConville and I maintained security on the inner perimeter until approximately 2245 hours, when we were relieved by major crimes detectives.

13 DATE / TIME OF REPORT 3-21-03 / 0930	14 REPORTING OFFICER / ID NO / DIV / UNIT Heersche # 1312 / WCPS / CSU	15 APPROVED BY / ID NO A. Jorgensen / 12486
--------------------------------------------	---------------------------------------------------------------------------	------------------------------------------------

NARRATIVE REPORT VENTURA COUNTY SHERIFF'S DEPARTMENT

Page 1 of 2 Continuation

AGENCY IDENTIFIER CA0560000

1 R.D. 3270	2 BEAT 3C2	3 RB NUMBER 03-8235
----------------	---------------	------------------------

4 CODE	5 ITEM	6 QTY.	7 ITEM NAME	8 BRAND / MAKE MANUFACTURER	9 MODEL NAME OR NUMBER	10 MISC. DESCRIPTION	11 IDENTIFICATION / SERIAL NUMBER	12 VALUE
--------	--------	--------	-------------	-----------------------------	------------------------	----------------------	-----------------------------------	----------

Supplemental Case Closed

Gang Domestic Hate Child Abuse Elderly Abuse

Connecting Report Numbers:

Code Section / Description: Officer Involved Shooting.

Code: P Name: Pearlman, Nancy

Response to Scene

On 3-20-2003, at 1928 hours, I received a page with the telephone number to the Ventura County Sheriff Department watch Commander's office. I called the number and spoke to Captain L. [REDACTED]. [REDACTED] told me that there had been an officer involved shooting at Point Mugu State Park.

[REDACTED] said the involved Deputy was Jason Stephens and that he had shot a subject who was suicidal and armed with a gun. He added that the subject who was shot had expired at the scene.

I responded to the scene and arrived at 2000 hours. I attended an in-progress briefing being given by Commander D. Tennessen along with several other detectives and sheriff's personnel. During the briefing I learned that there were two deputies involved in the incident. Tennessen told us that the two deputies involved were Jason Stephens and Steven Cerio and that both of them had discharged their weapons during the incident.

13 DATE / TIME OF REPORT 4/1/2003 / 10:46 AM	14 REPORTING OFFICER / ID NO / DIV / UNIT J. Rivera / 2696 / WC / Special Services	15 APPROVED BY / ID NO <i>G. Montoya</i> / 1047
-------------------------------------------------	---------------------------------------------------------------------------------------	----------------------------------------------------

NARRATIVE REPORT VENTURA COUNTY SHERIFF'S DEPARTMENT

Page 2 of 2

Continuation

AGENCY IDENTIFIER CA0560000

1 R.D. 3270	2 BEAT 3C2	3 RB NUMBER 03-8235
----------------	---------------	------------------------

4 CODE	5 ITEM	6 QTY.	7 ITEM NAME	8 BRAND / MAKE MANUFACTURER	9 MODEL NAME OR NUMBER	10 MISC. DESCRIPTION	11 IDENTIFICATION / SERIAL NUMBER	12 VALUE
--------	--------	--------	-------------	-----------------------------	------------------------	----------------------	-----------------------------------	----------

After the briefing, I looked at the crime scene that included where the suspect's vehicle came to rest and where the two involved patrol cars were parked. After examining the crime scene, I conducted interviews with several Spanish-speaking witnesses. Refer to my supplemental reports for further details regarding those interviews.

I was also present while Sheriff's Personnel Sergeant B. Macedo exchanged the handguns that Stephens and Cerio used during used during this incident. Refer to my report regarding the exchange for further details.

I later participated in a walk-thru interview with Deputy Cerio. Refer to Sgt. Montagna's report for further details.

I concluded my investigation at 0430 hours and left the scene. No further details.

13 DATE / TIME OF REPORT 4/1/2003 / 10:46 AM	14 REPORTING OFFICER / ID NO / DIV / UNIT J. Rivera / 2696 / WC / Special Services	15 APPROVED BY / ID NO. <i>E. Montagna</i> / 1047
-------------------------------------------------	---------------------------------------------------------------------------------------	------------------------------------------------------

NARRATIVE REPORT VENTURA COUNTY SHERIFF'S DEPARTMENT

Page 1 of 1 Continuation

AGENCY IDENTIFIER CA0560000

1 R.D. 3261	2 BEAT 3C	3 RB NUMBER 03-8235
----------------	--------------	------------------------

4	5	6	7	8	9	10	11	12
PLATE	ITEM	QTY.	ITEM NAME	BRAND / MAKE MANUFACTURER	MODEL NAME OR NUMBER	MISC. DESCRIPTION	IDENTIFICATION / SERIAL NUMBER	VALUE

BEACH

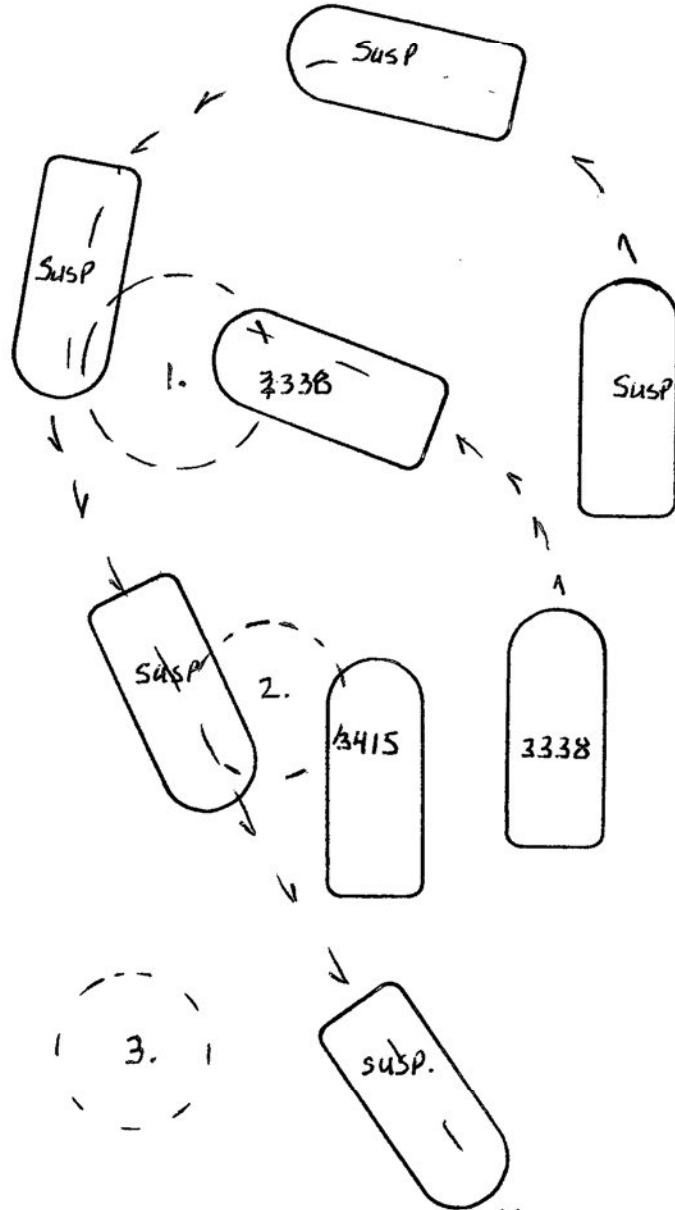

1. TWO GUNSHOTS INTO DRIVERS SIDE WINDOW.
2. TWO GUNSHOTS TO L/R RIM
3. THREE GUNSHOTS; TWO AT RIF RIM + TIRE ONE AT R/R TIRE.

3338 = STEPHENS
 3415 = CERIO
 SUSPECT = PEARLMAN

NOT TO SCALE

13 DATE / TIME OF REPORT
 4-16-03 / 1620

14 REPORTING OFFICER / ID NO / DIV / UNIT
 E. Montoya 1047

15 APPROVED BY / ID NO
 D. AGUILAR #2

Beach Area



LG 14

LG 15

Point Mugu State Park

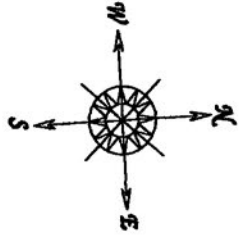

Beach Area

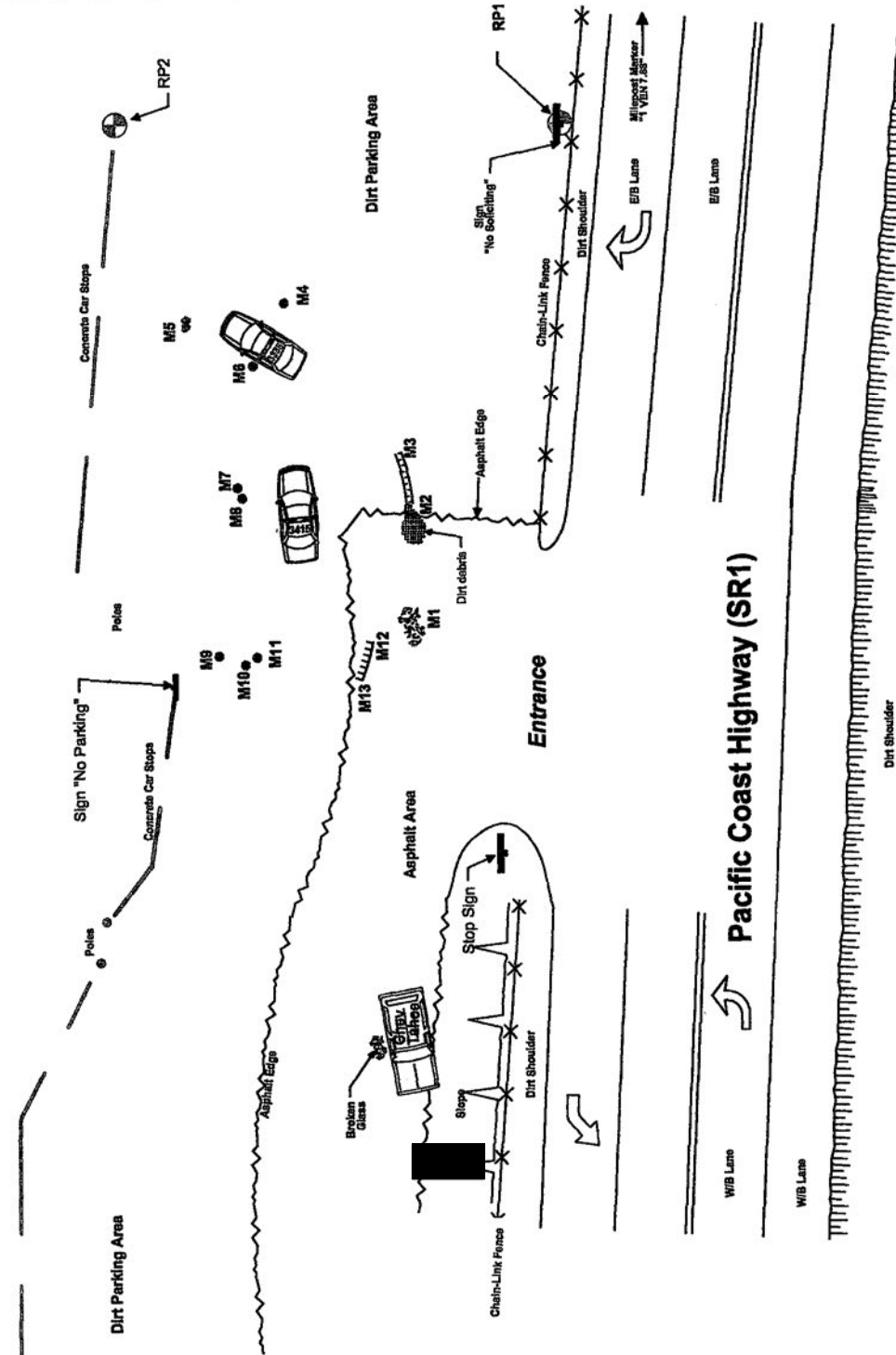

Legend

- M1- Broken Amber/Clear plastic lens
- M2- Dirt Furrow (start)
- M3- Dirt Furrow (end)
- M4- 9mm Casing
- M5- Broken Glass pieces
- M6- 9mm Casing
- M7- 9mm Casing
- M8- 9mm Casing
- M9- 9mm Casing
- M10- 9mm Casing
- M11- 9mm Casing
- M12- Accel Skid (start)
- M13- Accel Skid (end)

Scale



Case No: 2003-08235

Drawn by: Sr. Designer John Popp

Date: 03/24/2003

NARRATIVE REPORT VENTURA COUNTY SHERIFF'S DEPARTMENT

Page 1 of 2 Continuation

AGENCY IDENTIFIER CA0560000

1 R.D. 8003	2 BEAT 8A	3 RB NUMBER 2003-08235
-----------------------	---------------------	----------------------------------

4 CODE	5 ITEM	6 QTY.	7 ITEM NAME	8 BRAND / MAKE / MANUFACTURER	9 MODEL NAME OR NUMBER	10 MISC. DESCRIPTION	11 IDENTIFICATION / SERIAL NUMBER	12 VALUE
--------	--------	--------	-------------	-------------------------------	------------------------	----------------------	-----------------------------------	----------

Supplemental

On 3/20/2003 at approximately 2230 hours, I was called out reference an officer involved shooting scene at Point Mugu State Park, to diagram the scene. I arrived on scene at approximately 0035 hours. Upon arrival I contacted Sgt. Ernie Montagna. I was advised to diagram the scene of the parking lot and evidence within the scene. All measurements were taken using an LTI Impulse Laser measuring device.

DIAGRAM LEGEND

Vehicle measurements are to the center of each wheel, unless noted otherwise. All measurements were taken from Reference Line 1 (RL1) and Reference Line 2 (RL2). RL1 and RL2 create a Base Line within the scene. All measurements referred to as RL1 are east (+) and west (-) of the baseline of RL2. All measurements referred to as RL2 are north (+) and south (-) of the baseline of RL1.

Reference Point (RP1) was located at 849.25 ft east of the milepost Marker (1 Ven, 7.88) and 6.67 ft south of the south roadway edge of SR1 (Pacific Coast Highway).

Reference Point (RP2) was located at 849.25 ft east of the milepost Marker (1 Ven, 7.88) and 71.96 ft south of RP1.

(Measurements in feet)

PHYSICAL EVIDENCE

SCENE		<u>RL1</u>	<u>RL2</u>
M1	Broken Amber/Clear plastic lens	-80.64	22.79
M2	Dirt Furrow (Start)	-60.45	24.31
M3	Dirt Furrow (End)	-52.41	26.17
M4	9mm Casing	-28.08	44.67
M5	Broken glass pieces	-31.68	60.63
M6	9mm Casing	-38.08	49.77
M7	9mm Casing	-57.82	52.01
M8	9mm Casing	-59.43	51.51
M9	9mm Casing	-84.54	55.21
M10	9mm Casing	-85.95	50.84
M11	9mm Casing	-84.75	48.88
M12	Acceleration Skid (start)	-82.20	30.53
M13	Acceleration Skid (end)	-88.16	32.34

13 DATE / TIME OF REPORT

03/25/2003, 0700 hours

14 REPORTING OFFICER / ID NO / DIV / UNIT

J. Popp J. Popp 2277/Camarillo Traffic Unit

15 APPROVED BY / ID NO

[Signature] 1505

NARRATIVE REPORT VENTURA COUNTY SHERIFF'S DEPARTMENT

Page 2 of 2 Continuation

AGENCY IDENTIFIER CA0560000

1 R.D. 8003	2 BEAT 8A	3 RB NUMBER 2003-08235
-----------------------	---------------------	----------------------------------

4 CODE	5 ITEM	6 QTY.	7 ITEM NAME	8 BRAND / MAKE MANUFACTURER	9 MODEL NAME OR NUMBER	10 MISC. DESCRIPTION	11 IDENTIFICATION / SERIAL NUMBER	12 VALUE
--------	--------	--------	-------------	-----------------------------	------------------------	----------------------	-----------------------------------	----------

VEHICLES POINTS OF REST

RL1

RL2

Chevrolet

R/R (at taillight)
L/R (at taillight)

-139.05
-138.05

28.75
22.62

Unit # 3338

L/R
L/F

-39.20
-34.37

46.02
53.91

Unit # 3415

L/F
L/R

-56.66
-66.54

45.57
44.88

13 DATE / TIME OF REPORT 03/25/2003, 0700 hours	14 REPORTING OFFICER / ID NO / DIV / UNIT J. Popp 2277/Camarillo Traffic Unit	15 APPROVED BY / ID NO [Signature]
-----------------------------------------------------------	-----------------------------------------------------------------------------------------	----------------------------------------------

Mugu Rock
Rb# 2003-08235

Number	X	Y	Z	Note
1	0.00	0.00	0.00	"Control Point 1"
2	0.00	71.96	0.00	"Control Point 2"
3	-39.20	46.02	0.00	"UNIT3338 LR"
4	-34.37	53.91	0.00	"UNIT3338 LF"
5	-38.08	49.77	0.00	"MARKER 6 9MM CASING"
6	-31.68	60.63	0.00	"MARKER 5 GLASS PIECE"
7	-28.08	44.67	0.00	"MARKER 4 9MM CASING"
8	-60.45	24.31	0.00	"MARKER 2 ACCEL SKID ST"
9	-56.62	24.90	0.00	"ACCEL SKID MID"
10	-52.41	26.17	0.00	"MARKER 3 ACCEL SKID END"
11	-66.54	44.88	0.00	"UNIT 3415 LR"
12	-56.66	45.57	0.00	"UNIT 3415 LF"
13	-57.82	52.01	0.00	"MARKER 7 9MM CASING"
14	-59.43	51.51	0.00	"MARKER 8 9MM CASING"
15	-84.54	55.21	0.00	"MARKER 9 9MM CASING"
16	-85.95	50.84	0.00	"MARKER 10 9MM CASING"
17	-84.75	48.88	0.00	"MARKER 11 9MM CASING"
18	-82.20	30.53	0.00	"MARKER 12 ACCEL SKID ST"
19	-84.88	31.20	0.00	"ACCEL SKID MID"
20	-88.16	32.34	0.00	"MARKER 13 ACCEL SKID END"
21	-80.64	22.79	0.00	"MARKER 1 AMBER SIGNAL LENS"
22	-79.03	24.73	0.00	"MARKER 1 CLEAR LENS"
23	-139.05	28.75	0.00	"SUSP VEH RR TAIL LIGHT"
24	-138.05	22.62	0.00	"SUSP VEH LR TAIL LIGHT"
25	-153.41	48.45	0.00	"ASPHALT1"
26	-125.98	43.44	0.00	"ASPHALT2"
27	-100.79	35.04	0.00	"ASPHALT3"
28	-65.32	35.19	0.00	"ASPHALT4"
29	-62.16	34.31	0.00	"ASPHALT5"
30	-61.71	32.29	0.00	"ASPHALT6"
31	-63.75	3.33	0.00	"ASPHALT7 CHAINLINK FNCE"
32	-115.96	8.95	0.00	"STOP SIGN"
33	-123.47	6.56	0.00	"CHAINLINK FENCE POST"
34	-133.41	74.10	0.00	"RED POST 1"
35	-126.92	73.18	0.00	"RED POST 2"
36	-117.93	65.96	0.00	"CONC CAR STOP RED"
37	-91.04	62.37	0.00	"CONC CAR STOP RED2"
38	-89.49	62.43	0.00	"SIGN POST NO PRKG"
39	-82.22	68.60	0.00	"YELLOW POST 1"
40	-79.31	74.73	0.00	"YELLOW POST 2"
41	-73.29	73.92	0.00	"YELLOW POST 3"
42	-71.08	78.09	0.00	"CONC CAR STOPS"
43	50.80	-6.56	0.00	"CHAINLINK FENCE"

NARRATIVE REPORT VENTURA COUNTY SHERIFF'S DEPARTMENT

Page 4 of 5 Continuation

AGENCY IDENTIFIER CA0560000

1 R.D. 3261	2 BEAT 3C02	3 RB NUMBER 03-8235
----------------	----------------	------------------------

4 CODE	5 ITEM	6 QTY.	7 ITEM NAME	8 BRAND / MAKE MANUFACTURER	9 MODEL NAME OR NUMBER	10 MISC. DESCRIPTION	11 IDENTIFICATION / SERIAL NUMBER	12 VALUE
--------	--------	--------	-------------	-----------------------------	------------------------	----------------------	-----------------------------------	----------

Supplemental Case Closed

Gang Domestic Hate Child Abuse Elderly Abuse

Connecting Report Numbers:

Code Section / Description: Officer Involved Shooting

Reclassify To:

Code: P1 Name: Pearlman, Nancy

CRIME SCENE DESCRIPTION

On 3-20-03, at 1930 hours, I responded to Mugu State Beach, located on the Pacific Coast Highway (SR 1), un-incorp. Ventura County, California. I met with Sgt. Ernie Montagna who assigned me to complete a report that included a description of the scene and evidence collection. Field Evidence Technician Ian [REDACTED] and Eric [REDACTED] were at the location. Ian took overall photographs and video of the scene. They also placed photograph markers next to the items identified as evidence and took close-up photographs of each item. These items were later collected and booked as evidence at the Ventura County Crime Laboratory.

The weather was cool and although it was cloudy the air was dry. The breeze was moderate, blowing from north to south. The crime scene centered in the dirt/asphalt parking lot at Mugu State Beach located off the Pacific Coast Highway. The southbound shoulder of Pacific Coast Highway is paved.

13 DATE / TIME OF REPORT 04/21/03 11:04 AM	14 REPORTING OFFICER / ID NO / DIV / UNIT Detective D. Rubright, #1935/Special Services	15 APPROVED BY / ID NO <i>E. Montagna</i> 1047
--------------------------------------------------	--------------------------------------------------------------------------------------------	---------------------------------------------------

NARRATIVE REPORT VENTURA COUNTY SHERIFF'S DEPARTMENT

Page 2 of 5 Continuation

AGENCY IDENTIFIER CA0560000

1 R.D. 3261	2 BEAT 3C02	3 RB NUMBER 03-8235
----------------	----------------	------------------------

4 CODE	5 ITEM	6 QTY.	7 ITEM NAME	8 BRAND / MAKE MANUFACTURER	9 MODEL NAME OR NUMBER	10 MISC. DESCRIPTION	11 IDENTIFICATION / SERIAL NUMBER	12 VALUE
--------	--------	--------	-------------	-----------------------------	------------------------	----------------------	-----------------------------------	----------

Mugu State Beach is located south of Pacific Coast Highway, between the highway and the Pacific Ocean. The shooting incident occurred in the parking lot of Point Mugu State Beach, located between Mugu Rock and the Point Mugu Naval Air Base. The parking lot is located on the ocean side of Pacific Coast Highway, which accommodates for daytime parking only. A chain-link fence that is located along the ocean side of the Pacific Coast Highway encloses the parking lot. There is a single entrance to this area directly off of the Pacific Coast Highway. The parking lot is primarily hard dirt, asphalt and gravel. There is no lighting within the parking lot and there are no streetlights along the highway.

On the east side of the roadway, in this area of the Pacific Coast Highway, there is large rock categorized as Mugu Rock. On both the east and west sides of the rock are dirt parking lots. Mugu Rock is also an area for sightseers. Just east of the crime scene, prior to reaching Mugu Rock, is an extended parking area. North of the parking area is heavy brush with an embankment, which is progressively steeper, up to approximately twenty feet, as you near the parking area of Mugu Rock. In the area of the crime scene and several feet west of the crime scene there is no embankment only a flat surface leading to the shoulder of the Pacific Coast Highway. A slight embankment begins just east of the entrance to the parking lot.

Upon driving through the entrance, there is an asphalt area, which turns into a dirt parking area. South of the chain-link fence where the asphalt gives way to the dirt parking lot there is dirt debris and the beginning of a dirt furrow. The dirt furrow ends a few feet away. A few feet east of the dirt debris is broken pieces of the amber lighting and pieces of a clear plastic lens. From viewing the patrol vehicles,

13 DATE / TIME OF REPORT 04/21/03 11:04 AM	14 REPORTING OFFICER / ID NO / DIV / UNIT <i>DR</i> Detective D. Rubright, #1935/Special Services	15 APPROVED BY / ID NO <i>E. Montoya 1047</i>
-----------------------------------------------	------------------------------------------------------------------------------------------------------	--------------------------------------------------

NARRATIVE REPORT VENTURA COUNTY SHERIFF'S DEPARTMENT

Page 3 of 5 Continuation

AGENCY IDENTIFIER CA0560000

1 R.D. 3261	2 BEAT 3C02	3 RB NUMBER 03-8235
----------------	----------------	------------------------

4 CODE	5 ITEM	6 QTY.	7 ITEM NAME	8 BRAND / MAKE MANUFACTURER	9 MODEL NAME OR NUMBER	10 MISC. DESCRIPTION	11 IDENTIFICATION / SERIAL NUMBER	12 VALUE
--------	--------	--------	-------------	-----------------------------	------------------------	----------------------	-----------------------------------	----------

it appeared that the broken pieces of amber and lens came from Sr. Dep. Stephens' patrol vehicle, as the lens on the right front corner panel of his vehicle is missing. A few feet southeast of the broken debris is a skid mark. The skid appears to be an accelerated marking. The impression is a few feet long.

East of the entrance is the victim's vehicle, a [REDACTED]

[REDACTED] The vehicle came to rest on a berm adjacent to the chain-link fence along the Pacific Coast Highway. The vehicle was at a northeast direction.

The vehicle's engine was running and the headlights were on. The vehicle sustained damage to the front and rear driver's side fenders. It is unknown if the damage was caused from this incident or if some of the damage to the vehicle was caused on a previous occasion. Both tires on the right side of the suspect's vehicle were flat. There appeared to be a bullet hole in the front and rear passenger's side tire. There also appeared to be a bullet strike on the rear driver's side rim. Both the driver and passenger's doors were opened. The passenger's side window was smashed with a large hole in it. There were glass fragments on the ground on the passenger's side of the vehicle and there was glass within the vehicle. The driver's side window appeared to have two gunshot holes, which created a "spider" effect. The window was shattered, but still intact. On the passenger floorboard was a pair of blue latex gloves.

The victim, a red-haired, white female, was sitting in the driver's seat with her safety belt/shoulder strap securely fastened. The victim had an obvious gunshot wound to the left side of her head next to her left eye. There was blood on the victim's face (nose, mouth and right ear), body and seat. The victim was wearing a

13 DATE / TIME OF REPORT 04/21/03 11:04 AM	14 REPORTING OFFICER / ID NO / DIV / UNIT Detective D. Rubright, #1935/Special Services	15 APPROVED BY / ID NO <i>E. Morstyn</i> 1047
-----------------------------------------------	--------------------------------------------------------------------------------------------	--------------------------------------------------

NARRATIVE REPORT VENTURA COUNTY SHERIFF'S DEPARTMENT

Page 4 of 5 Continuation

AGENCY IDENTIFIER CA0560000

1 R.D. 3261	2 BEAT 3C02	3 RB NUMBER 03-8235
----------------	----------------	------------------------

4 CODE	5 ITEM	6 QTY.	7 ITEM NAME	8 BRAND / MAKE MANUFACTURER	9 MODEL NAME OR NUMBER	10 MISC. DESCRIPTION	11 IDENTIFICATION / SERIAL NUMBER	12 VALUE
--------	--------	--------	-------------	-----------------------------	------------------------	----------------------	-----------------------------------	----------

blue button-up short-sleeved sweater. The shirt had bloodstains and streaks on the front. She was also wearing white pants, possibly jeans. The pants had bloodstains in the torso area and there also appeared to be glass fragments in the torso area. The victim was wearing a pair of yellow metal earrings. The left earring was stained with blood. She was wearing a necklace, which again there appeared to be a large amount of blood on it. The victim had a black purse, which was lying on the front passenger seat.

On the seat directly next to her left thigh was a black semi-automatic handgun. The top of the barrel of the gun was lying against the seat of the SUV with the opening of the barrel pointing towards the dashboard. The handle of the handgun was facing upward and was leaning against the victim's left arm. The handgun was later determined to be loaded, with a round in the chamber, a full magazine, and the safety was off.

The patrol vehicle #3338, driven by Sr. Dep. Jason Stephens, sustained moderate damage to the right front bumper. Early investigation determined Sr. Stephens caused this when he used legal intervention in attempts to make the victim stop her vehicle. When observing the crime scene, I saw that Sr. Stephens' vehicle was in the dirt parking area. The patrol vehicle was facing the ocean in a southwest direction. The vehicle was approximately forty-feet from the chain-link fence. Approximately three feet from the front passenger door, on the dirt lot, was a 9MM casing. Approximately one foot from the driver's door, on the dirt lot, was another 9MM casing. Located several feet in front of the patrol vehicle, closest to the left front bumper, were pieces of broken glass.

13 DATE / TIME OF REPORT 04/21/03 11:04 AM	14 REPORTING OFFICER / ID NO / DIV / UNIT SP Detective D. Rubright, #1935/Special Services	15 APPROVED BY / ID NO <i>E. Morstein</i> 1047
-----------------------------------------------	-----------------------------------------------------------------------------------------------	---------------------------------------------------

NARRATIVE REPORT VENTURA COUNTY SHERIFF'S DEPARTMENT

Page 5 of 5 Continuation

AGENCY IDENTIFIER CA0560000

1 R.D. 3261	2 BEAT 3C02	3 RB NUMBER 03-8235
----------------	----------------	------------------------

4 CODE	5 ITEM	6 QTY.	7 ITEM NAME	8 BRAND / MAKE MANUFACTURER	9 MODEL NAME OR NUMBER	10 MISC. DESCRIPTION	11 IDENTIFICATION / SERIAL NUMBER	12 VALUE
--------	--------	--------	-------------	-----------------------------	------------------------	----------------------	-----------------------------------	----------

The patrol vehicle #3415, driven by Dep. Steve Cerio, sustained minor damage to the driver's side door when the victim's vehicle came in contact with his vehicle. The vehicle's engine was running. The overhead red/blue lights were on along with the headlights. Dep. Cerio's vehicle was approximately ten to fifteen feet behind Sr. Dep. Stephens' patrol vehicle.

Approximately seven feet from the left front tire of vehicle #3415 was a 9MM casing. A fifth 9MM casing was found just east of that casing approximately six feet from the patrol vehicle. Located east to the rear of Dep. Cerio's vehicle were three more casings. These three casings were within approximately seven feet of each other.

Ventura County Field Evidence Technicians photographed the crime scene, identified and marked items of evidence and collected them. These items of evidence were later booked into the Ventura County Property Room. In addition, the victim's vehicle and Sr. Dep. Stephen's patrol vehicle #3338 were also transported to the Sheriff's Crime Lab. Refer to the property technicians' reports for further details on the complete description of the items seized at the crime scene.

13 DATE / TIME OF REPORT 04/21/03 11:04 AM	14 REPORTING OFFICER / ID NO / DIV / UNIT SRD Detective D. Rubright, #1935/Special Services	15 APPROVED BY / ID NO <i>S. Montagna 1087</i>
-----------------------------------------------	------------------------------------------------------------------------------------------------	---------------------------------------------------

NARRATIVE REPORT VENTURA COUNTY SHERIFF'S DEPARTMENT

Page 1 of 2

Continuation

AGENCY IDENTIFIER CA0560000

1 R.D. 3267	2 BEAT 3C02	3 RB NUMBER 03-008235
----------------	----------------	--------------------------

4 CODE	5 ITEM	6 QTY.	7 ITEM NAME	8 BRAND / MAKE MANUFACTURER	9 MODEL NAME OR NUMBER	10 MISC. DESCRIPTION	11 IDENTIFICATION / SERIAL NUMBER	12 VALUE
--------	--------	--------	-------------	-----------------------------	------------------------	----------------------	-----------------------------------	----------

Supplemental Case Cleared

Gang Domestic Hate Child Abuse Elderly Abuse

Connecting Report Numbers:

Code Section / Description: Officer Involved Shooting

Reclassify To:

Code: **Name:**

Witness Interview 03/20/03

Senior Deputy Jason Stephens
Ventura County Sheriff's Department

On 03/20/03, I was assisting in the investigation of a shooting involving two on-duty Ventura County Sheriff's Deputies that occurred in the north public beach parking area of Mugu Rock. The female shooting victim had died at the scene apparently from a gunshot wound to the head.

At about 2025 hours, I spoke with Senior Deputy Jason Stephens, who was seated on the right rear passenger seat of Sergeant John Miller's unmarked patrol vehicle. Sergeant Miller's vehicle was parked facing south on the west shoulder of Pacific Coast Highway, about 100 feet north of the entrance to the north parking lot of Mugu Rock. Sergeant Miller was seated on the driver's seat of the vehicle and he witnessed the interview. Senior Deputy Stephens was involved in the shooting and my questions were limited to public safety concerns surrounding the shooting. The interview was not recorded.

I asked Senior Deputy Stephens if he recalled how many shots he had fired during the incident. Senior Deputy Stephens motioned to his patrol car, which was parked in the north parking lot of Mugu Rock, approximately 50 feet north of the entrance to the parking lot and was facing in a northwesterly direction. Senior Deputy Stephens said that the suspect vehicle, and he motioned to a [REDACTED] that was resting facing south against the east berm of the north parking lot of Mugu Rock, about 30 feet south of the entrance to the parking lot, drove south through the parking lot past the front of his patrol car. As the vehicle passed his patrol car he fired two shots from his service pistol at the vehicle's driver.

13 DATE / TIME OF REPORT

03/25/03/ 8:31 AM

14 REPORTING OFFICER / ID NO / DIV / UNIT

Sgt. W. Ayub/#3318/Special Services

15 APPROVED BY / ID NO

E. Montoya 1047

NARRATIVE REPORT VENTURA COUNTY SHERIFF'S DEPARTMENT

Page 2 of 2

Continuation

AGENCY IDENTIFIER CA0560000

1 R.D.
3267

2 BEAT
3C02

3 RB NUMBER
03-008235

4 CODE	5 ITEM	6 QTY.	7 ITEM NAME	8 BRAND / MAKE MANUFACTURER	9 MODEL NAME OR NUMBER	10 MISC. DESCRIPTION	11 IDENTIFICATION / SERIAL NUMBER	12 VALUE
--------	--------	--------	-------------	-----------------------------	------------------------	----------------------	-----------------------------------	----------

Senior Deputy Stephens said he was partially seated in his patrol car and he was facing in a northwesterly direction when he fired the two shots. He also said his vehicle was in "drive" and his foot was on the brake when the shooting occurred. He believes that his vehicle may have rolled forward slightly during the shooting.

Senior Deputy Stephens said the vehicle continued southbound past his patrol car and he thought the driver was going to flee. He then yelled to his partner, Deputy Stephen Cerio, who had arrived to assist him, that he was going to "blow the tires". Senior Deputy Stephens said he then fired 1 to 2 shots from his service pistol at the vehicle's left rear tire. At the same time, he heard Deputy Cerio fire 1 or 2 shots at the suspect vehicle's right front tire.

Senior Deputy Stephens said the empty beach and ocean were the backdrops when he fired at the vehicle's driver and both he and Deputy Cerio fired their weapons toward the ground when they shot at the vehicle's tires. He did not feel that anyone not involved in the incident had been placed in jeopardy.

I asked Senior Deputy Stephens if he believed that the person he shot at had a weapon and, if so, where it was. He told me that the driver of the suspect vehicle, who was the sole occupant, had a handgun and that it was in the vehicle with her.

I concluded the interview with Senior Deputy Stephens and left him with Sergeant Miller.

13 DATE / TIME OF REPORT 03/25/03/ 8:31 AM	14 REPORTING OFFICER / ID NO / DIV / UNIT Sgt. W. Ayub/#3318/Special Services	15 APPROVED BY / ID NO <i>S. Montefino</i> 1047
-----------------------------------------------	----------------------------------------------------------------------------------	----------------------------------------------------

NARRATIVE REPORT VENTURA COUNTY SHERIFF'S DEPARTMENT

Page 1 of _____ Continuation

AGENCY IDENTIFIER CA0560000

1 R.D. 3261	2 BEAT 3C	3 RB NUMBER 03-8235
----------------	--------------	------------------------

4 CODE	5 ITEM	6 QTY.	7 ITEM NAME	8 BRAND / MAKE MANUFACTURER	9 MODEL NAME OR NUMBER	10 MISC. DESCRIPTION	11 IDENTIFICATION / SERIAL NUMBER	12 VALUE
--------	--------	--------	-------------	-----------------------------	------------------------	----------------------	-----------------------------------	----------

Supplemental Case Cleared

Gang Domestic Hate Child Abuse Elderly Abuse

Connecting Report Numbers:

Code Section / Description: OFFICER INVOLVED SHOOTING

Code: VICTIM Name: STEPHENS, JASON

**TRANSCRIPTION
CERIO'S MICROCASSETTE RECORDING**

Stephens: I [redacted] want you to hurt yourself.
Nancy. I can help...meet with...doctor.

Pearlman: **Inaudible...sounds like "no".**

Stephens: Nancy. This isn't the way. This is not the answer.
Pause.
Do you hear me.
Pause...some inaudible radio traffic and vehicular traffic in the background.

Cerio Station One. 3D51.

Dispatch 3D51.

Stephens Nancy. There are a lot of people that love you. They [redacted]s want to see you die.

Cerio Subject is still not complying...

Dispatch 3D51. I copy. Subject is not complying, refusing to come out of vehicle.
More radio traffic.

Stephens Nancy. Do me a favor and roll down the window all the way so that I can hear you.
More radio traffic in background.

13 DATE / TIME OF REPORT 04/29/03 / 14:14	14 REPORTING OFFICER / ID NO / DIV / UNIT E. Montagna #1047 / Sgt.	15 APPROVED BY / ID NO
----------------------------------------------	-----------------------------------------------------------------------	------------------------

NARRATIVE REPORT VENTURA COUNTY SHERIFF'S DEPARTMENT

Page 2 of Continuation

AGENCY IDENTIFIER CA0560000

1 R.D. 3261	2 BEAT 3C	3 RB NUMBER 03-8235
----------------	--------------	------------------------

4 CODE	5 ITEM	6 QTY.	7 ITEM NAME	8 BRAND / MAKE MANUFACTURER	9 MODEL NAME OR NUMBER	10 MISC. DESCRIPTION	11 IDENTIFICATION / SERIAL NUMBER	12 VALUE
--------	--------	--------	-------------	-----------------------------	------------------------	----------------------	-----------------------------------	----------

Dispatch 3D51. I copy the subject not complying, refusing to come out. Advise your 10-20.

Stephens Nancy.

Vehicles are moving at this time. Cerio places recorder inside his vehicle. Sounds of a car door alarm in background.

Pause

Stephens Put the gun down.

Two gunshots can be heard.

Stephens Shots fired.

Ceiro Shots fired. Shots fired. Need assistance. Car rolling.

More radio traffic...

Five gunshots can be heard.

Pause

Dispatch 3C51. Advise your 20 (location).

More radio traffic....

Cerio Station One. 3D51. Roll fire and ambulance. Shots fired. Subject has a head wound.

Pause

More radio traffic...

Cerio Do you need anything else?

Dispatch 3D51
3D51

More radio traffic in background. Sirens heard in background.

5G11 Station One. 5 George 11. 10-97.

13 DATE / TIME OF REPORT 04/29/03 / 14:14	14 REPORTING OFFICER / ID NO / DIV / UNIT E. Montagna #1047 / Sgt.	15 APPROVED BY / ID NO
----------------------------------------------	-----------------------------------------------------------------------	------------------------

NARRATIVE REPORT VENTURA COUNTY SHERIFF'S DEPARTMENT

Page 3 of Continuation

AGENCY IDENTIFIER CA0560000

1 R.D. 3261	2 BEAT 3C	3 RB NUMBER 03-8235
----------------	--------------	------------------------

4 CODE	5 ITEM	6 QTY.	7 ITEM NAME	8 BRAND / MAKE MANUFACTURER	9 MODEL NAME OR NUMBER	10 MISC. DESCRIPTION	11 IDENTIFICATION / SERIAL NUMBER	12 VALUE
--------	--------	--------	-------------	-----------------------------	------------------------	----------------------	-----------------------------------	----------

Station One. 5 George 11. 10-97.

Dispatch 5 George 11. 10-7. Confirming the suspect has a head wound.

Sirens heard in background.

Radio traffic continues.....Units arriving on scene.....

13 DATE / TIME OF REPORT
04/29/03 / 14:14

14 REPORTING OFFICER / ID NO / DIV / UNIT
E. Montagna #1047 / Sgt.

15 APPROVED BY / ID NO

NARRATIVE REPORT VENTURA COUNTY SHERIFF'S DEPARTMENT

Page 1 of 3

Continuation

AGENCY IDENTIFIER CA0560000

1 R.D. 3261	2 BEAT 3C02	3 RB NUMBER 03-8235
----------------	----------------	------------------------

4 CODE	5 ITEM	6 QTY.	7 ITEM NAME	8 BRAND / MAKE MANUFACTURER	9 MODEL NAME OR NUMBER	10 MISC. DESCRIPTION	11 IDENTIFICATION / SERIAL NUMBER	12 VALUE
--------	--------	--------	-------------	-----------------------------	------------------------	----------------------	-----------------------------------	----------

- Supplemental Case Cleared
 Gang Domestic Hate Child Abuse Elderly Abuse

Connecting Report Numbers:

Code Section / Description: Officer Involved Shooting

Reclassify To:

Code: W **Name:** [REDACTED]

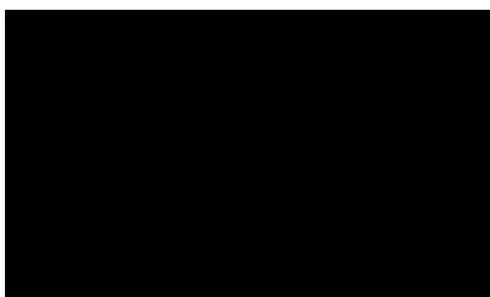

On 3/20/2003, at approximately 2120 hours, I was directed to assist with interviews of possible witnesses to the officer involved shooting. I contacted [REDACTED] and her boyfriend, [REDACTED] in the parking lot area of Point Mugu State Beach. Since [REDACTED] spoke Spanish, Detective Rivera to interviewed [REDACTED]

The following is a summary of my interview with [REDACTED] lives in Oxnard and is employed at Elm Street Elementary School in Oxnard. [REDACTED] is [REDACTED] boyfriend and they came to the beach earlier to have dinner with one another. [REDACTED] came to the beach in [REDACTED] godfather's vehicle, license [REDACTED] I noticed the vehicle had been backed into the stall and the vehicle was located in the east portion of the parking lot area.

[REDACTED] arrived at the beach, at approximately 1800 hours and parked where their vehicle was now located. They had backed the vehicle in, so that they could sit on the tailgate and eat their dinner.

13 DATE / TIME OF REPORT 04/01/03/ 10:53 AM	14 REPORTING OFFICER / ID NO / DIV / UNIT Sgt. M. Smith/#2622/Special Services	15 APPROVED BY / ID NO <i>[Signature]</i> 1047
------------------------------------------------	-----------------------------------------------------------------------------------	---------------------------------------------------

NARRATIVE REPORT VENTURA COUNTY SHERIFF'S DEPARTMENT

Page 2 of 3

Continuation

AGENCY IDENTIFIER CA0560000

1 R.D.
3261

2 BEAT
3C02

3 RB NUMBER
03-8235

4 CODE	5 ITEM	6 QTY.	7 ITEM NAME	8 BRAND / MAKE MANUFACTURER	9 MODEL NAME OR NUMBER	10 MISC. DESCRIPTION	11 IDENTIFICATION / SERIAL NUMBER	12 VALUE
--------	--------	--------	-------------	-----------------------------	------------------------	----------------------	-----------------------------------	----------

While sitting on the tailgate, [REDACTED] noticed the police unit traveling west within the Point Mugu State Beach parking lot. [REDACTED] thought it was odd to see the police at this time of night and even made the comment to [REDACTED] how she found it strange for the police to be there at that time. [REDACTED] noticed the unit's red and blue lights through the camper shell as it traveled west through the parking lot but so no other vehicle in front of the unit. Neither [REDACTED] nor [REDACTED] had seen the unit approach their location when it traveled east into the parking area. [REDACTED] didn't see any other vehicles besides the patrol unit at this point. [REDACTED] said that the only reason they noticed the patrol car from their vantage point on the tailgate was because the unit's red and blue lights were activated and were visible through the shell of the truck.

[REDACTED] saw the police unit traveling slowly through the parking lot. [REDACTED] told [REDACTED] that she needed to use the restroom. [REDACTED] began to walk to the restrooms and got to the area approximately forty yards east of Lifeguard Tower #14 and noticed two units had stopped a [REDACTED] said that it appeared as though one of the patrol units was behind the SUV and the other was on the side of the SUV. [REDACTED] said the SUV and units were situated near the closest "No Parking" sign to us near the parking lot entrance. The SUV was facing in a slanted southwest position and the patrol unit was facing in a northwest direction at a 90-degree angle. When I asked [REDACTED] to show me how the SUV and the unit were parked, she demonstrated that the SUV was parked in a slanted southeast direction and the unit was situated in a southwest position. During the interview, [REDACTED] made the comment that the SUV was trying to move and the unit was making contact with the SUV. [REDACTED] said the SUV was pushing against the unit and that the patrol unit was making contact with the SUV, 3/4 of the way down the side of the SUV near the left rear tire.

[REDACTED] then heard two shots. At first, [REDACTED] said the first two shots were 10 seconds apart. In an attempt to better assess the time frame for the first two shots, I had [REDACTED] show me in real time how far apart the shots were. After doing this, I felt the first two rounds had been fired closer together, less than five seconds apart.

13 DATE / TIME OF REPORT 04/01/03/ 10:53 AM	14 REPORTING OFFICER / ID NO / DIV / UNIT Sgt. M. Smith/#2622/Special Services	15 APPROVED BY / ID NO <i>[Signature]</i> 104
------------------------------------------------	-----------------------------------------------------------------------------------	--------------------------------------------------

NARRATIVE REPORT VENTURA COUNTY SHERIFF'S DEPARTMENT

Page 3 of 3 Continuation

AGENCY IDENTIFIER CA0560000

1 R.D.
8261

2 BEAT
3C02

3 RB NUMBER
03-8235

4 CODE	5 ITEM	6 QTY.	7 ITEM NAME	8 BRAND / MAKE MANUFACTURER	9 MODEL NAME OR NUMBER	10 MISC. DESCRIPTION	11 IDENTIFICATION / SERIAL NUMBER	12 VALUE
--------	--------	--------	-------------	-----------------------------	------------------------	----------------------	-----------------------------------	----------

When [REDACTED] heard the first two shots, the SUV had spun around and was traveling in an eastbound direction. After the first two shots, a few seconds passed before she heard three shots in pretty rapid succession. I asked [REDACTED] how much time had expired from the first time she saw the patrol unit to the last shot being fired. [REDACTED] said it felt like a long time but understands it could have been about five or six minutes. [REDACTED] said when you're scared it seems longer.

After hearing the first two shots, [REDACTED] and [REDACTED] took cover behind some bushes. [REDACTED] then heard another three more rounds for a total of five shots. [REDACTED] then heard the sound of sirens of more police cars approaching and saw lights. [REDACTED] got up before [REDACTED]. After [REDACTED] got up she observed the SUV in its current location.

[REDACTED] said she couldn't see any officers during this entire incident but spoke in the plural as if there were more than one officer. [REDACTED] said she heard officer's voices, similar to what you hear on television, "put your hands up" or something like that. [REDACTED] heard various yells, meaning she could differentiate there was more than one officer. [REDACTED] first heard yelling as she observed the unit making contact with the SUV. In between the first and second shots, [REDACTED] again heard some yelling.

I asked [REDACTED] what other vehicles were in the area where she and [REDACTED] were parked. [REDACTED] said there was another white car and two additional cars parked east of them.

End of interview

13 DATE / TIME OF REPORT
04/01/03/ 10:53 AM

14 REPORTING OFFICER / ID NO / DIV / UNIT
Sgt. M. Smith/#2622/Special Services *MS*

15 APPROVED BY / ID NO
E. Montagna-1017

NARRATIVE REPORT VENTURA COUNTY SHERIFF'S DEPARTMENT

Page 1 of 5 Continuation

AGENCY IDENTIFIER CA0560000

1 R.D.
3270

2 BEAT
3C2

3 RB NUMBER
03-8235

4. DATE	5. ITEM	6. QTY.	7. ITEM NAME	8. BRAND / MAKE MANUFACTURER	9. MODEL NAME OR NUMBER	10. MISC. DESCRIPTION	11. IDENTIFICATION / SERIAL NUMBER	12. VALUE
---------	---------	---------	--------------	------------------------------	-------------------------	-----------------------	------------------------------------	-----------

Supplemental Case Closed

Gang Domestic Hate Child Abuse Elderly Abuse

Connecting Report Numbers:

Code Section / Description: Officer Involved Shooting

Code: S Name: Pearlman, Nancy

Interview with

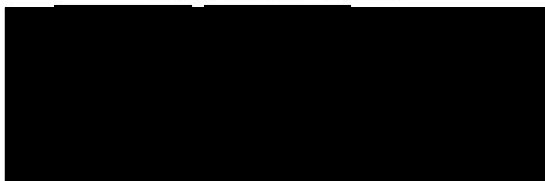

On 3-20-2003, I interviewed [REDACTED] who was sitting in a white compact near the crime scene. My interview with [REDACTED] was conducted in Spanish and the following is a synopsis. The interview was recorded and the audiotape was later booked as evidence.

[REDACTED] said she and her boyfriend were parked towards the top of the parking lot (south/ east end). She pointed to a white truck with a camper that was still parked at the top of the parking lot. She said they were parked to one side of that truck.

[REDACTED] said she and her boyfriend were parked facing the ocean. She said she saw the "Sheriff" arrive and shine it's lights at the "truck." [REDACTED] said she did not know what direction the Sheriff's unit came from because she was eating.

13 DATE / TIME OF REPORT 4/1/2003 / 10:45 AM	14 REPORTING OFFICER / ID NO / DIV / UNIT J. Rivera / 2696 / WC / Special Services	15 APPROVED BY / ID NO <i>E. Montoya</i> / 1047
-------------------------------------------------	---------------------------------------------------------------------------------------	----------------------------------------------------

NARRATIVE REPORT VENTURA COUNTY SHERIFF'S DEPARTMENT

Page 2 of 5

Continuation

AGENCY IDENTIFIER CA0560000

1 R.D. 3270	2 BEAT 3C2	3 RB NUMBER 03-8235
----------------	---------------	------------------------

4 CODE	5 ITEM	6 QTY.	7 ITEM NAME	8 BRAND / MAKE MANUFACTURER	9 MODEL NAME OR NUMBER	10 MISC. DESCRIPTION	11 IDENTIFICATION / SERIAL NUMBER	12 VALUE
--------	--------	--------	-------------	-----------------------------	------------------------	----------------------	-----------------------------------	----------

I asked Mergola if the Sheriff's unit had its emergency lights on. She said, "Yes." Mergola said she looked at the truck [redacted] and it backed up without turning on its lights. She said the "Sheriff" followed the [redacted]

I asked Mergola where the [redacted] was when it backed up. She pointed to the location where Stephens and Cerio's patrol car were located. She said it was in front of the patrol car that had the lights flashing. Mergola told me she was not sure whether the [redacted] backed up or what direction it was moving. She said one of the patrol cars struck the [redacted] on the driver's side.

Mergola said it was after that point that she heard the shots being fired. I asked her if she knew who had fired the shots. Mergola told me, "No." She told me she heard the shots fired and then saw the truck come to rest at its present location. Mergola pointed over to the [redacted] located a short distance away from us.

I asked Mergola how many shots she heard being fired. Mergola said she was not sure but thought it was more than three. I asked Mergola if she looked over to see what was happening when she heard the gunshots. Mergola said she looked over after hearing the gunshots and saw the [redacted] traveling to the location where it came to rest. Mergola said she heard several more shots before the [redacted] came to rest.

I asked Mergola if the truck was traveling at a slow or high speed as it reached its resting spot. She said it was traveling slowly. I asked Mergola what the officers did after the [redacted] came to rest. She told me that she could not see from her position. I asked Mergola if she saw the officers around the [redacted] and she said,

13 DATE / TIME OF REPORT 4/1/2003 / 10:45 AM	14 REPORTING OFFICER / ID NO / DIV / UNIT J. Rivera / 2696 / WC / Special Services	15 APPROVED BY / ID NO E. Montoya / 1047
-------------------------------------------------	---------------------------------------------------------------------------------------	---------------------------------------------

NARRATIVE REPORT VENTURA COUNTY SHERIFF'S DEPARTMENT

Page 3 of 5

Continuation

AGENCY IDENTIFIER CA0560000

1 R.D. 3270	2 BEAT 3C2	3 RB NUMBER 03-8235
----------------	---------------	------------------------

4 DE	5 ITEM	6 QTY.	7 ITEM NAME	8 BRAND / MAKE MANUFACTURER	9 MODEL NAME OR NUMBER	10 MISC. DESCRIPTION	11 IDENTIFICATION / SERIAL NUMBER	12 VALUE
------	--------	--------	-------------	-----------------------------	------------------------	----------------------	-----------------------------------	----------

"Yes." I asked her if she knew they were officers. [REDACTED] said they were Sheriffs. She said they were all wearing uniforms.

[REDACTED] said she and her boyfriend stayed in the car for a short time and then decided to leave. She said they tried to leave but were detained by an officer. I asked [REDACTED] if she saw any of the officers or anyone inside the [REDACTED] shooting. She said, "no." I pointed to the [REDACTED] and asked her if that was the location where it came to rest and whether it had been moved. She said that was where it stopped and it was not moved after that point.

I asked [REDACTED] where the collision took place. She pointed to an area of asphalt near the entrance and said it was somewhere in that area. I asked [REDACTED] if she knew which of the patrol units had struck the [REDACTED]. She was not sure and said it might have been the unit that was now parked directly behind the [REDACTED]. [REDACTED] said the unit struck the [REDACTED] near the tire and it appeared as if the patrol unit was trying to stop the [REDACTED].

I asked her if the deputies had their guns drawn. She said the first deputy who arrived and stopped behind the [REDACTED] activated his emergency lights and spotlight in the [REDACTED]'s direction. She saw this deputy with his gun down at his side.

I asked [REDACTED] if the [REDACTED] was at the east end of the parking lot. She said the [REDACTED] was there before she and her boyfriend arrived. I asked her if it was also prior to the police unit arriving. She said, "Yes." [REDACTED] said the patrol unit arrived about five minutes later.

13 DATE / TIME OF REPORT 4/1/2003 / 10:45 AM	14 REPORTING OFFICER / ID NO / DIV / UNIT J. Rivera / 2696 / WC / Special Services	15 APPROVED BY / ID NO E. Montoya 1047
-------------------------------------------------	---------------------------------------------------------------------------------------	-------------------------------------------

NARRATIVE REPORT VENTURA COUNTY SHERIFF'S DEPARTMENT

Page 4 of 5

Continuation

AGENCY IDENTIFIER CA0560000

1 R.D. 3270	2 BEAT 3C2	3 RB NUMBER 03-8235
----------------	---------------	------------------------

4 CODE	5 ITEM	6 QTY.	7 ITEM NAME	8 BRAND / MAKE MANUFACTURER	9 MODEL NAME OR NUMBER	10 MISC. DESCRIPTION	11 IDENTIFICATION / SERIAL NUMBER	12 VALUE
--------	--------	--------	-------------	-----------------------------	------------------------	----------------------	-----------------------------------	----------

██████████ said the patrol unit came up to the ██████████. She said the ██████████ turned the engine on and began to back up without turning its lights on. She said the deputy was yelling something at the driver. ██████████ said the driver did not pay any attention to the deputy.

██████████ said the truck then traveled down (north/ west) the parking lot and appeared as though it was heading for the exit. She said that a second patrol unit was arriving and the two patrol units were able to surround the ██████████ at the north/ west end of the parking lot. I asked her if the ██████████ turned around and heading in the direction where it came to rest. She said, "Yes."

I asked ██████████ if she was able to see ██████████'s driver when it was parked at the top of the lot. She said she did not see the driver. ██████████ told me her boyfriend told her it was a female driver. She said that when she turned to look at the driver, the ██████████ was already traveling north/ west. I asked ██████████ if she saw the driver with a weapon. She said, "No."

I asked ██████████ if the ██████████ was traveling at a slow or fast speed. She said it was traveling at a slow speed. She mentioned that it also looked as if the driver of the ██████████ was trying to speed up but then changed his or her mind. ██████████ said it looked like the ██████████ was heading out of the parking lot onto Pacific Coast Highway. She said the ██████████ began to back up when the second patrol car was arriving. ██████████ said that was when the collision occurred. ██████████ said she was not sure which of the three patrol cars in the lot collided with the ██████████.

13 DATE / TIME OF REPORT 4/1/2003 / 10:45 AM	14 REPORTING OFFICER / ID NO / DIV / UNIT J. Rivera / 2696 / WC / Special Services	15 APPROVED BY / ID NO <i>E. Morstegh</i> 1047
-------------------------------------------------	---------------------------------------------------------------------------------------	---------------------------------------------------

NARRATIVE REPORT VENTURA COUNTY SHERIFF'S DEPARTMENT

Page 5 of 5

Continuation

AGENCY IDENTIFIER CA0560000

1 R.D.
3270

2 BEAT
3C2

3 RB NUMBER
03-8235

4 CODE	5 ITEM	6 QTY.	7 ITEM NAME	8 BRAND / MAKE MANUFACTURER	9 MODEL NAME OR NUMBER	10 MISC. DESCRIPTION	11 IDENTIFICATION / SERIAL NUMBER	12 VALUE
--------	--------	--------	-------------	-----------------------------	------------------------	----------------------	-----------------------------------	----------

I questioned [redacted] about the patrol car that arrived and first made contact with the [redacted] driver. [redacted] confirmed the patrol car arrived and activated its emergency lights and spotlight. She said the deputy exited the patrol car and had his gun drawn down along his side. [redacted] said the deputy was holding the gun in his right hand and at no time did she see him point it at the driver of the [redacted].

[redacted] said she heard the deputy say something to the driver, but she was not able hear what the deputy was saying. [redacted] said the [redacted] backed up and traveled north/ west. She said the deputy got back in his patrol car and followed the [redacted].

I asked [redacted] if this was the only patrol car she saw at this time. She said, "Yes." I asked her which side the [redacted] was parked and she said it was on the south side facing the ocean.

I did not have any further questions for [redacted] so I concluded my interview with her. No further details.

13 DATE / TIME OF REPORT 4/1/2003 / 10:45 AM	14 REPORTING OFFICER / ID NO / DIV / UNIT J. Rivera / 2696 / WC / Special Services	15 APPROVED BY / ID NO S. Montoya 1047
-------------------------------------------------	---------------------------------------------------------------------------------------	-------------------------------------------

NARRATIVE REPORT VENTURA COUNTY SHERIFF'S DEPARTMENT

Page 1 of 6 Continuation

AGENCY IDENTIFIER CA0560000

1 R.D. 3270	2 BEAT 3C2	3 RB NUMBER 03-8235
----------------	---------------	------------------------

4 CODE	5 ITEM	6 QTY.	7 ITEM NAME	8 BRAND / MAKE MANUFACTURER	9 MODEL NAME OR NUMBER	10 MISC. DESCRIPTION	11 IDENTIFICATION / SERIAL NUMBER	12 VALUE
--------	--------	--------	-------------	-----------------------------	------------------------	----------------------	-----------------------------------	----------

Supplemental Case Closed

Gang Domestic Hate Child Abuse Elderly Abuse

Connecting Report Numbers:

Code Section / Description: Officer Involved Shooting

Code: S Name: Pearlman, Nancy

Interview with

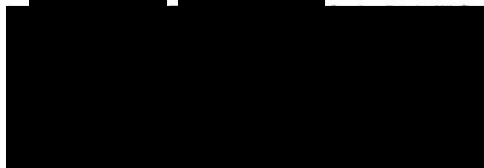

On 3-29-2003, I arranged to meet with [REDACTED] near her residence in order to show her a picture of the location where this incident occurred. I wanted her to outline the direction of travel that she had seen the [REDACTED] traveling in.

I arranged to meet [REDACTED] in the parking lot of the Center Point Mall in Oxnard. Her boyfriend, [REDACTED], accompanied [REDACTED]. [REDACTED] was also at the scene when this incident occurred and was interviewed by another detective.

I asked both if they could sit in my car while I showed them a photograph. Both agreed and sat in my car. My conversation with them was tape-recorded and the following is a synopsis.

13 DATE / TIME OF REPORT 4/1/2003 / 4:36 PM	14 REPORTING OFFICER / ID NO / DIV / UNIT J. Rivera / 2696 / WC / Special Services	15 APPROVED BY / ID NO E. Montoya / 1017
------------------------------------------------	---------------------------------------------------------------------------------------	---------------------------------------------

NARRATIVE REPORT VENTURA COUNTY SHERIFF'S DEPARTMENT

Page 2 of 6

Continuation

AGENCY IDENTIFIER CA0560000

1 R.D.
3270

2 BEAT
3C2

3 RB NUMBER
03-8235

4 CODE	5 ITEM	6 QTY.	7 ITEM NAME	8 BRAND / MAKE MANUFACTURER	9 MODEL NAME OR NUMBER	10 MISC. DESCRIPTION	11 IDENTIFICATION / SERIAL NUMBER	12 VALUE
--------	--------	--------	-------------	-----------------------------	------------------------	----------------------	-----------------------------------	----------

I showed [redacted] and [redacted] three photographs. One of the photos was an aerial view that pictured the entire parking lot. The second was a close up view of the top portion of the parking lot and the third showed a series of photographs depicting the suspect's [redacted]. I showed [redacted] and [redacted] the second photograph and drew in black marker where they were parked and the direction they were facing. In red marker I drew in the location where they identified the [redacted] as being parked and the direction it was facing. I also drew in black ink the location where they saw the police car parked and facing.

They placed the [redacted] as being parked south from them about 4 or 5 parking spaces away. [redacted] and [redacted] said the police car parked behind the [redacted] and was facing south. [redacted] said he noticed the police officer shining his lights at all of the cars as he drove in the parking lot. [redacted] and [redacted] said the officer then placed the spotlight on the [redacted]. I asked [redacted] if the officer had his emergency lights on. He said, "not yet."

[redacted] said he turned away for a short time and then turned back in the direction of the police car and the [redacted]. [redacted] said he saw the police officer out of the car and heard him telling the occupant of the [redacted] to get out of the car. [redacted] said the officer was holding a flashlight in his left hand. [redacted] and [redacted] said they did not hear a response from the occupant in the [redacted].

I asked [redacted] if he was able to see inside the [redacted]. He said after the officer shined his light in the [redacted] he could see that it was a female. [redacted] said she

13 DATE / TIME OF REPORT 4/1/2003 / 4:36 PM	14 REPORTING OFFICER / ID NO / DIV / UNIT J. Rivera / 2696 / WC / Special Services	15 APPROVED BY / ID NO <i>E. Montoya</i> 1047
------------------------------------------------	---------------------------------------------------------------------------------------	--------------------------------------------------

NARRATIVE REPORT VENTURA COUNTY SHERIFF'S DEPARTMENT

Page 3 of 6

Continuation

AGENCY IDENTIFIER CA0560000

1 R.D. 3270	2 BEAT 3C2	3 RB NUMBER 03-8235
----------------	---------------	------------------------

4 CODE	5 ITEM	6 QTY.	7 ITEM NAME	8 BRAND / MAKE MANUFACTURER	9 MODEL NAME OR NUMBER	10 MISC. DESCRIPTION	11 IDENTIFICATION / SERIAL NUMBER	12 VALUE
--------	--------	--------	-------------	-----------------------------	------------------------	----------------------	-----------------------------------	----------

did not see the female because the officer had turned his light away from the [redacted]'s occupant when [redacted] turned to look.

[redacted] said he heard the officer tell the occupant again to get out of the car, but did not see the occupant get out. He then heard the sound of a car's engine come on and saw the [redacted] backing up. [redacted] said he saw the officer pull his gun out and tell the driver to stop and get out of the car. He saw the officer take cover behind the police car as the [redacted] was backing up.

I asked [redacted] when she saw the officer with his gun out. She said that she turned around at one point and saw the officer with his gun drawn. She said the officer had his gun in his right hand pointing down along his right leg. I asked [redacted] where she saw the officer standing. She pointed to a location in photograph number two placing the officer between the back of the [redacted] and the right front corner of his police car.

[redacted] said he also saw the officer with the gun along the side of his right leg. He said he saw the officer raise and point his gun at the driver of the [redacted] after it started to back up.

[redacted] said the [redacted] then proceeded to travel north along the right side of the police car. He said the officer got back in his car and activated his emergency lights. He saw the police car make a right-handed U-turn and follow the [redacted]. [redacted] said the [redacted] was not going to fast, but was not stopping. [redacted] and [redacted] said there were instances that the driver of the [redacted] accelerated and then stopped without warning.

13 DATE / TIME OF REPORT 4/1/2003 / 4:36 PM	14 REPORTING OFFICER / ID NO / DIV / UNIT J. Rivera / 2696 / WC / Special Services	15 APPROVED BY / ID NO <i>E. Montoya</i> 1047
------------------------------------------------	---------------------------------------------------------------------------------------	--------------------------------------------------

NARRATIVE REPORT VENTURA COUNTY SHERIFF'S DEPARTMENT

Page 4 of 6

Continuation

AGENCY IDENTIFIER CA0560000

1 R.D. 3270	2 BEAT 3C2	3 RB NUMBER 03-8235
----------------	---------------	------------------------

4 CODE	5 ITEM	6 QTY.	7 ITEM NAME	8 BRAND / MAKE MANUFACTURER	9 MODEL NAME OR NUMBER	10 MISC. DESCRIPTION	11 IDENTIFICATION / SERIAL NUMBER	12 VALUE
--------	--------	--------	-------------	-----------------------------	------------------------	----------------------	-----------------------------------	----------

I marked the [redacted]'s path of travel with a red marker. I marked the police car's path of travel with a black marker. I also marked both vehicles' paths of travel on photograph number one.

[redacted] said the [redacted] continued to travel north/ west down the parking lot towards the exit. He said the police car followed behind the [redacted]. He said at some point the police car collided with the left side of the [redacted]. He said the area was just past the asphalt area near the entrance. I marked this location with a red circle on photograph number one.

[redacted] said that about this time he saw a second patrol car arriving in the parking lot. He said the second police car was traveling south on Pacific Coast Highway as it reached the entrance to the parking lot. [redacted] said she also saw the second police car arrive from the same direction. The second police car's path is marked on photograph number one in black marker.

[redacted] said he then saw the officer in the first car get out of his car with his gun in his hand. He said he could not make out what the officers were telling the driver of the [redacted] because they were a long distance away. [redacted] said the second police car parked next to the first police car. [redacted] said the officer in the second car got out of his car and pointed his gun in the direction of the [redacted].

[redacted] said that she thinks the driver of the [redacted] made a right-handed U-turn (marked in blue ink). [redacted] told me it was a left-handed U-turn and not to the

13 DATE / TIME OF REPORT 4/1/2003 / 4:36 PM	14 REPORTING OFFICER / ID NO / DIV / UNIT J. Rivera / 2696 / WC / Special Services	15 APPROVED BY / ID NO <i>E. Montoya</i> 1047
------------------------------------------------	---------------------------------------------------------------------------------------	--------------------------------------------------

NARRATIVE REPORT VENTURA COUNTY SHERIFF'S DEPARTMENT

Page 5 of 6

Continuation

AGENCY IDENTIFIER CA0560000

1 R.D. 3270	2 BEAT 3C2	3 RB NUMBER 03-8235
----------------	---------------	------------------------

4 CODE	5 ITEM	6 QTY.	7 ITEM NAME	8 BRAND / MAKE MANUFACTURER	9 MODEL NAME OR NUMBER	10 MISC. DESCRIPTION	11 IDENTIFICATION / SERIAL NUMBER	12 VALUE
--------	--------	--------	-------------	-----------------------------	------------------------	----------------------	-----------------------------------	----------

right. [redacted] said that as the [redacted] made the U-turn, the police car struck the [redacted] again. [redacted] said he did not see the second collision.

[redacted] said she heard about 3, 4, or 5 gunshots. She figured that those were aimed at the tires because they went flat. [redacted] said the [redacted]'s tires were flat as it continued making the U-turn. She then heard several more shot fired after that. [redacted] and [redacted] said the [redacted] came to rest along the small berm next to the exit.

I asked [redacted] and [redacted] if they heard the officer say anything to the driver after the shots were fired. [redacted] said they did not hear anything except for the gunshots because they were so far away. I asked them if they knew which of the officer had fired their guns. [redacted] shook her head "no" and [redacted] said they were too far away to see that.

I asked [redacted] what the officer looked like. He said the officer was Caucasian, but that was all he could describe. I asked him if the officer was wearing a uniform. He said the officer was wearing a green uniform and said both officers were Sheriffs. I asked [redacted] if the police cars were marked cars and not plain like mine. [redacted] said both were both marked Sheriff's cars. I asked [redacted] the same thing and she also confirmed they were marked Sheriff's cars.

I asked about the lighting conditions. [redacted] and [redacted] both said it was dark and that one would need a flashlight. They also said that from their location they could clearly see the officer and that he was a Sheriff. I asked them if they heard the occupant of the [redacted] say anything to the officer. They both said, "No."

13 DATE / TIME OF REPORT 4/1/2003 / 4:36 PM	14 REPORTING OFFICER / ID NO / DIV / UNIT L. Rivera / 2696 / WC / Special Services	15 APPROVED BY / ID NO <i>E. Martinez</i> 1047
------------------------------------------------	---------------------------------------------------------------------------------------	---------------------------------------------------

NARRATIVE REPORT VENTURA COUNTY SHERIFF'S DEPARTMENT

Page 6 of 6

Continuation

AGENCY IDENTIFIER CA0560000

1 R.D. 3270	2 BEAT 3C2	3 RB NUMBER 03-8235
----------------	---------------	------------------------

4 CODE	5 ITEM	6 QTY.	7 ITEM NAME	8 BRAND / MAKE MANUFACTURER	9 MODEL NAME OR NUMBER	10 MISC. DESCRIPTION	11 IDENTIFICATION / SERIAL NUMBER	12 VALUE
--------	--------	--------	-------------	-----------------------------	------------------------	----------------------	-----------------------------------	----------

██████████ said he did see the female moving her head around in a nervous manner when the officer illuminated her with his flashlight.

I asked ██████████ and ██████████ if they saw the ██████████'s occupant holding any weapons in her hand. They both said, "No."

I asked ██████████ and ██████████ if there was anything else that they felt was important. ██████████ said that after the ██████████ made the U-turn it came very close to the officer in the second car. He said it was so close that it may have struck the car. He said he did not know how close the ██████████ came to the officer or where the officer was at the time.

██████████ said the officer did approach the ██████████ after it came to rest. He said the officer had their guns drawn and pointed at the ██████████. After that point they did not look over anymore.

I did not have any further questions for ██████████ or ██████████ so I concluded my interview with them. No further details.

During my interview with ██████████ and ██████████, I showed them photograph number three and asked them if that was the vehicle they had seen the police stop and then follow. Both agreed it was the same vehicle.

13 DATE / TIME OF REPORT 4/1/2003 / 4:36 PM	14 REPORTING OFFICER / ID NO / DIV / UNIT J. Rivera / 2696 / WC / Special Services	15 APPROVED BY / ID NO <i>E. Montoya</i> 1047
------------------------------------------------	---------------------------------------------------------------------------------------	--------------------------------------------------

NARRATIVE REPORT VENTURA COUNTY SHERIFF'S DEPARTMENT

Page 1 of 3 Continuation

AGENCY IDENTIFIER CA0560000

1 R.D. 3267	2 BEAT 3C02	3 RB NUMBER 03-008235
----------------	----------------	--------------------------

4 CODE	5 ITEM	6 QTY.	7 ITEM NAME	8 BRAND / MAKE MANUFACTURER	9 MODEL NAME OR NUMBER	10 MISC. DESCRIPTION	11 IDENTIFICATION / SERIAL NUMBER	12 VALUE
--------	--------	--------	-------------	-----------------------------	------------------------	----------------------	-----------------------------------	----------

- Supplemental Case Cleared
- Gang Domestic Hate Child Abuse Elderly Abuse

Connecting Report Numbers:

Code Section / Description: Officer Involved Shooting

Reclassify To:

Code: **Name:**

Witness Interview 03/20/03

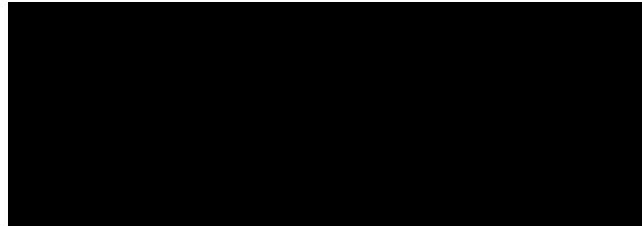

On 03/20/03, I was in the north public parking area of Mugu Rock assisting with the investigation of a shooting involving two on-duty Ventura County Sheriff's Deputies. At about 2109 hours, I interviewed [REDACTED], who was a witness to the incident, on the west side of the north parking lot of Mugu Rock, just south of the entrance to the lot. The interview was tape-recorded.

[REDACTED], in summary, told me the following. On 03/20/03, at about 1915 hours, he and his girlfriend, [REDACTED], parked in the north parking lot of Mugu Rock at the top of the hill, which was approximately 300 feet south of the entrance to the parking lot. He said they were sitting in [REDACTED]'s white [REDACTED] and were eating food and talking with each other.

About 5 or 10 minutes after they parked, [REDACTED] saw a sheriff's patrol car drive into the parking lot and shine its spotlights on a [REDACTED] [REDACTED]. [REDACTED] noticed the [REDACTED] parked about 50 feet south of his vehicle when they arrived at the parking lot. He said the [REDACTED] was facing west, toward the ocean, and he did not notice anything out of the ordinary about it.

13 DATE / TIME OF REPORT
03/25/03/ 8:32 AM

14 REPORTING OFFICER / ID NO / DIV / UNIT
Sgt. W. Ayub/#3318/Special Services

15 APPROVED BY / ID NO
E. Montoya 1047

NARRATIVE REPORT VENTURA COUNTY SHERIFF'S DEPARTMENT

Page 2 of 3 Continuation

AGENCY IDENTIFIER CA0560000

1 R.D. 3267	2 BEAT 3C02	3 RB NUMBER 03-008235
----------------	----------------	--------------------------

4 CODE	5 ITEM	6 QTY.	7 ITEM NAME	8 BRAND / MAKE MANUFACTURER	9 MODEL NAME OR NUMBER	10 MISC. DESCRIPTION	11 IDENTIFICATION / SERIAL NUMBER	12 VALUE
--------	--------	--------	-------------	-----------------------------	------------------------	----------------------	-----------------------------------	----------

██████████ said he watched as the deputy got out of his car and yelled at the occupant(s) of the ██████████ to step out of their vehicle. ██████████ said the windows of his vehicle were rolled up and the stereo was on but he could clearly hear the deputy's commands. He heard the deputy yell again, "Get out of the car". After the second command, the deputy refocused the patrol car's spotlight on the driver and ██████████ could then see the silhouette of a thin female with short hair sitting in the driver's seat. The driver appeared to be the only occupant of the ██████████. ██████████ could not describe the occupant further and he could not describe the deputy. He knew it was a deputy sheriff because he could see the deputy's uniform.

When the deputy illuminated the driver of the ██████████, ██████████ noticed that she appeared to be very nervous. ██████████ opened his eyes wide and he turned his head from side to side as a demonstration of the way the driver was acting when the light was shined on her. ██████████ heard the ██████████'s engine start and the deputy yelled a third time to "get out of the car". ██████████ also noticed that the deputy had drawn his pistol and was holding down by his side. He never saw the deputy point the pistol at the ██████████.

██████████ continued watching the incident and he saw the ██████████ back out of its parking spot and start driving off northbound through the parking lot with no headlights on. The deputy got back into his patrol car, turned the "lights" on, and followed the ██████████. ██████████ saw the ██████████ erratically speeding up and slowing down as the deputy followed it. He said it appeared as if the driver of the ██████████ was "mocking" the deputy. ██████████ watched the ██████████ as it drove past the entrance to the parking lot. Just as the ██████████ passed the entrance, ██████████ saw the sheriff's patrol car "ram" the ██████████. ██████████ motioned with hands to simulate the positions of the two vehicles and he indicated that the patrol car hit the ██████████'s left rear quarter panel, at about a 45-degree angle, with its right front bumper. ██████████ said the ██████████'s rear end slid sideways slightly and both vehicles came to a stop just after the impact.

Another patrol car arrived just after the first patrol car rammed the ██████████. The second patrol car pulled in behind the first patrol car, which was still behind the ██████████. ██████████ could see that both

13 DATE / TIME OF REPORT 03/25/03/ 8:32 AM	14 REPORTING OFFICER / ID NO / DIV / UNIT Sgt. W. Ayub/#3318/Special Services	15 APPROVED BY / ID NO <i>E. Montoya</i> 1047
-----------------------------------------------	----------------------------------------------------------------------------------	--------------------------------------------------

NARRATIVE REPORT VENTURA COUNTY SHERIFF'S DEPARTMENT

Page 3 of 3

Continuation

AGENCY IDENTIFIER CA0560000

1 R.D. 3267	2 BEAT 3C02	3 RB NUMBER 03-008235
----------------	----------------	--------------------------

4 CODE	5 ITEM	6 QTY.	7 ITEM NAME	8 BRAND / MAKE MANUFACTURER	9 MODEL NAME OR NUMBER	10 MISC. DESCRIPTION	11 IDENTIFICATION / SERIAL NUMBER	12 VALUE
--------	--------	--------	-------------	-----------------------------	------------------------	----------------------	-----------------------------------	----------

deputies were out of their vehicles but he could not see what they were doing and he could not hear what, if anything, was being said. [REDACTED] said both patrol cars had their emergency lights flashing while they were stopped behind the [REDACTED].

[REDACTED] said he turned away briefly and when he turned back he saw the [REDACTED] make a left U-turn and drive past the deputies' patrol cars. Just as the [REDACTED] passed the second patrol car, [REDACTED] heard approximately 5 shots. He heard two shots, a pause, and then about 3 more shots. [REDACTED] said the [REDACTED] continued driving slowly southbound through the parking lot and came to a stop just south of the entrance to the parking lot. He pointed to the [REDACTED] which was stopped facing south against the east berm of the parking lot, about 30 feet south of the entrance to the parking lot. [REDACTED] said the [REDACTED] is stopped in the same spot where he saw it stop after the shots were fired. Almost immediately after the shooting, a third sheriff's patrol car arrived, followed by an ambulance.

I asked [REDACTED] if he was certain that the [REDACTED] passed both of the patrol cars before he heard the shots. He thought briefly and said that he was pretty certain the [REDACTED] had passed both patrol cars but he conceded that it was very dark and, based on his description of where he was parked, he was about 125 yards from the shooting. [REDACTED] also said he could not see what the driver of the [REDACTED] was doing at the time the shots were fired. He said the [REDACTED] did not appear to be driving particularly fast, maybe 10 mph, but it did drive very close to the second patrol car. [REDACTED] could not tell if the deputies had to jump out of the way of the [REDACTED] to avoid being struck by it.

I concluded the interview with [REDACTED] and advised him that he may be contacted if some additional questions concerning this incident arise.

End of interview.

13 DATE / TIME OF REPORT 03/25/03/ 8:32 AM	14 REPORTING OFFICER / ID NO / DIV / UNIT Sgt. W. Ayub/#3318/Special Services	15 APPROVED BY / ID NO <i>E. Norstgen</i> 1047
-----------------------------------------------	----------------------------------------------------------------------------------	---------------------------------------------------

**ADDITIONAL NAMES
REPORT**

VENTURA COUNTY SHERIFF'S DEPARTMENT

AGENCY IDENTIFIER CA0560000

Page 1 of 1

1 RB NUMBER
03-8735

24 COMMENTS:

CODE 26 NAME (Last, First, Middle, Gen.) / FIRM NAME AKA / Moniker RACE 50 SEX 51 28 HT 29 WT 31 HAIR 33 EYES 35 DOB 37 AGE

48 49 NAME (Last, First, Middle, Gen.) / FIRM NAME AKA / Moniker RACE 50 SEX 51 52 HT 53 WT 54 HAIR 55 EYES 56 DOB 57 AGE

58 RESIDENCE ADDRESS / (Same as Box # _____) CITY STATE ZIP 59 RESIDENCE PHONE ()

60 BUSINESS / SCHOOL NAME ADDRESS / (Same as Box # _____) CITY STATE ZIP 61 BUSINESS PHONE ()

62 OCCUPATION (STUDENT) 63 DAYS OFF 64 WORK HRS. 65 INTERPRETER 66 OPERATOR'S LIC. NO. / STATE

67 VEH. LIC. NO. / STATE 68 VEH. COLOR / YEAR / MAKE / MODEL / BODY STYLE 69 OTHER CHARACTERISTICS / VIN NO.

70 COMMENTS:

71 CODE 72 NAME (Last, First, Middle, Gen.) / FIRM NAME AKA / Moniker RACE 73 SEX 74 75 HT 76 WT 77 HAIR 78 EYES 79 DOB 80 AGE

81 RESIDENCE ADDRESS / (Same as Box # _____) CITY STATE ZIP 82 RESIDENCE PHONE ()

83 BUSINESS / SCHOOL NAME ADDRESS / (Same as Box # _____) CITY STATE ZIP 84 BUSINESS PHONE ()

85 OCCUPATION (STUDENT) 86 DAYS OFF 87 WORK HRS. 88 INTERPRETER 89 OPERATOR'S LIC. NO. / STATE

90 VEH. LIC. NO. / STATE 91 VEH. COLOR / YEAR / MAKE / MODEL / BODY STYLE 92 OTHER CHARACTERISTICS / VIN NO.

93 COMMENTS:

94 DATE / TIME OF REPORT 3/21/03 0350 95 REPORTING OFFICER / ID NO. / DIV. / UNIT MULROONEY / 3283 / WCPS / CAM 96 APPROVED BY / ID NO. A. Agui / 12486

NARRATIVE REPORT VENTURA COUNTY SHERIFF'S DEPARTMENT

Page 1 of 4 Continuation

AGENCY IDENTIFIER CA0560000

1 R.D. 3262	2 BEAT 3CDL	3 RB NUMBER 2003-8235
----------------	----------------	--------------------------

4 CODE	5 ITEM	6 QTY.	7 ITEM NAME	8 BRAND / MAKE MANUFACTURER	9 MODEL NAME OR NUMBER	10 MISC. DESCRIPTION	11 IDENTIFICATION / SERIAL NUMBER	12 VALUE
--------	--------	--------	-------------	-----------------------------	------------------------	----------------------	-----------------------------------	----------

On 3/20/2003, at 1900 hours, I was in briefing. Deputy Fast (#3220) advised of an Attempt To Locate (ATL) a possible suicidal subject, identified as Nancy Pearlman, driving [REDACTED] Pearlman was last seen leaving [REDACTED] in the city of Camarillo armed with a Smith and Wesson 9mm handgun.

At 1912 hours, Deputy Gutierrez entered the briefing room and said, "3C51 (Sr. Deputy Stevens) is in pursuit of the suicidal lady from [REDACTED] by Mugu Rock." Sergeant Hanley told Fast and I to respond to assist.

At 1917 hours, I advised dispatch that I was responding to assist 3C51. I told dispatch I was responding "Code-3"- lights and siren. While I was driving to the last known location of the pursuit, south of Mugu Rock, I heard the units on scene advising Pearlman was not responding to direction and was attempting to drive away. Moments later, I heard on the radio that the suspect had a head wound. Fire and Ambulance were requested.

At about 1927 hours, I arrived on scene. I saw Pearlman's SUV stopped just inside the entrance to Mugu State Beach, which has a parking lot with only one entrance/exit. The rest of the parking lot is separated from the Pacific Coast Highway with a fence. It is bordered to the north by the Point Mugu Firing range, to the south by Mugu Rock, to the west by the ocean, and to the east by PCH (State Highway 1) and a mountain range.

I saw a Fire truck parked on PCH at the entrance to Mugu State Beach. I saw Sr. Deputy Schierman (#2347) blocking the entrance and he told me to check the south side of Mugu Rock for potential witnesses. I started at the entrance of Mugu State Beach and continued south on PCH for 1 mile. I did not locate any persons parked on the side of the road.

I returned to the scene. I parked my police car blocking the northbound left turn pocket at Mugu State Beach. I told Schierman I did not locate anyone south of the incident for 1 mile. He instructed me to contact potential witnesses parked in the Mugu State Beach parking lot south of the incident in a [REDACTED] pick-up truck with a camper shell.

13 DATE / TIME OF REPORT 3/23/03 0530	14 REPORTING OFFICER / ID NO / DIV / UNIT MULROONEY / 3283 / WCPS / CAM	15 APPROVED BY / ID NO A. [Signature] / 2486
------------------------------------------	----------------------------------------------------------------------------	-------------------------------------------------

NARRATIVE REPORT VENTURA COUNTY SHERIFF'S DEPARTMENT

Page 2 of 4 Continuation

AGENCY IDENTIFIER CA0560000

1 R.D. 3262	2 BEAT 3002	3 RB NUMBER 2003-8235
----------------	----------------	--------------------------

4 CODE	5 ITEM	6 QTY.	7 ITEM NAME	8 BRAND / MAKE MANUFACTURER	9 MODEL NAME OR NUMBER	10 MISC. DESCRIPTION	11 IDENTIFICATION / SERIAL NUMBER	12 VALUE
--------	--------	--------	-------------	-----------------------------	------------------------	----------------------	-----------------------------------	----------

I went to the truck, a [REDACTED]
 I contacted the occupants, a Hispanic female, later identified as (W-1) [REDACTED]
 [REDACTED] and a Hispanic male, later identified as (W-2) [REDACTED].
 [REDACTED] told me [REDACTED] only speaks Spanish.

WITNESS STATEMENTS:

(W-1) [REDACTED]

In summary, [REDACTED] told me she was sitting on the tailgate of the truck, when she saw a police car, traveling north on PCH, with the overhead lights on. She saw a SUV pull into the parking lot followed by the police car. A couple of minutes later she saw a second police car pull into the parking lot.

She and [REDACTED] needed to use the restroom, so they began to walk from the truck to the bathroom. I noticed her truck was parked facing the roadway (PCH) and was about 200 feet south of the bathroom facilities (port-a-potty toilets). I noticed Pearlman's SUV was parked in the parking lot across from the toilets, about 50 feet away. I noticed 2 lifeguard towers, #14 and #15 on the beach between [REDACTED]'s truck and the bathroom.

[REDACTED] showed me where she and [REDACTED] walked. She was about half way to the bathroom, almost even with Lifeguard tower 14, when she heard a bang that sounded, to her, like gunfire. She looked at [REDACTED] and they both fell to the ground over a slight embankment toward the beach. They landed in the bushes. She said she heard a total of 5 gunshots. She believes a total time of 4 minutes passed from the first shot to the last shot. She said she never saw who shot a gun, or any other part of the incident from the first gunshot to the end of the incident.

[REDACTED] told me she was not injured. She said she did not need to talk to a counselor or Chaplain. She wanted to know when she could leave the scene. I advised her detectives would want to talk to her before she left the area.

13 DATE / TIME OF REPORT 3/23/03 0530	14 REPORTING OFFICER / ID NO / DIV / UNIT MULLROONEY / 3283 / WCPS / CAM	15 APPROVED BY / ID NO [Signature] / 2486
------------------------------------------	-----------------------------------------------------------------------------	----------------------------------------------

NARRATIVE REPORT VENTURA COUNTY SHERIFF'S DEPARTMENT

Page 3 of 4 Continuation

AGENCY IDENTIFIER CA0560000

1 R.D. 3262	2 BEAT 3002	3 RB NUMBER 2003-8235
----------------	----------------	--------------------------

4 CODE	5 ITEM	6 QTY.	7 ITEM NAME	8 BRAND / MAKE MANUFACTURER	9 MODEL NAME OR NUMBER	10 MISC. DESCRIPTION	11 IDENTIFICATION / SERIAL NUMBER	12 VALUE
--------	--------	--------	-------------	-----------------------------	------------------------	----------------------	-----------------------------------	----------

(W-2) [REDACTED]

I asked [REDACTED] if she would translate, so I could obtain a statement from [REDACTED]. She agreed. I told her I needed her to repeat my questions to [REDACTED] without interpretation and tell me exactly what his answers were. She agreed.

[REDACTED] told me he was with [REDACTED] on the back of the truck. They saw a police car go by. A few minutes later they started walking toward the bathroom. He noticed the police car had pulled over a car and he saw a second police car pull into the parking lot. Within a minute, [REDACTED] heard a gun shot. He and [REDACTED] dropped to the ground into the bushes to their left.

[REDACTED] said he heard a total of 3 shots. He estimated the time from first shot to the last shot to be 4 minutes. He said he never saw where the shot came from or what occurred. [REDACTED] thought the shot came from the area where the police were located.

[REDACTED] showed me where he was standing at the time of the first shot. He showed me where he dove. [REDACTED] showed me the same place [REDACTED] had shown me.

13 DATE / TIME OF REPORT 3/23/03 0530	14 REPORTING OFFICER / ID NO / DIV / UNIT MULROONEY / 3283 / WCPS / CAM	15 APPROVED BY / ID NO [Signature] / 2486
------------------------------------------	----------------------------------------------------------------------------	----------------------------------------------

NARRATIVE REPORT VENTURA COUNTY SHERIFF'S DEPARTMENT

Page 4 of 4

Continuation

AGENCY IDENTIFIER CA0560000

1 R.D. 3262	2 BEAT 3002	3 RB NUMBER 2003-8235
----------------	----------------	--------------------------

4 CODE	5 ITEM	6 QTY.	7 ITEM NAME	8 BRAND / MAKE MANUFACTURER	9 MODEL NAME OR NUMBER	10 MISC. DESCRIPTION	11 IDENTIFICATION / SERIAL NUMBER	12 VALUE
--------	--------	--------	-------------	-----------------------------	------------------------	----------------------	-----------------------------------	----------

After interviewing [redacted] and [redacted], I contacted Sergeant Hanley, the Incident Commander. He asked me to start an incident log listing all personnel at the scene and their time of arrival and departure. I contacted dispatch to get arrival times for personnel already on scene. I started the incident log and maintained the log until the completion of the incident. Refer to attached Incident log for details. Some times were estimated and denoted with Est. before the time on the log.

Deputy Fast maintained the Crime Scene log for all personnel entering the crime scene. Refer to Deputy Fast's report for details.

All units involved in the incident were advised to complete supplemental reports.

At 0315 hours, Pearlman's body was removed from the scene by CMA technicians Frank [redacted] and John [redacted]. They transported the body to the Coroner's office.

At about 0330 hours, Sergeant Montagna told me to have Pearlman's vehicle towed to the Ventura County Crime Lab. Montagna advised me Pearlman had brandished a firearm at Stephens and Cerio resulting in Stephen's responding with deadly force. A crime report was taken for 417 (C) PC-brandishing a firearm at a police officer.

At 0405 hours, Pearlman's vehicle was towed by Owl Towing of Oxnard to the Ventura County Crime Lab as evidence per 22655.5 VC.

At 0445 hours, the processing of the scene was completed and cleared.

13 DATE / TIME OF REPORT 3/23/03 0530	14 REPORTING OFFICER / ID NO / DIV / UNIT MULRONEY / 3283 / WCPS / CAM	15 APPROVED BY / ID NO A. [Signature] / 2486
------------------------------------------	---------------------------------------------------------------------------	-------------------------------------------------

NARRATIVE REPORT VENTURA COUNTY SHERIFF'S DEPARTMENT

Page 1 of 2 Continuation

AGENCY IDENTIFIER CA0560000

1 R.D. 3362	2 BEAT 302	3 RB NUMBER 1005-9235
----------------	---------------	--------------------------

4 CODE	5 ITEM	6 QTY.	7 ITEM NAME	8 BRAND / MAKE MANUFACTURER	9 MODEL NAME OR NUMBER	10 MISC. DESCRIPTION	11 IDENTIFICATION / SERIAL NUMBER	12 VALUE
--------	--------	--------	-------------	-----------------------------	------------------------	----------------------	-----------------------------------	----------

Supplemental Case Cleared

Gang Domestic Hate Child Abuse Elderly Abuse

Connecting Report Numbers:

Code Section / Description: OFFICER INVOLVED SHOOTING

Code: S Name: Perlman, Nancy

On 03-20-03, Sr. Deputy Heersche#1312 and I were working uniformed patrol in the city of Oxnard. We were assigned to the Crime Suppression Unit. At approximately 1915 hours, we responded to the area of PCH and Mugu Rock to assist two Sheriff's Department deputies(3C51) and (3D51) with a suicidal subject. While we were en route to the call, we heard dispatch advise that shots were fired.

We arrived at approximately 1923 hours, and saw a [REDACTED] vehicle [REDACTED] [REDACTED] stopped near the entrance to Mugu State Park beach. I saw Deputy Cerio standing on the driver side of the [REDACTED] with the driver's door open. I saw Sr. Deputy Stevens standing on the passenger side of the [REDACTED] with the passenger door open. I parked our patrol unit directly behind the [REDACTED]. I exited our vehicle and approached Sr. Deputy Stevens. I heard Stevens say, "She's 10-7". I looked inside the [REDACTED] through the passenger side and saw a female sitting in the driver seat with blood on her face. The female appeared to be unconscious and not breathing. I then heard Sr. Deputy Stevens tell Sr. Deputy Heersche that he had shot the female. Heersche instructed me to start setting up a crime scene and attempt to locate any possible witness.

I saw the following vehicles that were still parked in the parking lot of Mugu State Park beach:

[REDACTED]

There was a fourth vehicle that was parked at the far south end of the parking lot that Deputy Joe Mulrooney contacted.

13 DATE / TIME OF REPORT 3-24-03 / 1300	14 REPORTING OFFICER / ID NO / DIV / UNIT MCCONVILLE / 3910 / CSU	15 APPROVED BY / ID NO A. [Signature] / 2486
--------------------------------------------	----------------------------------------------------------------------	-------------------------------------------------

NARRATIVE REPORT VENTURA COUNTY SHERIFF'S DEPARTMENT

Page 2 of 4 Continuation

AGENCY IDENTIFIER CA0560000

1 R.D. 3062	2 BEAT 300	3 RB NUMBER 2003-8134
----------------	---------------	--------------------------

4 CODE	5 ITEM	6 QTY.	7 ITEM NAME	8 BRAND / MAKE MANUFACTURER	9 MODEL NAME OR NUMBER	10 MISC. DESCRIPTION	11 IDENTIFICATION / SERIAL NUMBER	12 VALUE
--------	--------	--------	-------------	-----------------------------	------------------------	----------------------	-----------------------------------	----------

INTERVIEW WITH [REDACTED]:

I contacted [REDACTED] who was alone in her vehicle. [REDACTED] did not speak any English. I told [REDACTED] to stay in her car and wait until a Spanish-speaking detective arrived to interview her.

INTERVIEW WITH [REDACTED]:

I contacted [REDACTED] who was alone in his vehicle. [REDACTED] did not speak very good English. I told [REDACTED] to stay in his car until a Spanish-speaking detective arrived to interview him.

INTERVIEW WITH [REDACTED]:

I contacted [REDACTED] who was sitting in the driver's seat of his vehicle. [REDACTED]'s girlfriend ([REDACTED]) was sitting in the passenger seat. [REDACTED] told me the following: [REDACTED] and his girlfriend drove into the Mugu State Beach parking lot at approximately 1900 hours. [REDACTED] saw a [REDACTED] parked at the south end of the parking lot. [REDACTED] parked his car approximately five-car spaces north of the [REDACTED]. [REDACTED] was unable to determine if anyone was inside the [REDACTED] because it was too dark. [REDACTED] said there were also approximately three other cars in the parking lot.

[REDACTED] was talking with his girlfriend inside the car for approximately 5-10 minutes after he parked his car. [REDACTED] saw a Sheriff's department patrol unit park behind the [REDACTED] and shine the spot light into the car. [REDACTED] heard the deputy tell the occupant of the [REDACTED] to exit the vehicle. The occupant of the [REDACTED] did not respond. [REDACTED] saw the [REDACTED] start to back up and drive away toward the entrance of the parking lot. [REDACTED] said the [REDACTED] would accelerate fast and then slam on its brakes. The [REDACTED] did not have the lights on when it was driving.

[REDACTED] said the Deputy started following the [REDACTED] in his patrol car. The patrol car had its lights and sirens on when it was following the [REDACTED]. When the [REDACTED] got near the entrance of the parking lot, the patrol car rammed the [REDACTED] near the back quarter panel of the driver's side. The [REDACTED] spun around and was facing toward the ocean. The deputy got out of his patrol car and yelled an unknown command at the driver. A second Sheriff's Department patrol unit arrived and parked next to the first patrol unit. [REDACTED] saw the [REDACTED] start to drive away. [REDACTED] said the [REDACTED] looked like it was driving toward the second deputy. [REDACTED] heard gunshots, and then saw the [REDACTED] crash into the embankment

13 DATE / TIME OF REPORT

3-27-03 / 300

14 REPORTING OFFICER / ID NO / DIV / UNIT

McDougle / 300 / 230

15 APPROVED BY / ID NO

A. [Signature] / 2486

NARRATIVE REPORT VENTURA COUNTY SHERIFF'S DEPARTMENT

Page 3 of 4 ~~Continuation~~

AGENCY IDENTIFIER CA0560000

1 R.D. 3232	2 BEAT 322	3 RB NUMBER 0053-3235
----------------	---------------	--------------------------

4 CODE	5 ITEM	6 QTY.	7 ITEM NAME	8 BRAND / MAKE MANUFACTURER	9 MODEL NAME OR NUMBER	10 MISC. DESCRIPTION	11 IDENTIFICATION / SERIAL NUMBER	12 VALUE
--------	--------	--------	-------------	-----------------------------	------------------------	----------------------	-----------------------------------	----------

near the entrance. ██████ told me he only heard the shots being fired and did not see who fired the shots. ██████ said he never saw who was driving the ██████. ██████ saw the two deputies run up to the ██████ after it crashed into the embankment. ██████ estimated he was approximately one hundred yards away when he saw the patrol car ram the ██████ and heard the gunshots. One deputy went to each side of the ██████ and opened the doors. ██████ then saw several other deputies arrive on scene. ██████ did not provide any further information.

INTERVIEW WITH ██████ ██████

██████ is the girlfriend of ██████. ██████ was sitting in the passenger seat of ██████ car. ██████ did not speak any English. I told ██████ to wait in her car until a Spanish-speaking detective arrived to interview her.

I assisted in securing the crime scene and provided security until detectives arrived. I was relieved of providing security at approximately 2330 hours.

13 DATE / TIME OF REPORT 3-21-03 / 1300	14 REPORTING OFFICER / ID NO / DIV / UNIT McCOYVILLE / 3410 / CSU	15 APPROVED BY / ID NO A. Aguilar / 2486
--------------------------------------------	----------------------------------------------------------------------	---------------------------------------------

ADDITIONAL NAMES
REPORT

VENTURA COUNTY SHERIFF'S DEPARTMENT
AGENCY IDENTIFIER CA0560000

Page 1 of 4

1 RB NUMBER
03-8235



CODE	or NAME (Last, First, Middle, Suffix) / FIRM NAME	AKA / Moniker	RACE	SEX	HT	WT	HAIR	EYES	DOB	AGE

CODE	or NAME (Last, First, Middle, Suffix) / FIRM NAME	AKA / Moniker	RACE	SEX	HT	WT	HAIR	EYES	DOB	AGE



93 COMMENTS:

94 DATE / TIME OF REPORT
3-21-03 / 1300

95 REPORTING OFFICER / ID NO. / DIV. / UNIT
MCDONVILLE / 3310 / CSO

96 APPROVED BY / ID NO.
A. [Signature] / 2486

NARRATIVE REPORT VENTURA COUNTY SHERIFF'S DEPARTMENT

Page 1 of 4 Continuation

AGENCY IDENTIFIER CA0560000

1 R.D.
3270

2 BEAT
3C2

3 RB NUMBER
03-8235

4 CODE	5 ITEM	6 QTY.	7 ITEM NAME	8 BRAND / MAKE MANUFACTURER	9 MODEL NAME OR NUMBER	10 MISC. DESCRIPTION	11 IDENTIFICATION / SERIAL NUMBER	12 VALUE
--------	--------	--------	-------------	-----------------------------	------------------------	----------------------	-----------------------------------	----------

Supplemental Case Closed

Gang Domestic Hate Child Abuse Elderly Abuse

Connecting Report Numbers:

Code Section / Description: Officer Involved Shooting

Code: S Name: Pearlman, Nancy

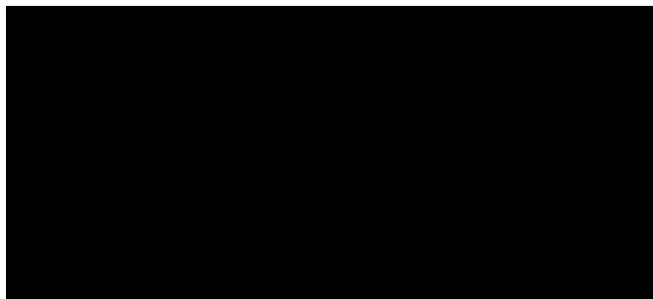

On 3-20-2003, I was informed that there were several possible witnesses that only spoke Spanish who needed to be interviewed. One of these subjects was identified as [REDACTED] [REDACTED]. She was waiting inside her van that was parked just south of the crime scene. [REDACTED] was the lone occupant of the van when I contacted her.

The following is a synopsis of my interview with [REDACTED]. The interview was tape-recorded and the audiotape was later booked as evidence.

I asked [REDACTED] if she knew what time she arrived in the area. [REDACTED] told me it was around 6:45 PM. [REDACTED] said she parked at the extreme south/ east end of the parking area next Mugu Rock. I asked her if she was inside the parking lot or along the roadway. She said she was inside the dirt parking area. [REDACTED] said

13 DATE / TIME OF REPORT 4/1/2003 / 10:46 AM	14 REPORTING OFFICER / ID NO / DIV / UNIT J. Rivera / 2696 / WC / Special Services	15 APPROVED BY / ID NO <i>E. Hernandez</i> 1047
-------------------------------------------------	---------------------------------------------------------------------------------------	----------------------------------------------------

NARRATIVE REPORT VENTURA COUNTY SHERIFF'S DEPARTMENT

1 R.D. 3270	2 BEAT 3C2	3 RB NUMBER 03-8235
----------------	---------------	------------------------

4 CODE	5 ITEM	6 QTY.	7 ITEM NAME	8 BRAND / MAKE MANUFACTURER	9 MODEL NAME OR NUMBER	10 MISC. DESCRIPTION	11 IDENTIFICATION / SERIAL NUMBER	12 VALUE
--------	--------	--------	-------------	-----------------------------	------------------------	----------------------	-----------------------------------	----------

she was parked facing out toward the ocean (south/ west) and was watching the waves.

██████████ said that when she drove in the parking lot there was a male subject in a black "Bronco" type car that was driving in ahead of her. She said there was also a small white car driving in behind her. ██████████ said she parked her van and shortly thereafter, she saw a patrol car driving in the parking lot.

██████████ said the patrol unit came up to the suspect's gray ██████████ that she identified by turning around and pointing at it.

██████████ said the ██████████ drove away and the patrol officer followed behind it. She did not pay any more attention to the patrol car or the ██████████. She later heard the sound of two gunshots that she thought were coming from the shooting range located just north of the parking lot. ██████████ said she thought it might be military personnel who were practicing at the range.

██████████ said she decided to leave at that point. She said she began to drive north to get to the exit when a deputy stopped her and directed her to park her car and wait.

I asked ██████████ how many shots she heard. ██████████ told me she was seated in her car listening to the radio and only heard two shots. ██████████ said that as she drove down she saw the ██████████ where it was at now. I asked her if the patrol cars had their lights on and she said, "Yes."

13 DATE / TIME OF REPORT 4/1/2003 / 10:46 AM	14 REPORTING OFFICER / ID NO / DIV / UNIT J. Rivera / 2696 / WC / Special Services	15 APPROVED BY / ID NO. <i>E. Montoya 1041</i>
-------------------------------------------------	---------------------------------------------------------------------------------------	---------------------------------------------------

NARRATIVE REPORT VENTURA COUNTY SHERIFF'S DEPARTMENT

1 R.D. 3270	2 BEAT 3C2	3 RB NUMBER 03-8235
----------------	---------------	------------------------

4 CODE	5 ITEM	6 QTY.	7 ITEM NAME	8 BRAND / MAKE MANUFACTURER	9 MODEL NAME OR NUMBER	10 MISC. DESCRIPTION	11 IDENTIFICATION / SERIAL NUMBER	12 VALUE
--------	--------	--------	-------------	-----------------------------	------------------------	----------------------	-----------------------------------	----------

██████████ said she saw a patrol car behind the ██████████ and a deputy standing next to the passenger side of the ██████████. She said that Deputy directed her to go passed the scene, but a second deputy stopped and asked for her identification card and then directed her to park her car.

I asked ██████████ if she also saw the other patrol cars. I pointed to Deputies Stephens and Cerio's patrol cars. ██████████ said she was not paying attention and did not remember. ██████████ said she asked the deputy what happened and he told her there was an accident.

I asked ██████████ about the personnel there and how she knew they were law enforcement. She said it was because of their uniform. I asked her if it was a police officer's uniform. She said, "No." ██████████ then began to describe the officers' uniforms as having green pants. She then pointed to a deputy who was standing nearby with a tan and green sheriff's uniform. She said the officers' uniforms were just like that one.

██████████ said she saw about a total of seven deputies when she was driving down the parking lot. She said more personnel began arriving afterwards. I asked ██████████ what the lighting conditions were like when she heard the gunshots. ██████████ said it was not really dark. She said the sun had set, but it was clearer than it was now. ██████████ said she was able to see without any problems.

██████████ pointed south at the direction of a white truck with a camper shell that was parked about 50 to 75 yards south of our location. ██████████ said she was parked near that location and immediately saw the patrol car in the parking lot

13 DATE / TIME OF REPORT 4/1/2003 / 10:46 AM	14 REPORTING OFFICER / ID NO / DIV / UNIT J. Rivera / 2696 / WC / Special Services	15 APPROVED BY / ID NO <i>E. Montoya</i> / 1047
-------------------------------------------------	---------------------------------------------------------------------------------------	----------------------------------------------------

NARRATIVE REPORT VENTURA COUNTY SHERIFF'S DEPARTMENT

Page 4 of 4

Continuation

AGENCY IDENTIFIER CA0560000

1 R.D.
3270

2 BEAT
3C2

3 RB NUMBER
03-8235

4 CODE	5 ITEM	6 QTY.	7 ITEM NAME	8 BRAND / MAKE MANUFACTURER	9 MODEL NAME OR NUMBER	10 MISC. DESCRIPTION	11 IDENTIFICATION / SERIAL NUMBER	12 VALUE
--------	--------	--------	-------------	-----------------------------	------------------------	----------------------	-----------------------------------	----------

further north. She said the emergency lights were turned on and that was how she knew it was a patrol car.

I asked [redacted] if she heard any of the officers saying anything to the person in the [redacted]. [redacted] said she did not hear anything. [redacted] said that by the time she reached the scene, it was in the manner it was now in. She said she saw the subject seated inside the [redacted] that had the windows broken.

I did not have any further questions for [redacted] at this time so I concluded my interview with her.

13 DATE / TIME OF REPORT 4/1/2003 / 10:46 AM	14 REPORTING OFFICER / ID NO / DIV / UNIT J. Rivera / 2696 / WC / Special Services	15 APPROVED BY / ID NO E. [Signature] 1047
-------------------------------------------------	---------------------------------------------------------------------------------------	-----------------------------------------------

NARRATIVE REPORT VENTURA COUNTY SHERIFF'S DEPARTMENT

Page 1 of 3 Continuation

AGENCY IDENTIFIER CA0560000

1 R.D. 3270	2 BEAT 3C2	3 RB NUMBER 03-8235
----------------	---------------	------------------------

4 CODE	5 ITEM	6 QTY.	7 ITEM NAME	8 BRAND / MAKE MANUFACTURER	9 MODEL NAME OR NUMBER	10 MISC. DESCRIPTION	11 IDENTIFICATION / SERIAL NUMBER	12 VALUE
--------	--------	--------	-------------	-----------------------------	------------------------	----------------------	-----------------------------------	----------

Supplemental Case Closed

Gang Domestic Hate Child Abuse Elderly Abuse

Connecting Report Numbers:

Code Section / Description: Officer Involved Shooting

Code: S Name: Pearlman, Nancy

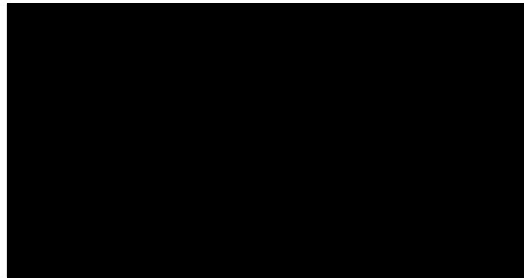

On 3-20-2003, I interviewed [REDACTED] [REDACTED] regarding this case. [REDACTED] is a Spanish speaker so I conducted my interview with him in Spanish. The interview was tape-recorded and the following is a synopsis. The audiotape was later booked as evidence.

[REDACTED] told me he was not sure what time he arrived in the parking lot. He said about five minutes after he arrived he saw a police car drive in the parking lot. He said the police officer drove up to and shined his lights at a vehicle he described as being a van. [REDACTED] looked at the suspect's [REDACTED] and said he thought that was the vehicle the officer shined his lights at.

[REDACTED] said that after the officer shined his lights at the [REDACTED], he heard the officer saying something to the occupant. [REDACTED] said he was standing outside

13 DATE / TIME OF REPORT 4/1/2003 / 4:42 PM	14 REPORTING OFFICER / ID NO / DIV / UNIT J. Rivera / 2696 / WC / Special Services	15 APPROVED BY / ID NO <i>E. Montoya</i> 1017
------------------------------------------------	---------------------------------------------------------------------------------------	--------------------------------------------------

NARRATIVE REPORT VENTURA COUNTY SHERIFF'S DEPARTMENT

Page 2 of 3

A Continuation

AGENCY IDENTIFIER CA0560000

1 R.D. 3270	2 BEAT 3C2	3 RB NUMBER 03-8235
----------------	---------------	------------------------

4 CODE	5 ITEM	6 QTY.	7 ITEM NAME	8 BRAND / MAKE MANUFACTURER	9 MODEL NAME OR NUMBER	10 MISC. DESCRIPTION	11 IDENTIFICATION / SERIAL NUMBER	12 VALUE
--------	--------	--------	-------------	-----------------------------	------------------------	----------------------	-----------------------------------	----------

his truck at the south/ east end of the parking lot and was walking around to the back to retrieve a flashlight. He said he saw [REDACTED] start up and then back up. The [REDACTED] then traveled north/ west through the parking lot. He said the police officer followed them in his police car that now had its emergency lights on.

[REDACTED] said he got the flashlight out of the back of his truck and was shining out toward Mugu Rock. He then decided to sit inside his truck and listen to the soccer game on the radio. [REDACTED] said he saw a different van that was parked a short distance away from him leave and travel towards the exit. He said that a short time later he also decided to leave.

I asked [REDACTED] if he saw the [REDACTED] drive in the parking lot. He said he thinks the [REDACTED] was already parked there when he arrived. He said that when he drove in the parking lot there was a small white car that followed him in the lot. He then saw a dark colored van park at the very end (south/ east) of the parking lot.

I asked [REDACTED] where the [REDACTED] was parked when he arrived. He said the [REDACTED] was parked on the south/ west side of the parking lot about 50 yards away from him. He said the [REDACTED] was facing the ocean.

[REDACTED] said that he though the officer first shined his spotlight at the [REDACTED] before activating his emergency lights after he arrived. I asked him if he saw the officer get out of his police car. He said he saw the officer get out of the car and yelled something at the occupant of the [REDACTED]. He next saw the [REDACTED] backing up at a slow speed and travel north/ west down the parking lot.

13 DATE / TIME OF REPORT 4/1/2003 / 4:42 PM	14 REPORTING OFFICER / ID NO / DIV / UNIT J. Rivera / 2696 / WC / Special Services	15 APPROVED BY / ID NO <i>E. Montoya</i> 1017
------------------------------------------------	---------------------------------------------------------------------------------------	--------------------------------------------------

NARRATIVE REPORT VENTURA COUNTY SHERIFF'S DEPARTMENT

Page 3 of 3 Continuation

AGENCY IDENTIFIER CA0560000

1 R.D. 3270	2 BEAT 3C2	3 RB NUMBER 03-8235
----------------	---------------	------------------------

4 CODE	5 ITEM	6 QTY.	7 ITEM NAME	8 BRAND / MAKE MANUFACTURER	9 MODEL NAME OR NUMBER	10 MISC. DESCRIPTION	11 IDENTIFICATION / SERIAL NUMBER	12 VALUE
--------	--------	--------	-------------	-----------------------------	------------------------	----------------------	-----------------------------------	----------

██████████ said the police officer got in his car and pursued the ██████████. ██████████ said he was sure the officer had all of his lights on at this time. I asked ██████████ if the officer also turned on his siren. ██████████ said he heard the sound of a siren, but it was in bursts and not a constant noise. ██████████ said he thinks that the ██████████'s lights were off as it drove away.

I asked ██████████ when he last saw the ██████████. He said he lost sight of the ██████████ and police car as they were traveling down the parking lot due to the incline and the location where he was parked. He said he was sitting in his car and did not pay any further attention to the ██████████ or the police car. I asked ██████████ if he heard any shots being fired. He said he did not hear anything because he had the radio on and his passenger side window was closed. I asked him if he heard the sound of cars colliding. He said, "No."

██████████ said he thought the police were following the ██████████ in order to give the driver a ticket. He said he did not know what had happened until he decided to leave and drove to the exit at the bottom of the parking lot.

██████████ said he saw another police car traveling south/ east on Pacific Coast Highway as he lost sight of the ██████████ and the first police car. He said the second police car was traveling very fast. ██████████ said that as he was driving down a police officer stopped him and had him park his truck.

I did not have any further questions for ██████████ at this time, so I concluded my interview with him. No further details.

13 DATE / TIME OF REPORT 4/1/2003 / 4:42 PM	14 REPORTING OFFICER / ID NO / DIV / UNIT J. Rivera / 2696 / WC / Special Services	15 APPROVED BY / ID NO E. Montoya 1017
------------------------------------------------	---------------------------------------------------------------------------------------	-------------------------------------------

NARRATIVE REPORT VENTURA COUNTY SHERIFF'S DEPARTMENT

Page 1 of 3 Continuation

AGENCY IDENTIFIER CA0560000

1 R.D. 3270	2 BEAT 3C2	3 RB NUMBER 03-8235
----------------	---------------	------------------------

4 CODE	5 ITEM	6 QTY.	7 ITEM NAME	8 BRAND / MAKE MANUFACTURER	9 MODEL NAME OR NUMBER	10 MISC. DESCRIPTION	11 IDENTIFICATION / SERIAL NUMBER	12 VALUE
--------	--------	--------	-------------	-----------------------------	------------------------	----------------------	-----------------------------------	----------

Supplemental Case Closed

Gang Domestic Hate Child Abuse Elderly Abuse

Connecting Report Numbers:

Code Section / Description: Officer Involved Shooting

Code: S Name: Pearlman, Nancy

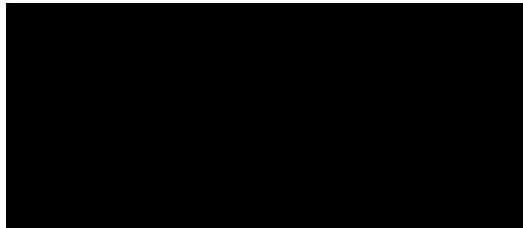

On 3-20-2003, I interviewed [REDACTED] [REDACTED] [REDACTED] regarding this case. [REDACTED] is a Spanish speaker so I conducted my interview with him in Spanish. The interview was tape-recorded and the following is a synopsis. The audiotape was later booked as evidence.

[REDACTED] said he was parked at the south/ east end of the parking lot. This area is elevated from the rest of the parking lot. He said he was parked on the south side of the parking lot facing north. [REDACTED] said he and his girlfriend, [REDACTED] [REDACTED], arrived in the parking lot at about 1800 hours. He mentioned that the sun had gone down by the time they arrived.

I pointed to the suspect's [REDACTED] and asked him if that vehicle was already in the parking lot when they arrived. He said it had not arrived. I asked him if he had

13 DATE / TIME OF REPORT 4/1/2003 / 10:45 AM	14 REPORTING OFFICER / ID NO / DIV / UNIT J. Rivera / 2696 / WC / Special Services	15 APPROVED BY / ID NO <i>E. Montefino</i> 1047
-------------------------------------------------	---------------------------------------------------------------------------------------	----------------------------------------------------

NARRATIVE REPORT VENTURA COUNTY SHERIFF'S DEPARTMENT

Page 2 of 3

Continuation

AGENCY IDENTIFIER CA0560000

1 R.D. 3270	2 BEAT 3C2	3 RB NUMBER 03-8235
----------------	---------------	------------------------

4	5	6	7	8	9	10	11	12
DE	ITEM	QTY.	ITEM NAME	BRAND / MAKE MANUFACTURER	MODEL NAME OR NUMBER	MISC. DESCRIPTION	IDENTIFICATION / SERIAL NUMBER	VALUE

seen the [REDACTED] arrive. He said they did not see it come in and did not see it until the police car arrived. He said he saw the [REDACTED] at the north/ west end of the parking lot near the entrance by an orange traffic cone. He said the [REDACTED] stopped and the police car was stopped behind it blocking the [REDACTED]'s path. [REDACTED] said a second police car arrived in the parking lot and shortly afterwards he heard one gunshot.

[REDACTED] said he did not know where or who had fired the gunshot. [REDACTED] said he and [REDACTED] dove to the ground after hearing the gunshot. He said they rolled down the embankment and lost sight of the [REDACTED] and the two police cars. [REDACTED] said he heard a total of two or three gunshots.

I asked him if he heard anyone yelling or giving orders. He said he heard a police officer telling someone to stop. [REDACTED] then explained that he and [REDACTED] were walking down from their car to the restrooms. The restrooms are located on the south side of the parking lot across from the entrance. He said that was when they heard the gunshots and they dove to the ground.

I asked [REDACTED] to show me where they were when they got down on the ground. He pointed to an area near the two lifeguard towers located on the south side of the parking lot about 100 feet south/ east from the entrance. There is a small embankment located between the parking lot and the lifeguard towers.

[REDACTED] said he saw one of the officers put his hand out in the direction of the [REDACTED] and heard the officer tell the driver to stop. [REDACTED] said the officer partially got out of his police car and told the driver of the [REDACTED] to stop. He said the

13 DATE / TIME OF REPORT 4/1/2003 / 10:45 AM	14 REPORTING OFFICER / ID NO / DIV / UNIT J. Rivera / 2696 / WC / Special Services	15 APPROVED BY / ID NO E. Montefur 1047
-------------------------------------------------	---------------------------------------------------------------------------------------	--------------------------------------------

NARRATIVE REPORT VENTURA COUNTY SHERIFF'S DEPARTMENT

Page 3 of 3

Continuation

AGENCY IDENTIFIER CA0560000

1 R.D.
3270

2 BEAT
3C2

3 RB NUMBER
03-8235

4 CODE	5 ITEM	6 QTY.	7 ITEM NAME	8 BRAND / MAKE MANUFACTURER	9 MODEL NAME OR NUMBER	10 MISC. DESCRIPTION	11 IDENTIFICATION / SERIAL NUMBER	12 VALUE
--------	--------	--------	-------------	-----------------------------	------------------------	----------------------	-----------------------------------	----------

officer told the driver something else that he did not understand because he was speaking in English. He said the [REDACTED] accelerated and that was when he and [REDACTED] dove to the ground.

I asked [REDACTED] if the [REDACTED] was traveling in their direction (south). He said the [REDACTED] was "burning rubber" as it traveled south. He said the [REDACTED] came to rest at its present location. I asked [REDACTED] if he saw any of the patrol cars collide with the [REDACTED]. He said, "No."

[REDACTED] said they stayed down on the ground for about seven minutes before they decided to get up. He said he could hear the officers talking and saw another patrol car arriving. I asked [REDACTED] if the patrol car blocking the [REDACTED] had its emergency and spotlight turned on. [REDACTED] said, "It had all of its lights on."

I asked [REDACTED] if there was just one police car following the [REDACTED] in the beginning. He said, "Yes", and that a second police car arrived shortly afterwards. He said the second police car also had all of its lights on. I asked [REDACTED] if the two police cars were black and white like the ones parked a short distance away from us. I pointed to the two units that had been driven by Deputies Stephens and Cerio when I asked him this question. He the two police cars were just like those two police cars.

I did not have any further questions for [REDACTED] at this time so I concluded my interview with him.

13 DATE / TIME OF REPORT 4/1/2003 / 10:45 AM	14 REPORTING OFFICER / ID NO / DIV / UNIT J. Rivera / 2696 / WC / Special Services	15 APPROVED BY / ID NO <i>E. Montoya</i> / 1047
-------------------------------------------------	---------------------------------------------------------------------------------------	----------------------------------------------------

NARRATIVE REPORT VENTURA COUNTY SHERIFF'S DEPARTMENT

Page 1 of 11 Continuation

AGENCY IDENTIFIER CA0560000

1 R.D. 3261	2 BEAT 3C02	3 RB NUMBER 2003-08235
----------------	----------------	---------------------------

4 CODE	5 ITEM	6 QTY.	7 ITEM NAME	8 BRAND / MAKE MANUFACTURER	9 MODEL NAME OR NUMBER	10 MISC. DESCRIPTION	11 IDENTIFICATION / SERIAL NUMBER	12 VALUE
--------	--------	--------	-------------	-----------------------------	------------------------	----------------------	-----------------------------------	----------

- Supplemental Case Cleared
 Gang Domestic Hate Child Abuse Elderly Abuse

Connecting Report Numbers:

Code Section / Description: Dead Body

Reclassify to:

Code: V-1 Name: Pearlman, Nancy

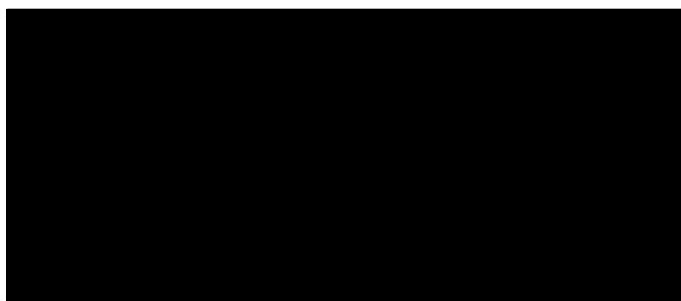

On 3-26-03 at 1654 hours, I received a message on my office voice mail from a male who identified himself at [REDACTED] telling me he and his wife were personal friends of [REDACTED] and Nancy Pearlman. [REDACTED] left his phone number [REDACTED] and volunteered to give me any information about the Pearlmans. [REDACTED] said that he was the person who went with Nancy to see a divorce attorney within the two weeks prior to her death.

At about 1800 the same day, I called [REDACTED] and spoke to a man who identified himself as "[REDACTED]." I identified myself as Mike Powers with Ventura Sheriff's.

[REDACTED] said that he and his wife [REDACTED] have known [REDACTED] and Nancy Pearlman for 15 years. [REDACTED] said that Nancy relied upon he and [REDACTED] to help her through the many "tumultuous" times that she and [REDACTED] had in their marriage. [REDACTED] said that Nancy called him and asked him to go with her to meet a divorce attorney twice in the last 3 weeks, the last time being last Tuesday (3-18-03). [REDACTED] said that Nancy was seeing a psychiatrist at Kaiser Permanente, he believes in Woodland Hills. [REDACTED] said that Nancy was a very weak person; "she could never make a decision at all." [REDACTED] said that [REDACTED] emotionally "beat her down" all the time. [REDACTED] said [REDACTED] was completely in control of his and Nancy's lives.

13 DATE / TIME OF REPORT 04-01-03 / 0925	14 REPORTING OFFICER / ID NO / DIV / UNIT Sgt. M. Powers/#1365/Special Services	15 APPROVED BY / ID NO Sgt. Montagna #1047 <i>[Signature]</i>
---------------------------------------------	------------------------------------------------------------------------------------	------------------------------------------------------------------

NARRATIVE REPORT VENTURA COUNTY SHERIFF'S DEPARTMENT

Page 2 of 11

Continuation

AGENCY IDENTIFIER CA0560000

1 R.D. 3261	2 BEAT 3C02	3 RB NUMBER 2003-08235
----------------	----------------	---------------------------

4 CODE	5 ITEM	6 QTY.	7 ITEM NAME	8 BRAND / MAKE MANUFACTURER	9 MODEL NAME OR NUMBER	10 MISC. DESCRIPTION	11 IDENTIFICATION / SERIAL NUMBER	12 VALUE
--------	--------	--------	-------------	-----------------------------	------------------------	----------------------	-----------------------------------	----------

█████ obtained his day planner and returned to the phone. █████ said that on Monday 3-3-03, he and Nancy went to a divorce attorney for Nancy. █████ obtained the attorney's business card and returned to the phone. █████ identified the attorney as:



I asked █████ to give me his history with the Pearlman's. █████ said that he and his wife █████ took a cruise to the Mexican Rivera in 1987. █████ said that █████ and Nancy sat at their dining table during the cruise and that was when they met. █████ said at that time, █████ and Nancy were just getting back together after having been separated, according to both █████ and Nancy.

█████ said that █████ left Nancy twice between 1987 and 1995 that he knew of. █████ said that after meeting in 1987, he █████, █████ and Nancy went to the theatre together. █████ said that one time (date not given), Nancy told him after the theatre that she would not see them again, because she and █████ were breaking up and she was moving to █████ with her parents. █████ said that Nancy went to █████ for a while, but came back to █████ (where she and █████ lived at the time) and everything was fine again.

█████ explained that each time █████ and Nancy separated, they split their assets. █████ said that █████ would "blow through what ever money he took on his side and Nancy would squirrel away the money she took." █████ said that when █████ and Nancy got back together, it was because █████ had run out of money. █████ said that he can't say that █████ ever treated Nancy badly "or didn't give her everything that she would have wanted." █████ said that Nancy just wanted to be a good wife to █████.

█████ said that █████ has always been jealous of his and █████ relationship with their children. █████ said that █████ has two sons, █████ and █████, who are from a former marriage. █████ said

13 DATE / TIME OF REPORT 04-01-03 / 0925	14 REPORTING OFFICER / ID NO / DIV / UNIT Sgt. M. Powers/#1365/Special Services	15 APPROVED BY / ID NO Sgt. Montagna #1047 <i>Em</i>
---------------------------------------------	------------------------------------------------------------------------------------	---------------------------------------------------------

NARRATIVE REPORT VENTURA COUNTY SHERIFF'S DEPARTMENT

Page 3 of 11

Continuation

AGENCY IDENTIFIER CA0560000

1 R.D. 3261	2 BEAT 3C02	3 RB NUMBER 2003-08235
----------------	----------------	---------------------------

4 CODE	5 ITEM	6 QTY.	7 ITEM NAME	8 BRAND / MAKE MANUFACTURER	9 MODEL NAME OR NUMBER	10 MISC. DESCRIPTION	11 IDENTIFICATION / SERIAL NUMBER	12 VALUE
--------	--------	--------	-------------	-----------------------------	------------------------	----------------------	-----------------------------------	----------

that Adam and Brian were about 2-4 years old when [redacted] and Nancy married. [redacted] said that [redacted] and Nancy told him that Adam and Brian hated her because she was the woman that drove [redacted] away from their mother.

[redacted] said that in (he believes) 1990, [redacted] left Nancy. [redacted] said that [redacted] kissed Nancy good-bye one morning. Nancy went to [redacted] and was locked in a mental health facility for 30 days. I asked why Nancy was confined to the mental health facility. [redacted] said that Nancy was working for a doctor at the time and was afraid the doctor was going to send someone to kill her because she was office help who knew the inner workings of his office.

[redacted] said that after he retired, around 1995, Nancy called him and [redacted] stating that [redacted] had left her. [redacted] said that Nancy told him that [redacted] was supposedly going to work one day, but actually had his sons help him move out of their house in [redacted]. [redacted] said that [redacted] took several household items and left a note to Nancy on the bed (informing her he was leaving her). [redacted] said that Nancy told him that [redacted] called her on the phone at her work during the day and told her to summon someone to sit with her because he had something to tell her. [redacted] told Nancy that their marriage was over. [redacted] said that Nancy told him that [redacted] told her the reason their relationship was over was because [redacted] wanted to have a relationship with his sons like the [redacted] had with their children; and with Nancy in [redacted] life, that can't happen, because they hated Nancy. [redacted] told Nancy to call the [redacted] because they would take care of her. [redacted] said that Nancy called him and [redacted] and relayed this information to them. [redacted] said that he and [redacted] "kind of babysat her for like three weeks." [redacted] called [redacted] the next day and gave him the same rationale for leaving Nancy.

[redacted] said that [redacted] and Nancy got back together after about 4-5 months. [redacted] said that Nancy told him that they split up their monies and [redacted] went through his money and came back to her. Nancy told [redacted] she willingly took [redacted] back each time after they broke up. I asked [redacted] if Nancy ever told them she pursued [redacted] asking him to come back with her. [redacted] said, "No" but added he wouldn't be surprised if she would plead with [redacted] to come back when she spoke with him, "because that was the kind of person she was."

13 DATE / TIME OF REPORT 04-01-03 / 0925	14 REPORTING OFFICER / ID NO / DIV / UNIT Sgt. M. Powers/#1365/Special Services	15 APPROVED BY / ID NO Sgt. Montagna #1047 <i>[Signature]</i>
---------------------------------------------	------------------------------------------------------------------------------------	------------------------------------------------------------------

NARRATIVE REPORT VENTURA COUNTY SHERIFF'S DEPARTMENT

Page 4 of 11 Continuation

AGENCY IDENTIFIER CA0560000

1 R.D. 3261	2 BEAT 3C02	3 RB NUMBER 2003-08235
----------------	----------------	---------------------------

4 CODE	5 ITEM	6 QTY.	7 ITEM NAME	8 BRAND / MAKE MANUFACTURER	9 MODEL NAME OR NUMBER	10 MISC. DESCRIPTION	11 IDENTIFICATION / SERIAL NUMBER	12 VALUE
--------	--------	--------	-------------	-----------------------------	------------------------	----------------------	-----------------------------------	----------

[redacted] said that [redacted] and Nancy bought a house in [redacted] that was going to be their retirement house. [redacted] said that he spoke to a cousin, [redacted] and [redacted] who was also friends with [redacted] and Nancy. [redacted] worked for [redacted] for about 6 months at [redacted]. [redacted] said that at the time, [redacted] and Nancy's relationship was again waning; living in the same residence in [redacted], but in an estranged manner. [redacted] said that his cousin told him he had been invited to [redacted]'s [redacted] residence and there was a woman from [redacted] there with [redacted].

[redacted] said that he and [redacted] invited Nancy to their house for dinner and told Nancy about the woman from [redacted]. Nancy asked if the woman's name was ([redacted] couldn't remember the woman's name but Nancy guessed it correctly). [redacted] asked Nancy how she knew the woman from [redacted]'s name. Nancy told [redacted] that [redacted] had an affair with the woman from [redacted] several years prior, but said it would never happen again. [redacted] said Nancy fainted and awoke a while later. [redacted] was on his way to [redacted] to attend a jazz festival. [redacted] said Nancy called [redacted] in his car and confronted him with the woman from [redacted]. [redacted] only admitted the woman was at [redacted] with him.

[redacted] said that Nancy told him that [redacted] didn't show up for dinner from time to time, coming home late. [redacted] said that [redacted] would then tell Nancy that he was out with other women. [redacted] said that Nancy told [redacted] not to tell her these things.

[redacted] said that 4 years ago, while they were then living in [redacted] Nancy found that [redacted] had made contact with a Russian female on the computer while surfing the Internet. [redacted] said that Nancy told him that [redacted] began to chat with the Russian female, [redacted] when she was about 24 years old. [redacted] said that [redacted] was a tour guide in Turkey, giving Russian tours in Turkey. [redacted] denied "anything" was happening, but [redacted] was planning on bring [redacted] to live with them, against Nancy's objections. [redacted] told Nancy that [redacted] was like a daughter to him and they had established a wonderful (father/daughter) relationship. [redacted] brought [redacted] to America and she lived in the Camarillo home with [redacted] and Nancy, with Nancy feeling she

13 DATE / TIME OF REPORT 04-01-03 / 0925	14 REPORTING OFFICER / ID NO / DIV / UNIT Sgt. M. Powers/#1365/Special Services	15 APPROVED BY / ID NO Sgt. Montagna #1047 <i>cm</i>
---------------------------------------------	------------------------------------------------------------------------------------	---------------------------------------------------------

NARRATIVE REPORT VENTURA COUNTY SHERIFF'S DEPARTMENT

Page 5 of 11

Continuation

AGENCY IDENTIFIER CA0560000

1 R.D. 3261	2 BEAT 3C02	3 RB NUMBER 2003-08235
----------------	----------------	---------------------------

4 CODE	5 ITEM	6 QTY.	7 ITEM NAME	8 BRAND / MAKE MANUFACTURER	9 MODEL NAME OR NUMBER	10 MISC. DESCRIPTION	11 IDENTIFICATION / SERIAL NUMBER	12 VALUE
--------	--------	--------	-------------	-----------------------------	------------------------	----------------------	-----------------------------------	----------

had no say in the situation. Nancy accepted the situation and told [REDACTED] and [REDACTED] saying that Nancy really was a nice person, "like the daughter I never had." [REDACTED] and Nancy went with [REDACTED] to Turkey. When they came back from Turkey, [REDACTED] got [REDACTED] a car.

I told [REDACTED] that I did see a female at the Pearlman's residence when I was there and asked [REDACTED] if [REDACTED] had any daughters. [REDACTED] said [REDACTED] didn't have any daughters. [REDACTED] said that it had to be [REDACTED] that I saw, since she would be the only female in the house (besides Nancy).

[REDACTED] said that [REDACTED] only went to [REDACTED] with Nancy about half of the times she went there. The other times [REDACTED] would stay at the house in [REDACTED]

[REDACTED] said that Nancy always felt that the good part of the marriage was coming and never wanted to get a divorce. [REDACTED] said that Nancy was "very proud" that in November 2002, [REDACTED] had just bought Nancy her first real 1 ¼ ct. round diamond ring. [REDACTED] said that all Nancy's jewelry up to that point, although beautiful, were CZ stones. Nancy felt because [REDACTED] had bought her the real diamond ring, which was a sign that their marriage was going to work out.

[REDACTED] said that he helped Nancy copy some bills just before going to the attorney on 3-18-03, and saw a \$13,000.00 charge from a jeweler on an ([REDACTED]'s) American Express bill. [REDACTED] said he used to be in the jewelry business and knows that a 1 ¼ ct. diamond, unless it is "D" flawless does not sell for \$13,000.00. Nancy told [REDACTED] that the diamond that [REDACTED] originally gave her had a visible flaw, so [REDACTED] went and exchanged it. [REDACTED] speculated that [REDACTED] bought more than Nancy's ring with the \$13,000.00. [REDACTED] estimated a 1 ¼ ct. good quality diamond would sell for about \$5,000.00. Nancy didn't ever show [REDACTED] the diamond ring [REDACTED] had bought her.

[REDACTED] said that Nancy recently came home to the house in Camarillo and found two airline tickets to London, England. One was in [REDACTED]'s name and the other was in [REDACTED]'s manicurist's name, who [REDACTED] thinks is named [REDACTED]. Nancy confronted [REDACTED] about the tickets for him and [REDACTED] to London. Nancy told [REDACTED] that [REDACTED] confirmed that he was taking [REDACTED] to London.

13 DATE / TIME OF REPORT 04-01-03 / 0925	14 REPORTING OFFICER / ID NO / DIV / UNIT Sgt. M. Powers / #1365 / Special Services	15 APPROVED BY / ID NO Sgt. Montagna #1047 <i>GM</i>
---------------------------------------------	----------------------------------------------------------------------------------------	---------------------------------------------------------

NARRATIVE REPORT VENTURA COUNTY SHERIFF'S DEPARTMENT

Page 6 of 11

Continuation

AGENCY IDENTIFIER CA0560000

1 R.D.
3261

2 BEAT
3C02

3 RB NUMBER
2003-08235

4 CODE	5 ITEM	6 QTY.	7 ITEM NAME	8 BRAND / MAKE MANUFACTURER	9 MODEL NAME OR NUMBER	10 MISC. DESCRIPTION	11 IDENTIFICATION / SERIAL NUMBER	12 VALUE
--------	--------	--------	-------------	-----------------------------	------------------------	----------------------	-----------------------------------	----------

and wouldn't change his plans, asking Nancy to stay in the Camarillo home and take care of the dogs. [REDACTED] added that Nancy sometimes "embellished" on the truth.

Nancy told [REDACTED] that [REDACTED] didn't want her to retain a divorce attorney other than to formalize his proposed settlement agreement. [REDACTED] suggested that Nancy retain Wilson. [REDACTED] said that when he and Nancy went to Wilson (her divorce attorney) on 3-3-03, she gave Wilson [REDACTED]'s proposed divorce settlement agreement. Nancy told [REDACTED] that she was leaving the night of 3-3-03 and going to [REDACTED] for a week. [REDACTED] said that Nancy didn't communicate with Wilson in the week and a half she was in [REDACTED]. [REDACTED] asked Nancy why she didn't communicate with Wilson and Nancy said she was told to get a second opinion on an attorney. [REDACTED] told Nancy he felt Wilson was a good attorney and convinced her to see Wilson again, making an appointment to see Wilson on 3-18-03.

[REDACTED] and Nancy went to Wilson's office on 3-18-03. Wilson suggested that they could make a temporary separation agreement and asked Nancy for input on thing she wanted. [REDACTED] said that [REDACTED] and Nancy owned a house in [REDACTED] valued at about \$350,000.00, in addition to the house in Camarillo [REDACTED] said they purchased for \$872,000.00.

Nancy told [REDACTED] that [REDACTED] told her that he wanted her personal heirlooms out of the Camarillo house and he was going to change the locks on the Camarillo house as soon as he came back from London (on 3-20-03). Nancy told [REDACTED] that she wanted to stay in the Camarillo home and use one of their vehicles kept at the Camarillo home when she was in Camarillo. Wilson told Nancy that she had to discuss these issues with [REDACTED]. [REDACTED] felt they had made progress at Wilson's office, with Nancy thinking she and [REDACTED] weren't going to file for separation, she wasn't give Wilson a retainer, Wilson was going to wait for Nancy to get back to her to draft the separation agreement to her satisfaction.

[REDACTED] knew this was going to be confrontational for Nancy and told her that if she wanted him and [REDACTED] to be there in a supporting role when she discussed these issues with [REDACTED], he would come and help her. They ended their lunch and Nancy wrote down the points she had to

13 DATE / TIME OF REPORT
04-01-03 / 0925

14 REPORTING OFFICER / ID NO / DIV / UNIT
Sgt. M. Powers / #1365 / Special Services

15 APPROVED BY / ID NO
Sgt. Montagna #1047 *AM*

NARRATIVE REPORT VENTURA COUNTY SHERIFF'S DEPARTMENT

Page 7 of 11

Continuation

AGENCY IDENTIFIER CA0560000

1 R.D.
3261

2 BEAT
3C02

3 RB NUMBER
2003-08235

4 CODE	5 ITEM	6 QTY.	7 ITEM NAME	8 BRAND / MAKE MANUFACTURER	9 MODEL NAME OR NUMBER	10 MISC. DESCRIPTION	11 IDENTIFICATION / SERIAL NUMBER	12 VALUE
--------	--------	--------	-------------	-----------------------------	------------------------	----------------------	-----------------------------------	----------

discuss with [REDACTED] and that was the last time [REDACTED] saw Nancy on the afternoon of Tuesday 3-18-03.

[REDACTED] said that he next heard from [REDACTED] on 3-20-03 at about 2300 hours when he called and said, "[REDACTED] I have some terrible news. Nancy has been shot to death by the police." [REDACTED] asked how did it happen. [REDACTED] said [REDACTED] told him that he had taken his mother to dinner and left Nancy in the house. [REDACTED] to [REDACTED] that he came home found an open gun case open and Nancy's cell phone. [REDACTED] told [REDACTED] that was Nancy's method of saying "good-bye."

[REDACTED] said that on 3-3-03, Nancy told him that she had hidden the gun. [REDACTED] called [REDACTED] a couple of days later and told [REDACTED] he was going to Lon [REDACTED] and knew Nancy was coming back to the house in Camarillo. [REDACTED] asked [REDACTED] if Nancy had asked him to store anything for her. [REDACTED] told [REDACTED] "No" and inquired why he was asking. [REDACTED] told [REDACTED] a gun was missing and asked [REDACTED] if he knew anything about the gun. [REDACTED] told [REDACTED] that Nancy told him she "hid" the gun, but didn't tell him where. Neither [REDACTED] nor Nancy ever told [REDACTED] when Nancy had taken the gun from, or spoken about another gun being stored in the same place as the one she took and hid. [REDACTED] told [REDACTED] that he thought Nancy might do something bad with the gun. [REDACTED] asked [REDACTED] what she thought Nancy might do with the gun. [REDACTED] feared for [REDACTED]'s safety when he was in Lon [REDACTED] because Nancy hated [REDACTED]. [REDACTED] said that [REDACTED] never expressed concern about Nancy harming herself during that conversation, only concern for [REDACTED]'s safety.

[REDACTED] said that he believed [REDACTED] had two Glock pistols and showed him one Glock pistol with a laser sight. [REDACTED] thought they had another Glock at that house as well. [REDACTED] said Nancy called him and [REDACTED] to come drive [REDACTED]'s Ford Explorer home one time. [REDACTED] went to get to the key card code from the glove compartment and found a loaded small chrome pistol in the glove compartment.

Continuing with what [REDACTED] told [REDACTED] on 3-20-03 at 2300 hours, [REDACTED] said that he had called the police at 1842 hours, Nancy had rammed a police car (inaccurate information I had given to [REDACTED]), and she had been shot and killed by the police.

13 DATE / TIME OF REPORT
04-01-03 / 0925

14 REPORTING OFFICER / ID NO / DIV / UNIT
Sgt. M. Powers/#1365/Special Services

15 APPROVED BY / ID NO
Sgt. Montagna #1047 *CM*

NARRATIVE REPORT VENTURA COUNTY SHERIFF'S DEPARTMENT

Page 8 of 11

Continuation

AGENCY IDENTIFIER CA0560000

1 R.D.
3261

2 BEAT
3C02

3 RB NUMBER
2003-08235

4 CODE	5 ITEM	6 QTY.	7 ITEM NAME	8 BRAND / MAKE MANUFACTURER	9 MODEL NAME OR NUMBER	10 MISC. DESCRIPTION	11 IDENTIFICATION / SERIAL NUMBER	12 VALUE
--------	--------	--------	-------------	-----------------------------	------------------------	----------------------	-----------------------------------	----------

████ said that he called █████ on Sunday (3-23-03) and █████ said there were a lot of unanswered questions in his mind. █████ and I talked about what █████ had been told and told him about the Nancy's death and that he hadn't been notified of her death for a few hours. █████ wondered about how █████ received the information he was telling him about Nancy's death being an officer involved shooting. █████ told me that he been a volunteer at LAPD Devonshire Station for 10 years and wondered who gave █████ all the information he had. I told █████ that I gave him the information.

I confirmed some of what █████ had told █████ and explained to █████ that there were only two officers present, both shot at the tires and only one shot Nancy after she pointed a gun at him. █████ said, "I, I, in my own mind, I said to myself, I don't think Nancy had the ability to kill herself. I think she had tried to commit suicide once before, but all I thought of was suicide by cop." I told █████ that was what the indications were at this time.

I asked █████ what led him to believe that Nancy had tried to commit suicide once in the past. █████ said that it was just came up in some conversation over the past 15 years. █████ told █████ that he didn't believe that Nancy would ever kill herself with a gun, with pills yes, but not a gun.

I asked █████ about Nancy's spirit on the afternoon of 3-18-03. █████ said that Nancy knew she had to confront █████ with some issues, but was reluctant to confront █████ about the 6 issues. █████ excused himself to review a pad of paper with the 6 issues Nancy was going to discuss with █████. █████ commented that █████ wasn't his favorite person and didn't deserve a penny if he was going to sue the department for wrongful death, after all the bad things he put Nancy through.

The six issues Nancy had to confront █████ about after 3-18-03:

1. █████ wouldn't change the locks and alarm codes on the Camarillo house because she intended to continue living there.

13 DATE / TIME OF REPORT
04-01-03 / 0925

14 REPORTING OFFICER / ID NO / DIV / UNIT
Sgt. M. Powers / #1365 / Special Services

15 APPROVED BY / ID NO
Sgt. Montagna #1047 *GM*

NARRATIVE REPORT VENTURA COUNTY SHERIFF'S DEPARTMENT

Page 9 of 11

Continuation

AGENCY IDENTIFIER CA0560000

1 R.D. 3261	2 BEAT 3C02	3 RB NUMBER 2003-08235
----------------	----------------	---------------------------

4 CODE	5 ITEM	6 QTY.	7 ITEM NAME	8 BRAND / MAKE MANUFACTURER	9 MODEL NAME OR NUMBER	10 MISC. DESCRIPTION	11 IDENTIFICATION / SERIAL NUMBER	12 VALUE
--------	--------	--------	-------------	-----------------------------	------------------------	----------------------	-----------------------------------	----------

2. [REDACTED] wouldn't pack Nancy's clothing and ship them to [REDACTED]; she would pack them at a time of her choosing, within the next month.
3. [REDACTED] would not move her mother's dining room set and bedroom set to [REDACTED]; he would store it in the garage allowing time for her brother [REDACTED] to move it.
4. Nancy received a jury duty summons in March 2003 when Nancy was in Las Vegas. [REDACTED] called the courts and told them Nancy had moved to Las Vegas and was no longer a Camarillo resident. Wilson suggested Nancy contact the courts and serve the jury duty to maintain her California residence status.
5. [REDACTED] close the credit card accounts and just leave her with a Discover card, until she was able to get her own credit card.
6. No issue #6 given.

[REDACTED] explained that Nancy was intending to continue to live in the Camarillo house after 3-20-03 because she didn't like their Las Vegas house and her family in Las Vegas was "too overbearing."

[REDACTED] explained that it seemed to him that Nancy wanted access to the Camarillo house throughout the separation period. [REDACTED] said that Nancy was confident that if she was to stay at the Camarillo house, [REDACTED] would move elsewhere.

[REDACTED] said that when he offered his and [REDACTED] support for Nancy to confront [REDACTED] with the 6 issues, she said she knew they were there if she needed them, not telling [REDACTED] when she was going to confront [REDACTED] about these issues. [REDACTED] said that [REDACTED] told him that Nancy was very despondent when he left to have dinner with his mother, because [REDACTED] remembered thinking why was he leaving if she was so despondent. [REDACTED] didn't mention that he and Nancy had talked about any of the 6 issues.

I asked [REDACTED] if there was anything that he thought might help us get a better picture of what was going on with Nancy around the time of her death. [REDACTED] said that Nancy told Wilson that if she

13 DATE / TIME OF REPORT 04-01-03 / 0925	14 REPORTING OFFICER / ID NO / DIV / UNIT Sgt. M. Powers/#1365/Special Services	15 APPROVED BY / ID NO Sgt. Montagna #1047 <i>GM</i>
---------------------------------------------	------------------------------------------------------------------------------------	---------------------------------------------------------

NARRATIVE REPORT VENTURA COUNTY SHERIFF'S DEPARTMENT

Page 10 of 11

Continuation

AGENCY IDENTIFIER CA0560000

1 R.D. 3261	2 BEAT 3C02	3 RB NUMBER 2003-08235
----------------	----------------	---------------------------

4 CODE	5 ITEM	6 QTY.	7 ITEM NAME	8 BRAND / MAKE MANUFACTURER	9 MODEL NAME OR NUMBER	10 MISC. DESCRIPTION	11 IDENTIFICATION / SERIAL NUMBER	12 VALUE
--------	--------	--------	-------------	-----------------------------	------------------------	----------------------	-----------------------------------	----------

wanted to spend more than \$100.00, she had to get approval from [REDACTED] over the phone prior to spending the money.

[REDACTED] said that when he and Nancy went to Wilson's office on 3-3-03, Wilson asked to see a list of Nancy and [REDACTED]'s bank accounts. Nancy told Wilson that [REDACTED] forbid her to show the list of bank accounts to her. Wilson asked Nancy how she expected her to help if she couldn't see the information. Nancy showed them to Wilson after she promised not to tell anyone, "even in your sleep." The two bank accounts showed a total of \$120,000.00 in the accounts. Wilson told Nancy to withdraw a total of \$60,000.00 from the two accounts.

Nancy called [REDACTED] 3-4-03 from [REDACTED] and told him that [REDACTED] had withdrawn all the money from the \$80,000.00 account and placed an account with \$20,000.00 in it in an account she had access to, allowing her to equally split up the bank accounts.

[REDACTED] said that when he and Nancy were in Wilson's office on 3-18-03, [REDACTED] asked Nancy to tell Wilson about the bank accounts. Nancy told Wilson that she went to the bank and found that [REDACTED] had taken \$60,000.00 of \$80,000.00 from one account and she took \$39,000.00 from the other account. [REDACTED] reminded Nancy that he told her the previous week that [REDACTED] closed the account. Nancy admitted lying to [REDACTED] and said she didn't know why she had lied to him. Nancy apologized again for lying to [REDACTED] and [REDACTED] told her that was fine, but not to do it again.

[REDACTED] said that Nancy called him later that afternoon on 3-18-03 around 1600 hours and apologized for lying to him again in a dramatic style, hoping that he would still be her friend. After Nancy's death, [REDACTED] called Wilson making arrangements to have some of the documents that Nancy provided her returned to [REDACTED] through him ([REDACTED]). Wilson commented that Nancy was the meekest person she'd ever seen and wondered if Nancy was on medication when she was in her office.

I asked if there was any discussion about auditing [REDACTED]'s financial records. Wilson noted that using the figures provided to her by Nancy from [REDACTED], [REDACTED]'s expenses dramatically

13 DATE / TIME OF REPORT 04-01-03 / 0925	14 REPORTING OFFICER / ID NO / DIV / UNIT Sgt. M. Powers/#1365/Special Services	15 APPROVED BY / ID NO Sgt. Montagna #1047 <i>Gm</i>
---------------------------------------------	------------------------------------------------------------------------------------	---------------------------------------------------------

NARRATIVE REPORT VENTURA COUNTY SHERIFF'S DEPARTMENT

Page 11 of 11

Continuation

AGENCY IDENTIFIER CA0560000

1 R.D.
3261

2 BEAT
3C02

3 RB NUMBER
2003-08235

4 CODE	5 ITEM	6 QTY.	7 ITEM NAME	8 BRAND / MAKE MANUFACTURER	9 MODEL NAME OR NUMBER	10 MISC. DESCRIPTION	11 IDENTIFICATION / SERIAL NUMBER	12 VALUE
--------	--------	--------	-------------	-----------------------------	------------------------	----------------------	-----------------------------------	----------

exceeded his income, and she suggested Nancy not sign an agreement until they found out what his real income was. Generally, [REDACTED] agreed to take care of the expenses of the [REDACTED] house and give Nancy \$5,000.00 per month alimony for about 20 years.

I asked if there was ever any discussion about forensic audits of their bank accounts. [REDACTED] said that Wilson did propose a forensic examination of the Pearlman's bank accounts. [REDACTED] said Nancy was "deathly afraid" that a forensic exam would reveal some of [REDACTED]'s improper business practices such as [REDACTED]'s personal expenses being charged to the business. Nancy feared that she would also be placed in some sort of liability. [REDACTED] said that when she expressed these issues to Wilson, she (Wilson) agreed that it would not be a good idea to expose wrongdoing by [REDACTED] and endanger Nancy's source of income and the idea was completely dismissed by both Nancy and Wilson. End of interview.

13 DATE / TIME OF REPORT
04-01-03 / 0925

14 REPORTING OFFICER / ID NO / DIV / UNIT
Sgt. M. Powers/#1365/Special Services

15 APPROVED BY / ID NO
Sgt. Montagna #1047 *GM*

NARRATIVE REPORT VENTURA COUNTY SHERIFF'S DEPARTMENT

Page 1 of 2

Continuation

AGENCY IDENTIFIER CA0560000

1 R.D.
3261

2 BEAT
3C02

3 RB NUMBER
2003-08235

4 CODE	5 ITEM	6 QTY.	7 ITEM NAME	8 BRAND / MAKE MANUFACTURER	9 MODEL NAME OR NUMBER	10 MISC. DESCRIPTION	11 IDENTIFICATION / SERIAL NUMBER	12 VALUE
--------	--------	--------	-------------	-----------------------------	------------------------	----------------------	-----------------------------------	----------

- Supplemental Case Cleared
 Gang Domestic Hate Child Abuse Elderly Abuse

Connecting Report Numbers:

Code Section / Description: Dead Body

Reclassify to:

Code: V-1 **Name:** Pearlman, Nancy

4-1-03

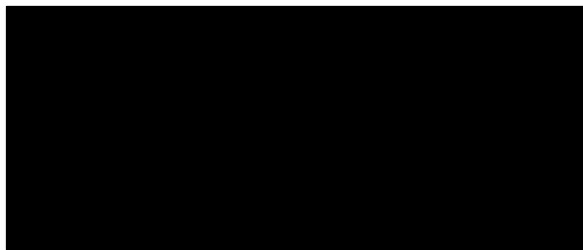

On 4-1-03 at 0756 hours, [redacted]ald [redacted] left me a message on my voice mail, which I recorded. In the message, [redacted]ald stated that he dropped some items off to [redacted] [redacted] yesterday. [redacted] told [redacted]ald that there were two witnesses to the shooting (of Nancy Pearlman) that went to the Federal Bureau of Investigation with a completely different version of events than what he was told.

On 4-1-03 at about 0852, I called [redacted]ald's phone and spoke to him. [redacted]ald said that she saw [redacted] last night briefly while dropping off some documents to him. [redacted]ald said that [redacted] told him that he ([redacted]) was asked not to attend the memorial service for Nancy in [redacted], [redacted]

[redacted]ald said that [redacted] told him as he was walking out, "By the way, you know there were two eyewitnesses at the scene and they've gone to the FBI and said what the police said is absolutely wrong." [redacted]ald said that [redacted] never told him what the witnesses told the FBI or their identities. [redacted]ald said that [redacted] told him that he had just learned about the two witnesses going to the FBI that day, but didn't tell [redacted] how he learned of it.

13 DATE / TIME OF REPORT
04-01-03 / 1049

14 REPORTING OFFICER / ID NO / DIV / UNIT
Sgt. M. Powers/#1365/Special Services

15 APPROVED BY / ID NO
Sgt. Montagna #1047

NARRATIVE REPORT VENTURA COUNTY SHERIFF'S DEPARTMENT

Page 2 of 2

Continuation

AGENCY IDENTIFIER CA0560000

1 R.D.
3261

2 BEAT
3C02

3 RB NUMBER
2003-08235

4 CODE	5 ITEM	6 QTY.	7 ITEM NAME	8 BRAND / MAKE MANUFACTURER	9 MODEL NAME OR NUMBER	10 MISC. DESCRIPTION	11 IDENTIFICATION / SERIAL NUMBER	12 VALUE
--------	--------	--------	-------------	-----------------------------	------------------------	----------------------	-----------------------------------	----------

█████ald said that one time shortly before Nancy's death, he picked her up at her friend's house in Westlake Village. █████ald said Nancy's friend's name is "█████." █████ald said that █████ spoke at Nancy's memorial. █████ald said that he does know where █████'s house is located and has asked █████ for her phone number.

█████ald said that Nancy had another female friend named, "█████," who went with her to █████ after Nancy withdrew the money from her and █████'s bank account. █████ald said that █████ stayed in █████ with Nancy for three days. End of interview.

After hanging up with █████, I called the Ventura FBI office and spoke to Agent Kevin Kelley, giving him a synopsis of what █████ told me. █████ said he would check and call me back. █████ called me back within two hours. █████ said that he checked with the persons who would handle civil rights violation cases in the Ventura and Los Angeles FBI offices. █████ said he was unable to locate any case involving witnesses to the Nancy Pearlman shooting.

13 DATE / TIME OF REPORT
04-01-03 / 1049

14 REPORTING OFFICER / ID NO / DIV / UNIT
Sgt. M. Powers/#1365/Special Services

15 APPROVED BY / ID NO
Sgt. Montagna #1047

NARRATIVE REPORT VENTURA COUNTY SHERIFF'S DEPARTMENT

Page 1 of 7 Continuation

AGENCY IDENTIFIER CA0560000

1 R.D. 3261	2 BEAT 3C02	3 RB NUMBER 2003-08235
----------------	----------------	---------------------------

4 CODE	5 ITEM	6 QTY.	7 ITEM NAME	8 BRAND / MAKE MANUFACTURER	9 MODEL NAME OR NUMBER	10 MISC. DESCRIPTION	11 IDENTIFICATION / SERIAL NUMBER	12 VALUE
--------	--------	--------	-------------	-----------------------------	------------------------	----------------------	-----------------------------------	----------

- Supplemental Case Cleared
 Gang Domestic Hate Child Abuse Elderly Abuse

Connecting Report Numbers:

Code Section / Description: Dead Body

Reclassify to:

Code: V-1 Name: Pearlman, Nancy

After viewing the scene, Sheriff's Chaplain Mondugno, Coroner Investigator [REDACTED] and I drove to the Pearlman's residence. There I was met by [REDACTED] Pearlman, [REDACTED]'s son and [REDACTED] Pearlman. I asked if we could come inside and [REDACTED] Pearlman invited us inside the residence. I asked if there was a place where we could sit. [REDACTED] invited us to sit at the kitchen table. I told [REDACTED] that Nancy was dead. [REDACTED] became very emotional and began crying, exclaiming words of disbelief that she couldn't be dead. [REDACTED] made some phone notifications, one being Nancy's sister [REDACTED], that she had been shot by the police.

I gave [REDACTED] a brief description of what happened, explaining that I only had brief descriptions of what happened from the officers involved and looked at the physical evidence myself for a short period of time. I summarized telling [REDACTED] that the incident appeared to be a suicide by cop, with Nancy pointing a pistol at the Deputy (Senior Deputy Stevens) forcing him to defend himself and shoot her.

Coroner Investigator [REDACTED] spoke to [REDACTED] about when the family could claim the body and how to make funeral arrangements. [REDACTED] and Mondugno left the Pearlman residence.

13 DATE / TIME OF REPORT 03-24-03 / 1626	14 REPORTING OFFICER / ID NO / DIV / UNIT Sgt. M. Powers/#1365/Special Services	15 APPROVED BY / ID NO Sgt. Montagna
---------------------------------------------	------------------------------------------------------------------------------------	-----------------------------------------

NARRATIVE REPORT VENTURA COUNTY SHERIFF'S DEPARTMENT

Page 2 of 7 Continuation

AGENCY IDENTIFIER CA0560000

1 R.D. 3261	2 BEAT 3C02	3 RB NUMBER 2003-08235
----------------	----------------	---------------------------

4	5	6	7	8	9	10	11	12
DE	ITEM	QTY.	ITEM NAME	BRAND / MAKE MANUFACTURER	MODEL NAME OR NUMBER	MISC. DESCRIPTION	IDENTIFICATION / SERIAL NUMBER	VALUE

03-20-03

Tape Recorded Interview of



At about 2250 hours, I began interviewing. [REDACTED] said that he and Nancy had been married for more than 20 years. [REDACTED] said that Nancy had tried twice before to commit suicide and was currently taking the medications Paxil and Ambien prescribed to her. [REDACTED] didn't know the dosages she was taking. [REDACTED] said that she took the Paxil in the mornings and the Ambien at night to sleep according to her psychiatrist (unknown name) at Kaiser Medical Center in Woodland Hills. [REDACTED] didn't know if she had been taking her medication as prescribed. [REDACTED] generally described his and Nancy's relationship as "peaks and valleys" because of Nancy's "genetic depressive" mental illness, according to her first psychiatrist. [REDACTED] said that Nancy's first psychiatrist told him that Nancy would go through the peaks and valleys and nothing would ever change. [REDACTED] said that there were times when everything went fine and other times where nothing seemed to go right.

[REDACTED] said that Nancy first tried suicide around 1975 or 1976 by overdosing on 100 Valium and alcohol (because they were separating). [REDACTED] said that Nancy was taken to Los Angeles County Medical Center and held on a 72-hour (5150 WIC) hold. [REDACTED] said that Nancy seemed to be fine after that episode.

[REDACTED] said that the second time Nancy tried to commit suicide was in 1990 when they were separating. [REDACTED] said that Nancy became anorexic, dropping her weight to 90 pounds. [REDACTED] said Nancy tried to do a couple of things to herself, including taking a hairdryer into a bathtub with her. [REDACTED] took Nancy to her parents and sister. [REDACTED] said Nancy was committed to Charter (Mental Health) Hospital in Las Vegas, NV for 30 days. [REDACTED] said that Nancy once again seemed to be in control of her emotions and begged him to come back to her. [REDACTED] got back together with Nancy.

13 DATE / TIME OF REPORT 03-24-03 / 1626	14 REPORTING OFFICER / ID NO / DIV / UNIT Sgt. M. Powers/#1365/Special Services	15 APPROVED BY / ID NO Sgt. Montagna
---------------------------------------------	------------------------------------------------------------------------------------	-----------------------------------------

NARRATIVE REPORT VENTURA COUNTY SHERIFF'S DEPARTMENT

Page 3 of 7 Continuation

AGENCY IDENTIFIER CA0560000

1 R.D. 3261	2 BEAT 3C02	3 RB NUMBER 2003-08235
----------------	----------------	---------------------------

4 CODE	5 ITEM	6 QTY.	7 ITEM NAME	8 BRAND / MAKE MANUFACTURER	9 MODEL NAME OR NUMBER	10 MISC. DESCRIPTION	11 IDENTIFICATION / SERIAL NUMBER	12 VALUE
--------	--------	--------	-------------	-----------------------------	------------------------	----------------------	-----------------------------------	----------

████████ said that he had separated from Nancy twice before this time. ██████████ said that the reasons for their marital discord were from Nancy and ██████████'s disagreement over how to run the family business. Nancy wanted to pay non-family persons to run the business, reasoning that they would not have to pay them as much as ██████████ was paying his family members. ██████████ told me that he had always wanted to build a family business, ██████████ ██████████ that one day his children could take over. And he showed his family members how to obtain business.

████████ explained in 1996 he and Nancy were involved in a bad car accident that left him disabled. ██████████ said that since that time they lived off his old business receivables and disability insurance policies. ██████████ said that he was able to pursue insurance companies who cheated doctors out of billions of dollars. ██████████ said that he taught his children how collect from the insurance companies and his son now runs the business. ██████████ said that he generally works from home now on a consulting basis. ██████████ said that Nancy was also paid from the business as well. ██████████ said that Nancy always complained about not having enough money. ██████████ said that Nancy saved all of her money, being a very thrifty person.

████████ said that after their business became better, he and Nancy maintained two residences, one in ██████████ where Nancy's relatives lived. ██████████ said that he and Nancy spent equal amounts of time between the two houses.

████████ said that he recently separated from Nancy a third time. ██████████ said that Nancy lived in the ██████████ home during most of the separation period. ██████████ said that Nancy was living at the ██████████ Home by herself, but her relatives visited her frequently. ██████████ said that Nancy commented (today or yesterday) that they had been separated for 49 days. ██████████ said that he and Nancy separated over the same issues as the past two times. ██████████ said that this time he was firmer with Nancy, telling her, "I'm not coming back. We have to go our own ways, because things are not getting better. People ██████████

13 DATE / TIME OF REPORT 03-24-03 / 1626	14 REPORTING OFFICER / ID NO / DIV / UNIT Sgt. M. Powers/#1365/Special Services	15 APPROVED BY / ID NO Sgt. Montagna
---------------------------------------------	------------------------------------------------------------------------------------	-----------------------------------------

NARRATIVE REPORT VENTURA COUNTY SHERIFF'S DEPARTMENT

Page 4 of 7 Continuation

AGENCY IDENTIFIER CA0560000

1 R.D. 3261	2 BEAT 3C02	3 RB NUMBER 2003-08235
----------------	----------------	---------------------------

4 CODE	5 ITEM	6 QTY.	7 ITEM NAME	8 BRAND / MAKE MANUFACTURER	9 MODEL NAME OR NUMBER	10 MISC. DESCRIPTION	11 IDENTIFICATION / SERIAL NUMBER	12 VALUE
--------	--------	--------	-------------	-----------------------------	------------------------	----------------------	-----------------------------------	----------

change. I'm myself. You're yourself, the issues with my kids and the business." ██████ said he just couldn't deal with it and wanted to separate from Nancy.

█████ told me that about 10 -14 days ago, Nancy came to the Camarillo home and stayed there for a couple of days. ██████ said that he normally keeps two pistols under the mattress of his bed. ██████ said that he didn't feel comfortable keeping the guns underneath the mattress with Nancy coming, so he hid them in a Leucasse shoebox inside the walk-in closet atop a shelf. ██████ explained that the box had been there for many years and he didn't believe Nancy would open it and look inside. ██████ said that during Nancy's stay, they talked about the divorce and drafted the divorce settlement agreement. ██████ explained that he checked the box after Nancy left about 7-10 days ago, and found that the Glock pistol was still inside the box, but the Smith and Wesson 9mm (which he believed was) a model 39 was gone. ██████ explained that Nancy had gone through all his bills and documents in the house.

█████ said that the missing Smith and Wesson pistol was registered in his name. ██████ said that he checked around for the missing gun, speaking to a friend of Nancy's ██████ and ██████ whom she had gone to an attorney with about the divorce. ██████ said that ██████ told him that Nancy told him (█████) that she had taken the gun. ██████ said about a week or so ago, he spoke to Nancy on the phone about taking one of the guns. ██████ said that Nancy confirmed she had the gun, but wouldn't tell him where it was. When ██████ asked Nancy the whereabouts of the gun, she told him, "It's in a safe place. (UNINTELLIGIBLE) you'll be able to find it."

█████ said that he went to Europe last week. ██████ said he came back from Europe last night (3-19-03). ██████ said that Nancy was at the Camarillo house and wanted to reconcile their marriage. ██████ said that Nancy told him she wanted to try to change what had been going on. ██████ said that nothing has changed in the past 20 years; they had separated 3 other times. ██████ told Nancy each time they get back together they always have the same problems. ██████ told Nancy he was not going to go back to her this time. ██████ said that they talked about the separation and divorce. ██████ said that Nancy told him she was not going to file for

13 DATE / TIME OF REPORT 03-24-03 / 1626	14 REPORTING OFFICER / ID NO / DIV / UNIT Sgt. M. Powers/#1365/Special Services	15 APPROVED BY / ID NO Sgt. Montagna
---------------------------------------------	------------------------------------------------------------------------------------	-----------------------------------------

NARRATIVE REPORT VENTURA COUNTY SHERIFF'S DEPARTMENT

Page 5 of 7

Continuation

AGENCY IDENTIFIER CA0560000

1 R.D. 3261	2 BEAT 3C02	3 RB NUMBER 2003-08235
----------------	----------------	---------------------------

4 DE	5 ITEM	6 QTY.	7 ITEM NAME	8 BRAND / MAKE MANUFACTURER	9 MODEL NAME OR NUMBER	10 MISC. DESCRIPTION	11 IDENTIFICATION / SERIAL NUMBER	12 VALUE
------	--------	--------	-------------	-----------------------------	------------------------	----------------------	-----------------------------------	----------

divorce, so [REDACTED] said he would file for divorce. [REDACTED] said that he and Nancy had already agreed on a property settlement. [REDACTED] commented that Nancy was going to receive a lot more than if attorneys became involved.

[REDACTED] said that today (3-20-03) between 1500-1700 he and Nancy talked about her taking specific family heirlooms to Las Vegas with her. [REDACTED] told Nancy that she could take what ever she wanted to [REDACTED] that would make her comfortable; they would pack them up this coming weekend and Nancy could take them in a rental truck to [REDACTED]. [REDACTED] said that Nancy didn't have any experience driving the truck, so he offered to drive the truck to [REDACTED] on Saturday (3-22-03), then fly back home. [REDACTED] said that Nancy declined his offer saying that they were not going to do anything until the divorce became final. [REDACTED] told Nancy, "...I'll get everything started next week (begin the divorce proceedings)..." [REDACTED] said that he wanted to finalize everything with Nancy.

[REDACTED] said that he and Nancy talked about their marriage tonight (3-20-03), asking [REDACTED] if there was any way they could get back together. [REDACTED] told Nancy, "There's no way we are going to be able to do this." [REDACTED] said that he offered to be Nancy's best friend and take care of her financially.

[REDACTED] said that Nancy climbed into the bed in the master bedroom, covered herself with the throw depicted in the photo I took on the bedspread, and began shaking. [REDACTED] said that Nancy asked him, "Would you give me one more big hug?" [REDACTED] said that he told her "sure" and gave Nancy a hug. Nancy told [REDACTED], "This will be our last hug." [REDACTED] said that Nancy had talked like that in the past. [REDACTED] told Nancy that he hadn't seen his mother in a week; he was going to take her to dinner and would be back in an hour. [REDACTED] explained that his mother has dementia and he sees her 2-3 times a week. [REDACTED] said that he left his house at about 1715 hours, taking his mother out to dinner at about 1730 hours.

[REDACTED] said that he cut his dinner with his mother short because he was concerned upon reflecting at the different tone in Nancy's voice. [REDACTED] came home and saw the zippered gun

13 DATE / TIME OF REPORT 03-24-03 / 1626	14 REPORTING OFFICER / ID NO / DIV / UNIT Sgt. M. Powers/#1365/Special Services	15 APPROVED BY / ID NO Sgt. Montagna
---------------------------------------------	------------------------------------------------------------------------------------	-----------------------------------------

NARRATIVE REPORT VENTURA COUNTY SHERIFF'S DEPARTMENT

Page 6 of 7

Continuation

AGENCY IDENTIFIER CA0560000

1 R.D.
3261

2 BEAT
3C02

3 RB NUMBER
2003-08235

4 CODE	5 ITEM	6 QTY.	7 ITEM NAME	8 BRAND / MAKE MANUFACTURER	9 MODEL NAME OR NUMBER	10 MISC. DESCRIPTION	11 IDENTIFICATION / SERIAL NUMBER	12 VALUE
--------	--------	--------	-------------	-----------------------------	------------------------	----------------------	-----------------------------------	----------

case that had contained the Smith and Wesson pistol that Nancy had taken about 10-14 days prior. [REDACTED] showed me the gun case as he found it. I saw the gun case was laying open, exposing the white fleece lining on the right side of the bed in the master bedroom (where Nancy was lying when [REDACTED] left). Lying in the center of the gun case was a Verizon cell phone that [REDACTED] identified as belonging to Nancy. [REDACTED] told me, "That is Nancy's weird way of saying good-bye and what was going to happen." I asked [REDACTED] to explain his interpretation of the gun case and cell phone. [REDACTED] said Nancy was showing him she had the gun and leaving her phone so he couldn't communicate with her to try and stop her (from committing suicide).

[REDACTED] said upon seeing the cell phone and gun, he dialed 9-1-1 because he thought Nancy was going to "go do something to hurt herself." [REDACTED] said that he didn't actually believe that Nancy was going to shoot herself. I asked why. [REDACTED] explained that Nancy was a meticulously neat and clean person who could never make a mess, "...not on her own." [REDACTED] said that Nancy had talked to him previously, "Oh, I would never shoot myself, because I wouldn't want to leave a mess, especially in the house."

I asked [REDACTED] if Nancy was familiar with guns. [REDACTED] said that he and Nancy would go shooting generally once every other year. [REDACTED] said that Nancy was employed as a clerk in the Federal Bureau of Investigation (for a couple of years) and used the shooting range there. [REDACTED] said that Nancy preferred revolvers and hated semi-automatics. [REDACTED] said that he does not own any revolvers. [REDACTED] said that in addition to the Smith and Wesson 9mm pistol, he owns a Glock 40 caliber pistol, which is the gun that Nancy didn't take from the Camarillo house and a Glock 9mm pistol, which is kept in the [REDACTED] home for Nancy's protection.

[REDACTED] called Nancy's sister [REDACTED] [REDACTED] in [REDACTED] to see if Nancy had talked to her. [REDACTED] said that [REDACTED] told him that Nancy had called her and told her take all of her jewelry and give all her cash to her mother and father. [REDACTED] said that he interpreted Nancy's call to [REDACTED] as a "good-bye to [REDACTED]," basically as Nancy's verbal will to [REDACTED].

13 DATE / TIME OF REPORT
03-24-03 / 1626

14 REPORTING OFFICER / ID NO / DIV / UNIT
Sgt. M. Powers/#1365/Special Services

15 APPROVED BY / ID NO
Sgt. Montagna

NARRATIVE REPORT VENTURA COUNTY SHERIFF'S DEPARTMENT

Page 7 of 7 Continuation

AGENCY IDENTIFIER CA0560000

1 R.D. 3261	2 BEAT 3C02	3 RB NUMBER 2003-08235
----------------	----------------	---------------------------

4 CODE	5 ITEM	6 QTY.	7 ITEM NAME	8 BRAND / MAKE MANUFACTURER	9 MODEL NAME OR NUMBER	10 MISC. DESCRIPTION	11 IDENTIFICATION / SERIAL NUMBER	12 VALUE
--------	--------	--------	-------------	-----------------------------	------------------------	----------------------	-----------------------------------	----------

█████ said that Nancy had a written will. █████ wasn't aware of anybody else Nancy called that evening.

█████ said that he was not aware of Nancy calling relatives the previous two times she tried to commit suicide and leaving any wills or saying good-byes. █████ agreed with my interpretation that this time sounded "much more serious" than the previous times and had gone much further this time than in previous times. I asked if Nancy wanted █████ to give her a hug, or had him do anything that final the two previous times she tried to commit suicide. █████ said, "Not that I remember."

I asked █████ if there was anything else he wanted to add that would help us in this investigation. █████ suggested that we check Nancy's records at Kaiser Hospital. █████ explained that he and Nancy had both recently filed for long-term disability. █████ said that Nancy was turned down for some (unknown to █████) psychiatric issues in the Kaiser files.

█████ said that Nancy is right handed. █████ said that Nancy shoots right handed, demonstrating to me that Nancy would hold the gun in her right hand and use her left hand palm up to stabilize the butt of the gun. End of interview 2330 hours.

On 3-24-03, pursuant to a request by █████ █████, I went into the █████ that Nancy Pearlman was driving on 3-20-03. I removed the following three items from the █████

1. █████
2. CA placard registration card
3. One key ring with 7 keys LA work out, Ralph's Club and Smith's fresh values plastic cards on them.

I was unable to locate a █████ pair of Maui Jim sunglasses that █████ said were located in the center console. I delivered the above property to █████'s home on 3-24-03.

13 DATE / TIME OF REPORT 03-24-03 / 1626	14 REPORTING OFFICER / ID NO / DIV / UNIT Sgt. M. Powers/#1365/Special Services	15 APPROVED BY / ID NO Sgt. Montagna
---------------------------------------------	------------------------------------------------------------------------------------	-----------------------------------------

**ADDITIONAL NAMES
REPORT**

VENTURA COUNTY SHERIFF'S DEPARTMENT
AGENCY IDENTIFIER CA0560000

Page 1 of 1

1 RB NUMBER
03-08235

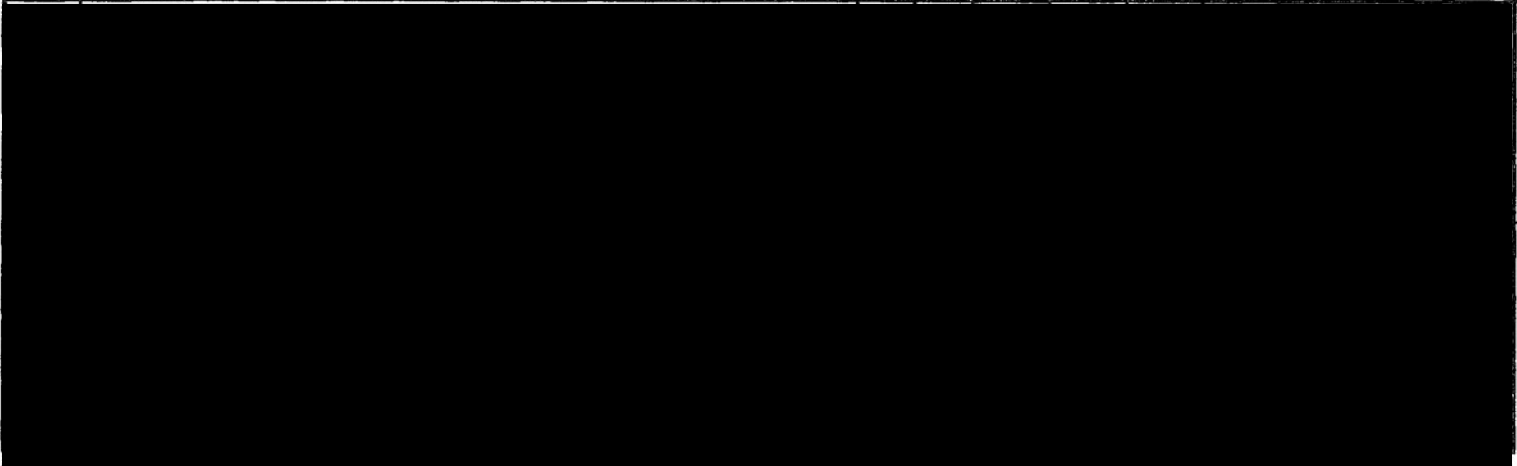

25	26	NAME (Last, First, Middle, Gen.) / FIRM NAME	AKA / Moniker	27	RACE	28	SEX	29	HT	30	WT	31	HAIR	32	EYES	33	DOB	34	AGE				
35 RESIDENCE ADDRESS / (<input type="checkbox"/> Same as Box # _____)														CITY		STATE		ZIP		36 RESIDENCE PHONE ()			
37 BUSINESS / SCHOOL NAME ADDRESS / (<input type="checkbox"/> Same as Box # _____)														CITY		STATE		ZIP		38 BUSINESS PHONE ()			
39 OCCUPATION (<input type="checkbox"/> STUDENT)				40 DAYS OFF			41 WORK HRS.			42 INTERPRETER			43 OPERATOR'S LIC. NO. / STATE										
44 VEH. LIC. NO. / STATE			45 VEH. COLOR /			YEAR /		MAKE /		MODEL /		BODY STYLE		46 OTHER CHARACTERISTICS / VIN NO.									
47 COMMENTS:																							

48	49	NAME (Last, First, Middle, Gen.) / FIRM NAME	AKA / Moniker	50	RACE	51	SEX	52	HT	53	WT	54	HAIR	55	EYES	56	DOB	57	AGE				
58 RESIDENCE ADDRESS / (<input type="checkbox"/> Same as Box # _____)														CITY		STATE		ZIP		59 RESIDENCE PHONE ()			
60 BUSINESS / SCHOOL NAME ADDRESS / (<input type="checkbox"/> Same as Box # _____)														CITY		STATE		ZIP		61 BUSINESS PHONE ()			
62 OCCUPATION (<input type="checkbox"/> STUDENT)				63 DAYS OFF			64 WORK HRS.			65 INTERPRETER			66 OPERATOR'S LIC. NO. / STATE										
67 VEH. LIC. NO. / STATE			68 VEH. COLOR /			YEAR /		MAKE /		MODEL /		BODY STYLE		69 OTHER CHARACTERISTICS / VIN NO.									
70 COMMENTS:																							

71	72	NAME (Last, First, Middle, Gen.) / FIRM NAME	AKA / Moniker	73	RACE	74	SEX	75	HT	76	WT	77	HAIR	78	EYES	79	DOB	80	AGE				
81 RESIDENCE ADDRESS / (<input type="checkbox"/> Same as Box # _____)														CITY		STATE		ZIP		82 RESIDENCE PHONE ()			
83 BUSINESS / SCHOOL NAME ADDRESS / (<input type="checkbox"/> Same as Box # _____)														CITY		STATE		ZIP		84 BUSINESS PHONE ()			
85 OCCUPATION (<input type="checkbox"/> STUDENT)				86 DAYS OFF			87 WORK HRS.			88 INTERPRETER			89 OPERATOR'S LIC. NO. / STATE										
90 VEH. LIC. NO. / STATE			91 VEH. COLOR /			YEAR /		MAKE /		MODEL /		BODY STYLE		92 OTHER CHARACTERISTICS / VIN NO.									
93 COMMENTS:																							

94 DATE / TIME OF REPORT <u>3-24-03/1200</u>					95 REPORTING OFFICER / ID NO. / DIV. / UNIT <u>M. POWERS 1368 SPL 8UCS</u>					96 APPROVED BY / ID NO.				
-------------------------------------------------	--	--	--	--	-------------------------------------------------------------------------------	--	--	--	--	-------------------------	--	--	--	--

1514 AM KENNEL MANN - CLOSERS IN INTERIOR BEHAVIOR

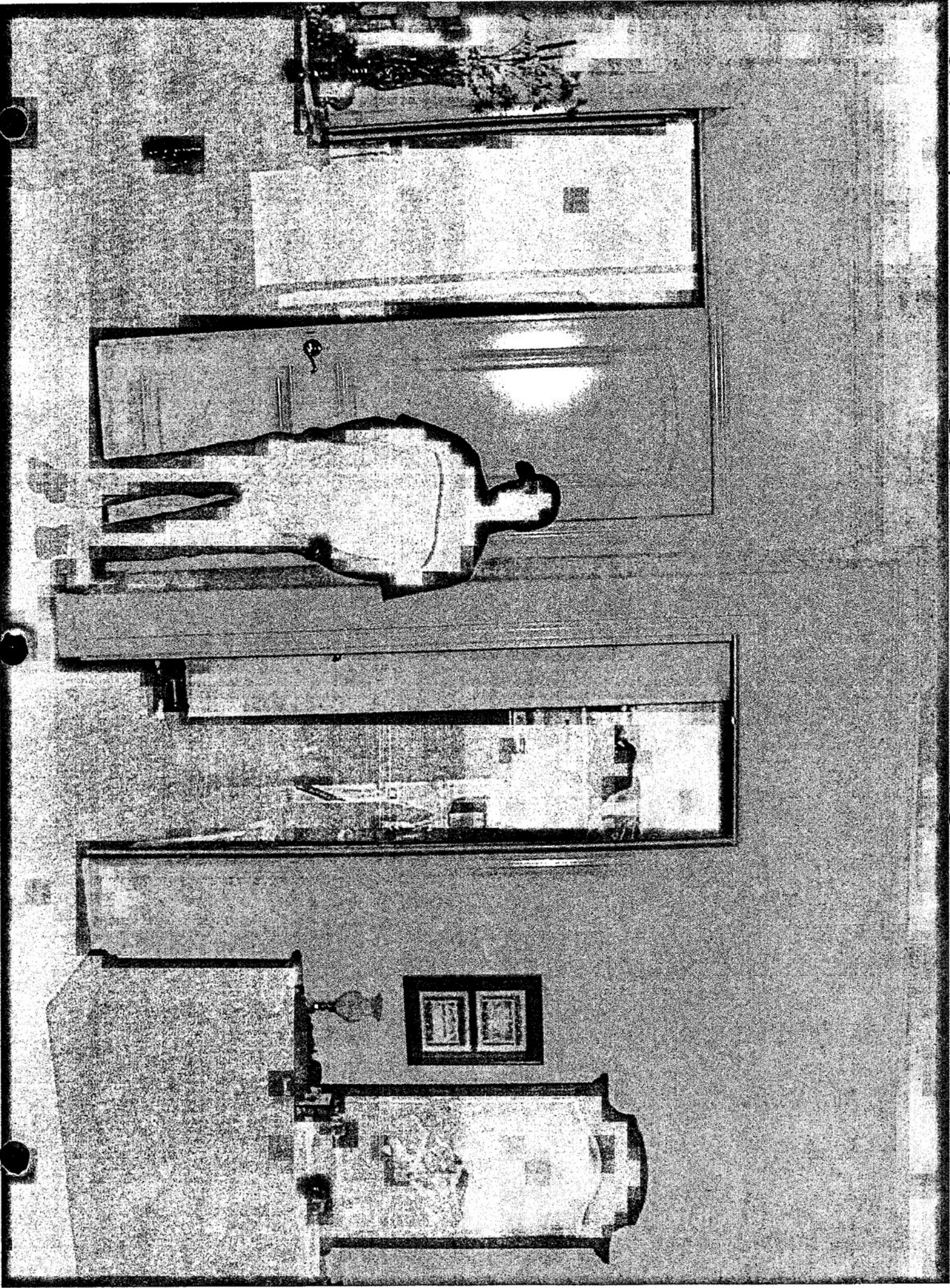

00524 ON LEFT WALLS ON WALLS 2/1/72

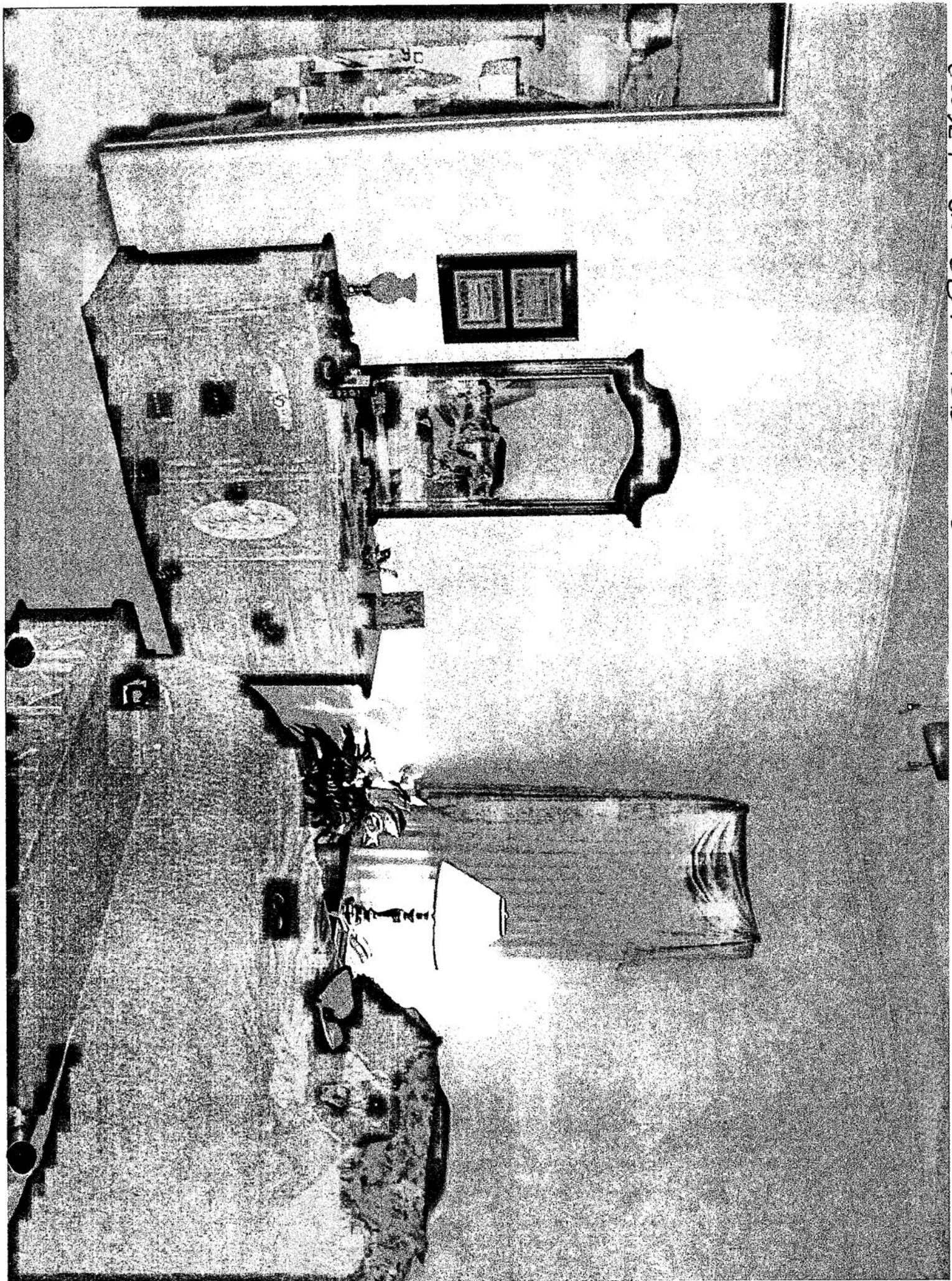

BUCKLE UP WITH MARY ON JUNE 10, 1967

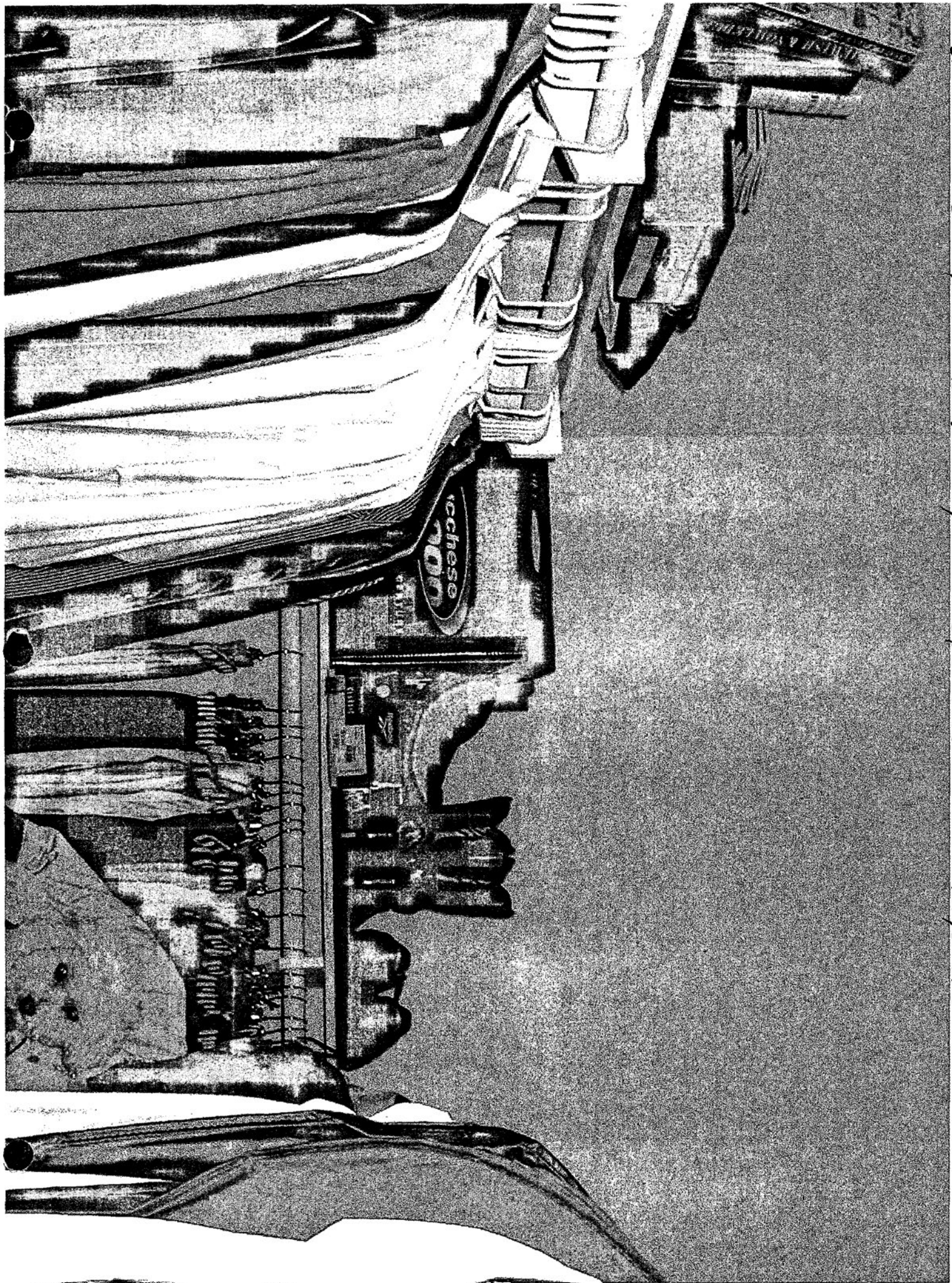

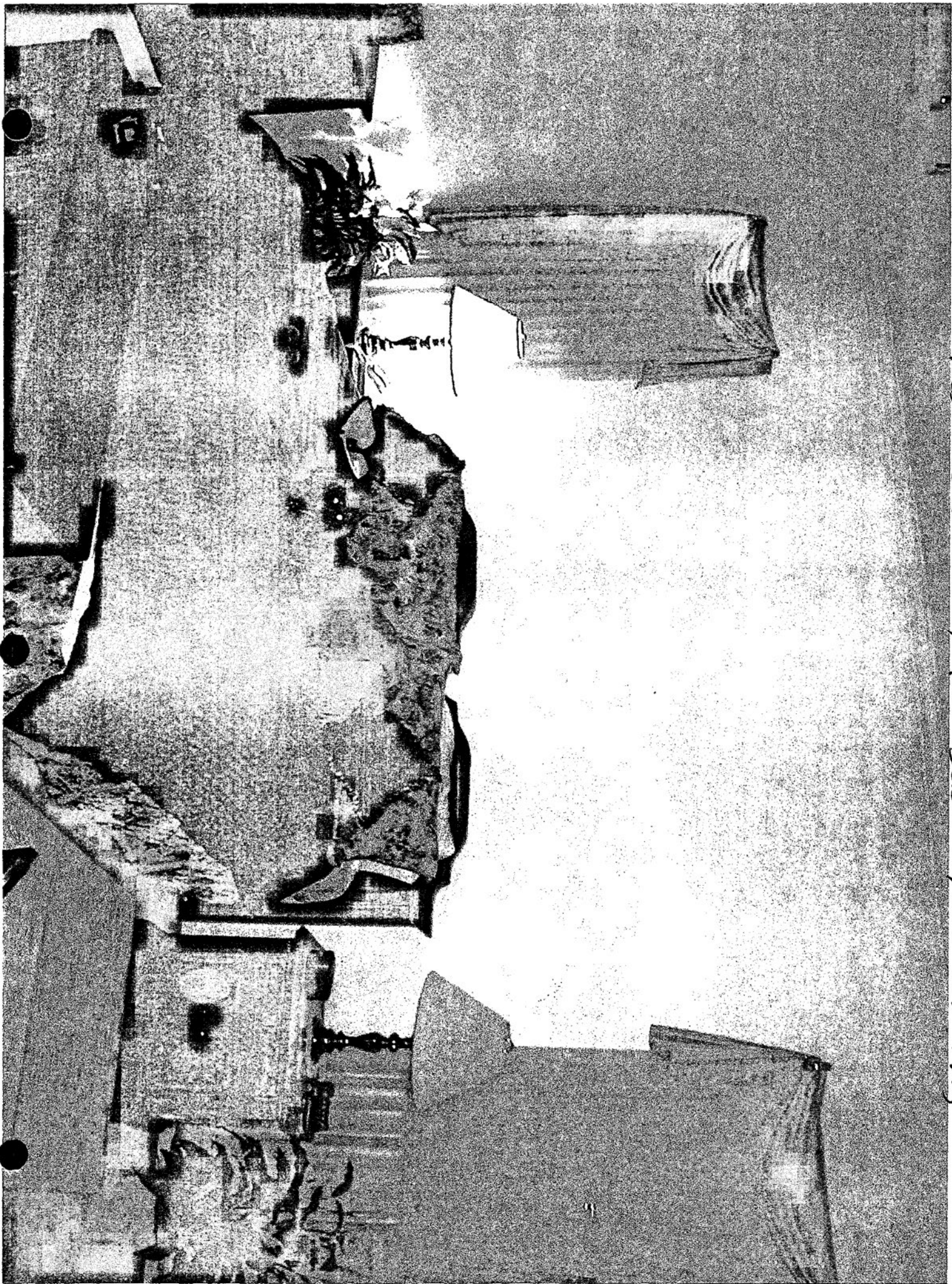

1950 WILSONE NANCY THE IDEEN CYRUS 11 17 1950

1560 WHITE HAWKY INTS 1565N CHYINE MI 110



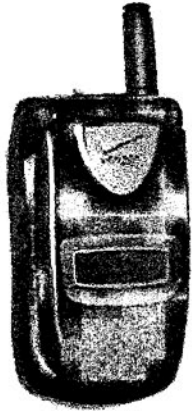

SUN USE FOR SPW 110111 & NINEYS USE 110111 110111 110111



Decedent Name: Nancy Jean Pearlman
Also Known As:
Residence: [REDACTED]
Place of Death: Point Mugu Parking Lot
Manner of Death: Homicide
Cause of Death: gunshot wound of head
Due to:
Due to:
Due to:
Other Significant Conditions: none

Date of Birth: [REDACTED]
Age: [REDACTED]
Death Date: 03/20/2003
Death Time: 00:00:00
Property: Yes
Autopsy by: Dr. O'Halloran
Investigator: Mike [REDACTED]

SUMMARY OF INVESTIGATION

On 3/20/03, at 1950, Captain Bob Le May of the Ventura County Sheriff's Department reported the death of [REDACTED] Nancy Pearlman. The decedent's husband had contacted the Sheriff's Department and reported that the decedent had a handgun in her possession and that she was suicidal. He requested their assistance in locating the decedent. Officers in two Sheriff's cars, found the decedent parked in the parking lot just north of Point Mugu. Officers attempted to communicate her, but she drove away from them. While pursuing the vehicle, the Officers attempted to position their cars in a manner to prevent the decedent from departing the parking lot. Having deterred the decedent's speed and direction, the closest Officer was in close proximity to the decedent's vehicle. He was able to see that the decedent was pointing a handgun at him. He drew his handgun and fired two shots at the decedent. A shot was also fired into each of the two tires on the right side of the decedent's vehicle. The decedent's vehicle rolled for approximately 150 feet and came to a stop adjacent to the northbound lane of the Pacific Coast Highway. 911 was called and Ventura County Firemen responded to the location. The decedent was pronounced at 1931. I told Captain Le May that I would respond to the scene.

Upon my arrival, Sergeant Ernie Montagna confirmed information provided by Captain Le May. He said that the shots had been fired at approximately 1921 and that the decedent had been pronounced at 1931. He showed me where the decedent's SUV had come to a stop. The engine of the SUV was still running and the headlights were on. The doors of the SUV were open and the decedent was behind the wheel of the vehicle. The safety belt/shoulder strap of the vehicle was still fastened around the decedent.

The decedent was a red-haired, blue-eyed, Caucasian female. She had a bullet entry wound on the left side of her head. It was located on the outer periphery of her left eye. There was no exit wound. Crepitation could be felt upon palpation below the left eye. Blood had drained from the decedent's

Signature: _____

Mike [REDACTED] Deputy Medical Examiner



nose, mouth, right ear, and the wound. There was no rigor or lividity. There were no conjunctival petechiae.

The decedent's black purse was lying on the passenger side of the front seat. Inside the purse was a navy blue wallet. The picture on the driver's license, within the wallet, confirmed the decedent to be Nancy Jean Pearlman.

A black 9mm Smith and Wesson handgun was lying on the seat of the SUV. It was immediately adjacent to the decedent's left thigh. The top of the barrel of the gun was lying against the seat of the SUV with the opening of the barrel pointed toward the front of the SUV. The handle of the gun was facing upward and was leaning against the decedent's left arm. I was later told that the handgun had not been fired.

Clothing worn by the decedent included a blue shirt, white pants, and black shoes.

Jewelry worn by the decedent included two yellow metal rings, a pair of yellow metal earrings, a yellow and white metal watch, two yellow metal neck chains, and a yellow metal anklet.

Sergeant Montagna said that the protocols for an officer involved shooting would require a more extended period of time before removal of the decedent's body could be facilitated. He told me that the decedent's husband had not yet been informed of the decedent's death. I told him that I would go to the husband's residence and inform him of the death. Sergeant Mike Powers, Chaplain Larry [REDACTED], and myself drove to [REDACTED] residence. We explained that Nancy Pearlman was dead and provided as much information as we could regarding the circumstances surrounding the death. [REDACTED] told us that he and Nancy were in the process of getting a divorce. He said that Nancy had been living for a period of time in [REDACTED]. She had returned a couple of days ago and they were discussing the divorce. [REDACTED] said that they had been married for more than 28 years. Much of that time had been very stressful due to the decedent's battle with depression. He said that in 1975 the decedent had attempted to commit suicide by taking an overdose of pills. Again in 1995, she attempted to kill herself by getting into a bathtub with her electric hair dryer. Much of the time between those two dates she had battled anorexia. [REDACTED] said that at one time the decedent weighed only 89 pounds. [REDACTED] said that he attended counseling with the decedent. He also said that the decedent was taking the medications Paxil and Ambien for her depression. He said that earlier today he had been talking to her and she said that she would leave their relationship. She told him that he would not see her again. He said that he did not interpret this to mean that she intended to do harm to herself. He left the house a little later to take care of some errands. When he returned, he found that she had taken his 9mm Smith & Wesson handgun. She had left the gun sheath open on their bed with her cellular phone on top of it. [REDACTED] said that he had hidden the gun from her on previous occasions due to fear that she might use it to harm herself. [REDACTED]

Signature: _____

Mike [REDACTED] Deputy Medical Examiner



██████████ called the Sheriff's Department and informed them of what Nancy had ██████. He told them that Nancy was suicidal and requested their assistance in finding her.

We explained to ██████████ that we did not currently have all of the facts surrounding the circumstances associated with the death. I explained that the investigation at the scene of the incident would continue for several more hours, and that all of this information would eventually be available to him. I told him that Nancy's body would be transported to the Medical Examiner's morgue and that an autopsy would be ██████ to determine the cause of death. I explained how Nancy's personal belongings could be collected and suggested that he might begin consideration of his choices for a funeral home. I told him that I would call him with the autopsy results.

Upon return to the location of the shooting, I inspected the SUV that was driven by the decedent. The ██████████ I later found that the vehicle had been leased by ██████████. All of the windows of the SUV were closed. There were two bullet holes in the window of the driver's door. The window was still in place, but was shattered. There was a large circular hole in the window of the front passenger's door. There was a small hole at the periphery of this hole that might have been the cause for the larger hole. Although much of the window was still in place, it was also shattered. Initial speculation was that one of the two shots fired into the SUV hit the decedent. The other shot missed the decedent and passed out of the SUV through the window of the front passenger door. The tires on the right side of the SUV were flat. Sergeant Montagna said that one of the Sheriff's Officers involved in the initial incident had shot the tires to prevent the driver from leaving the area. There was a dent in the left rear corner of the SUV. It was believed that this was a consequence of the maneuvering ██████ to prevent the driver from leaving the parking area. The SUV was impounded by the Ventura County Sheriff's Department.

I took photos of the decedent and the vehicles.

Jewelry and personal property of the decedent were inventoried and stored for collection by next-of-kin.

As per my request, CMA personnel transported the decedent to the Medical Examiner's morgue.

On 3/21/03, this case was reviewed with the Chief Medical Examiner, Dr. Ronald O'Halloran. Dr. O'Halloran completed an autopsy and determined the cause of death to be gunshot wound of head. The manner of death was homicide.

██████████ was informed of the autopsy results and has selected Pierce Brothers funeral home in Camarillo.

Signature: 

Mike ██████ Deputy Medical Examiner

MEDICAL EXAMINER-CORONER

COUNTY OF VENTURA

AUTOPSY REPORT

PEARLMAN, NANCY

601-03

PERFORMED BY: Ronald L. O'Halloran, M.D.
PERFORMED AT: Ventura County Medical Examiner's Office
DATE: March 21, 2003
TIME: 8:45 a.m.

CAUSE OF DEATH: GUNSHOT WOUND OF HEAD

MANNER OF DEATH: HOMICIDE

ANATOMIC DIAGNOSES:

- I. Gunshot wound of head, with:
 - A. Entrance – left side of face, distant range
 - B. Direction – front-to-back, left-to-right and upward
 - C. Glass shatter lacerations and abrasions of left side of face, left side of neck, left shoulder and dorsum of right hand
 - D. Slug – recovered from dura in midline of occiput
 - E. Associated injuries – skull fractures; subdural and subarachnoid hemorrhage; perforation of left temporal lobe, left occipital lobe and left cerebellum; aspirated blood in lungs

GENERAL DESCRIPTION:

When first viewed the body is in a blue body bag sealed with #023773. Inside the body bag the body is wrapped in a pale green sheet. This unembalmed Caucasian female appears consistent with the stated age of 56 years, measures 63½" and weighs 111 pounds clothed.

CLOTHING:

1. A slip-on black shoe is on the left foot and a matching shoe is inside the sheet with the body.
2. White denim pants are about the waist and legs, fastened in the front with a button and the zipper is closed. No belt is present. Bloodstains are on the waist portion of the garment. Pieces of side window broken glass are on the front of the pants, in the groin area. All of the pockets are empty.
3. White brief-style underpants are about the waist. The upper front portion is soaked with blood.
4. A short sleeve blue sweater is on the upper torso. The front buttons are all buttoned. Bloodstains are on the left front panel and on the left front shoulder.
5. A beige-colored bra is in place around the chest and fastened in the front. It has bloodstains on both bra cups.
6. A yellow metal chain anklet is around the left ankle.
7. A thin yellow metal belly chain piece of jewelry is around the waist.
8. A "Concord" brand wristwatch is around the left wrist and is functioning.
9. A yellow metal ring is on the right thumb.
10. A yellow metal ring with clear stones and a central red stone is on the left ring finger.
11. A yellow metal necklace, with a pair of swans as a pendent, is around the neck. It has some blood on it.
12. In each pierced earlobe is a yellow metal flower-patterned earring.

EXTERNAL EXAMINATION:

The scalp hair is dyed brown and is gray at the roots, measuring up to 5" in length. The corneae are clear, the irides are gray-blue, and the conjunctivae are pale and free of petechiae. Blood is in the nostrils. The lips are free of injuries. The dentition is natural. No injuries are present in the mouth. The external ears are normally formed and the earlobes are pierced. The neck is normally formed. Injuries of the face and neck will be described below. Blood is streaked across the left side of the face, left neck, between the breasts and onto the abdominal area from the gunshot wound.

The chest is symmetrical and the breasts are free of palpable masses. The abdomen is not distended. No scars are visible on the abdomen. The external genitalia are normally formed and free of inflammation or trauma. The pubic hair is partially shaved on the top and on the sides.

The upper extremities are normally formed, without scars visible on the wrists or in the antecubital fossae. Small injuries on the right hand will be described below. The hands are clean and the fingernails are artificial, painted light pink and intact.

The lower extremities are normally formed. Three brownish contusions are on the anterior aspect of the left upper thigh, with faded yellowish margins. They vary from ¼" to ½" in diameter. A similar faded yellowish-green contusion is on the anterior lower left abdomen, over the iliac crest, measuring ½". No ankle edema is present. The feet are clean.

The back and anus are normally formed. The anus is not dilated and no inflammation is present. No injuries are on the back.

Rigor is complete, and lividity is red-purple, posterior and partially fixed.

GUNSHOT WOUND:

Entrance – A gunshot wound of entrance is in the left side of the face, on the lateral canthus of the left eye. It is located 5" below the top of the head and 2 ½" to the left of the bridge of the nose. It consists of a roughly rounded cutaneous perforation that measures 3/8" in diameter. It has a slightly eccentric rim of abrasion that is widest on the lateral side, where it measures 1/8" in maximal width. Slight tearing is present on the upper extremity, with a ¼" tear and a 1/8" tear on the inferior margin. No soot is visible on the adjacent skin. No gunpowder stippling is present. Associated with the entry wound is a dense pattern of superficial cutaneous abrasion, consistent with shattered glass abrasions, similar to the side window glass scattered on the surfaces of the clothing. These abrasions and superficial penetrating lacerations vary from pinpoint up to 1/8" in diameter. Several of the larger defects contain small fragments of clear glass. This glass spray abrasion pattern extends from the gunshot wound down to the left clavicle, a distance of 7" vertically and has a horizontal spread extending from the middle of the left ear to the chin, a distance of 6". None of this glass shatter abrasion pattern is above the level of the eyebrow. The spray of

glass abrasion pattern is fairly well demarcated and ends at the base of the left neck, but approximately ten similar superficial abrasions and lacerations are on the dorsum of the left shoulder. In addition, approximately five glass abrasion and superficial penetration injuries are on the dorsum of the right hand and on the ventral right wrist. The injuries on the dorsum of the hand are at the base of the thumb and index finger.

Slug – A deformed gray metal slug with a copper jacket is recovered from the inside of the occipital skull, just external to the dura, at a point exactly in the sagittal midline, 3" below the top of the head and 3" above the inion. It lies just deep to an outwardly displaced skull fracture in the occipital midline. The nose of the slug is flattened and deformed and the base is relatively intact. The base of the slug measures .38" in a relatively nondeformed area.

Direction – The gunshot wound track proceeds from front-to-back, slightly left-to-right and slightly upward at an angle approximately 30 degrees above the horizontal plane and approximately 30 degrees from the sagittal plane.

Course – After penetrating the skin of the left face by the left eye, the gunshot wound perforates the temporalis muscle area and enters the skull through the left sphenoid bone, causing a 1" diameter inwardly displaced fracture. The gunshot wound then perforates the left temporal lobe of the brain and lacerates the inferior portion of the left basal ganglia. It then proceeds through the medial portion of the left occipital lobe and lacerates the lateral portion of the left cerebellum. It then terminates where the slug was recovered. Associated with the gunshot wound is an outwardly displaced 2" occipital skull fracture in the midline and linear nondisplaced fractures that extend superiorly and to the left through the left occipital bone and into the left parietal bone. A linear fracture extends through the inferior posterior portion of the left sphenoid bone. Fractures extend through the left petrous ridge. A small amount of mostly posterior subarachnoid and subdural hemorrhage is also present.

Associated injuries – Associated with the gunshot wound is blood in the mouth and nose, and aspirated blood in the bronchi and deep into the lungs bilaterally.

INTERNAL EXAMINATION:

The subcutaneous fat of the abdomen measures $\frac{3}{4}$ ". The thoracic and abdominal organs are in normal relationships. The pleural, pericardial and peritoneal cavities are free of hemorrhage or fluid accumulation.

SYSTEMS REVIEW:

CARDIOVASCULAR: The heart weighs 190 grams, and has a smooth epicardium and pericardium, without adhesions. The coronary arteries arise from the aorta in the usual fashion and are distributed normally, with the right side being dominant.

There is no atherosclerotic narrowing of any of the coronary arteries. The cardiac chambers and cardiac valves are of normal size and free of focal lesions. The aorta and its major branches arise and are distributed normally.

NECK: The soft tissues and cartilagenous tissues of the neck, larynx and cervical vertebral column are free of evidence of injury. The larynx is unobstructed and a small amount of aspirated blood is in the laryngeal and tracheal lumen.

RESPIRATORY: The combined weight of the lungs is 840 grams. Both lungs have smooth pleural surfaces, without adhesions. Both lungs have slight to moderate subpleural anthracotic pigment deposits. Both are well expanded and pink superiorly and anteriorly, and both have a moderate amount of aspirated blood in a spotty pattern bilaterally, especially in the lower lobes from aspiration. Blood is in the bronchi. The pulmonary arteries are free of thromboemboli. Sectioning the lungs reveals no focal lesions.

GASTROINTESTINAL: The esophagus, stomach, small and large intestines and appendix are intact and free of focal lesions. The stomach contains an estimated 20 cc. of mostly mucoid fluid, with a few pieces of clear vegetable matter resembling onion. No pill fragments and no other food is seen. The gastric and duodenal mucosa is not hyperemic or ulcerated.

LIVER, GALLBLADDER, & PANCREAS: The liver weighs 1000 grams and has a smooth capsule and a uniform red-brown lobular parenchyma, without focal lesions. The gallbladder contains an estimated 30 cc. of bile, without stones. The cystic and common bile ducts are patent. The pancreas is of normal size, shape and consistency.

SPLEEN & LYMPH NODES: The spleen weighs 90 grams and has a smooth capsule and a uniform red-purple, moderately firm parenchyma. Regional lymph nodes are not enlarged.

GENITOURINARY: The combined weight of the kidneys is 170 grams. Both kidneys have capsules that strip with ease from an underlying red-brown cortex of normal thickness. The renal pelves and ureters are not dilated. The urinary bladder contains an estimated 40 cc. of clear yellow urine.

The uterus, ovaries and fallopian tubes are normally formed and small. The endometrium is thin and nonhemorrhagic.

ENDOCRINE: The pituitary, thyroid and adrenal glands are unremarkable.

MUSCULOSKELETAL: The axial and appendicular skeletal system and adjacent musculature are free of evidence of injury, except for the skull fractures from the gunshot wound described previously.

HEAD & CENTRAL NERVOUS SYSTEM: The scalp is reflected in the usual fashion, revealing left scalp hemorrhage overlying the linear skull fracture in the left occipital and parietal region. Skull fractures from the gunshot wound were described previously.

The brain weighs 1200 grams and has a normal pattern of gyri and sulci, with a gunshot wound track through the left side, described previously. Subdural and subarachnoid hemorrhage is associated. Multiple coronal sections of the cerebral hemispheres, brainstem and cerebellum reveal no other focal lesions.

TOXICOLOGY: A sample of blood from the aorta, urine and the recovered gastric contents are retained.

HISTOLOGY: Sections of major organs are retained.

PHOTOGRAPHY: Photographs are taken by myself and by the sheriff's department.

DISPOSITION OF EVIDENCE:

The subject's clothing, the sheet wrapped around the body and the body bag, a DNA card, gunshot residue kit, fingerprints and the recovered slug are released to the sheriff's department.

RLO/jc



Ronald L. O'Halloran, M.D.
Medical Examiner-Coroner

CORONER # 601-03

OFFICE OF THE MEDICAL EXAMINER

NAME NANCY PEARLMAN

SO CASE NO. 03-8235

AGE 56 RACE W SEX F

DATE 3-21-03

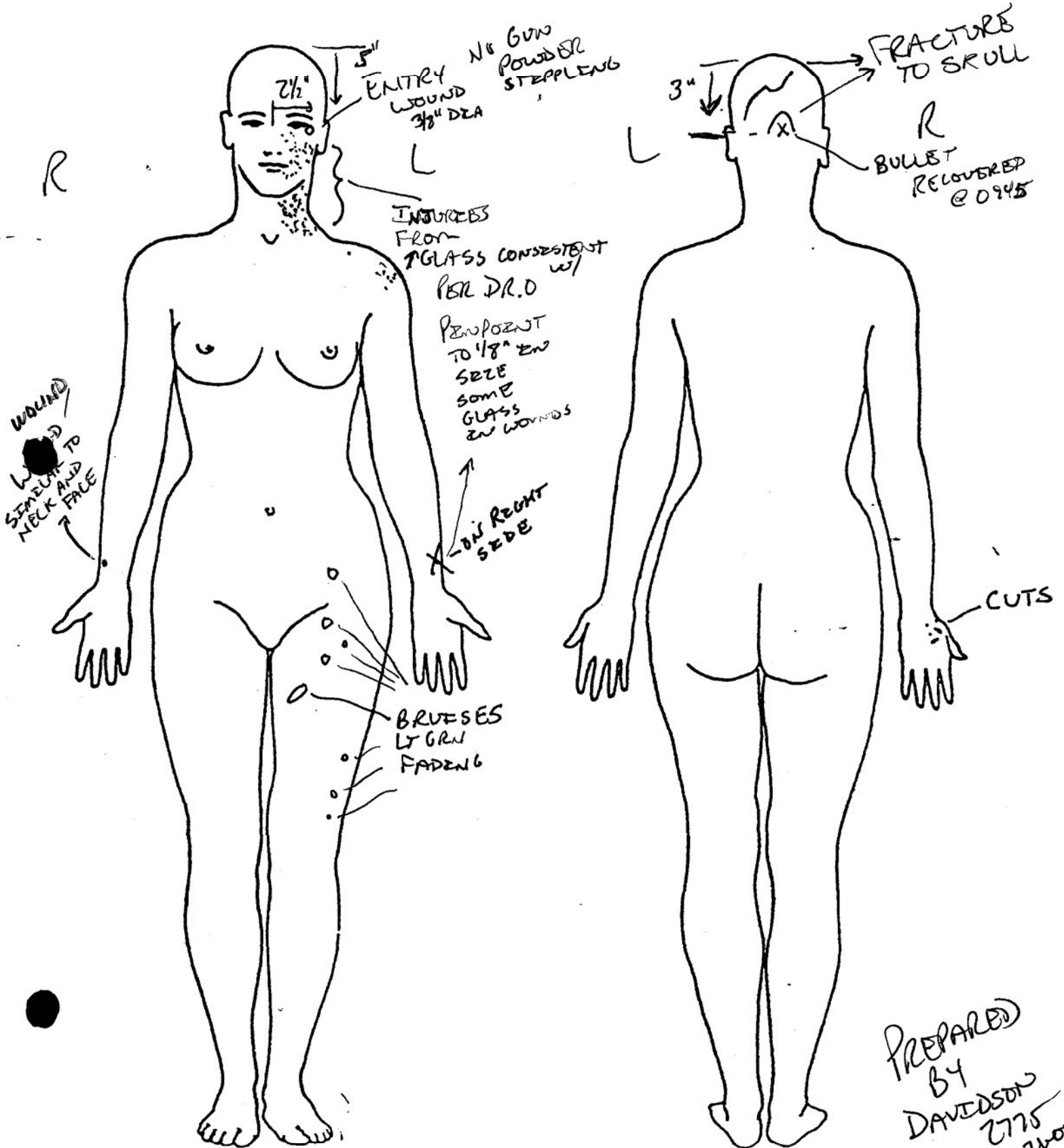

PREPARED BY DAVIDSON 2775 2/20/03

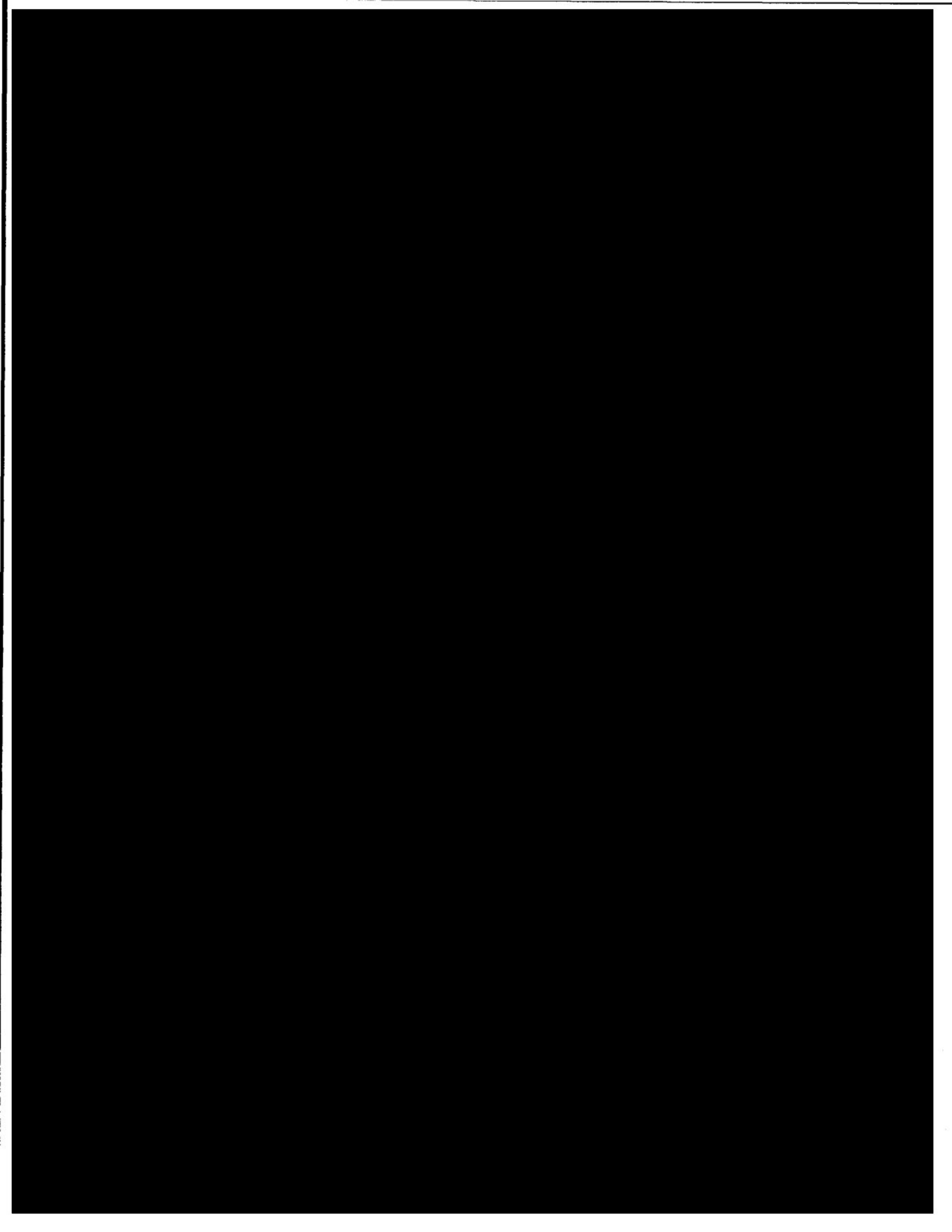

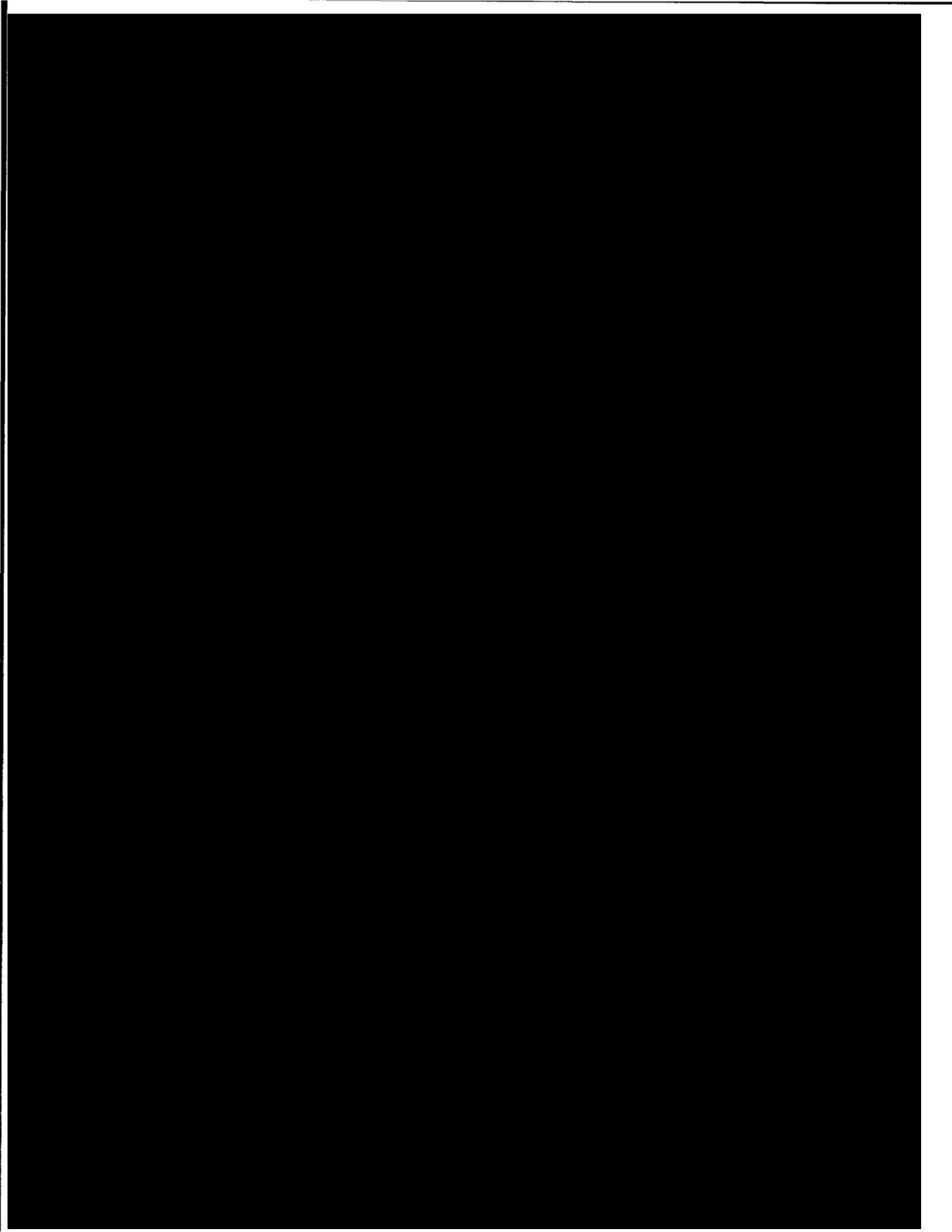



OFFICE OF
MEDICAL EXAMINER-CORONER
3291 LOMA VISTA ROAD
VENTURA, CA 93003
(805) 641-4400 Fax (805) 641-4410

RONALD L. O'HALLORAN, M.D.
Chief Medical Examiner
JANICE G. FRANK, M.D.
Assistant Medical Examiner

COUNTY OF VENTURA

FACSIMILE COVER SHEET

MEDICAL EXAMINER-CORONER

COUNTY OF VENTURA

PLEASE DELIVER THE FOLLOWING DOCUMENTS TO:

NAME: Montagna
OFFICE: VC50
FROM: Jaye
TIME: 2:30
SUBJECT: Pearlman tof

The number of pages being transmitted, including this cover sheet
are 4.

If you do not receive all the pages, please call Jaye at
(805) 641-4400

NARRATIVE REPORT VENTURA COUNTY SHERIFF'S DEPARTMENT

Page 1 of 5 Continuation

AGENCY IDENTIFIER CA0560000

1 R.D.	2 BEAT	3 RB NUMBER
3261	8235	03-8235

4 CODE	5 ITEM	6 QTY.	7 ITEM NAME	8 BRAND / MAKE MANUFACTURER	9 MODEL NAME OR NUMBER	10 MISC. DESCRIPTION	11 IDENTIFICATION / SERIAL NUMBER	12 VALUE
--------	--------	--------	-------------	-----------------------------	------------------------	----------------------	-----------------------------------	----------

Supplemental Case Closed

Gang Domestic Hate Child Abuse Elderly Abuse

Connecting Report Numbers: Medical Examiners Case #601-03

Code Section / Description: Officer Involved Shooting

Code: P1 Name: Pearlman, Nancy [REDACTED]

Autopsy Report

Background

On 7-20-03 at approximately 1922 hours, a shooting occurred at Mugu Rock in the South Coast area of Ventura County. The shooting involved two Sheriff's Deputies and the deceased, Nancy Pearlman. Pearlman's body was taken by the Medical Examiner's Office and an autopsy was scheduled for the following morning.

Report

On 3-21-03 at approximately 0830 hours, I was in my office at the Major Crimes Bureau. I was contacted by Detective Rubright, who told me that my assistance was requested at the autopsy of Nancy Pearlman. I was aware that Ms. Pearlman was shot during an incident with Sheriff's Deputies the previous evening. I responded to the Medical Examiner's Office and met with Sgt. Lorenzen who was also attending the autopsy.

I arrived at 0850 hours, the autopsy had not yet begun however the body bag had been opened and unzipped. Sgt. Lorenzen told me Dr. O'Halloran had opened the body bag at 0847 hours. The seal tag on the body bag was #023773. Present for the Autopsy was Dr. O'Halloran, Sgt. Lorenzen, Field Evidence Technician (FET) [REDACTED], Medical Examiner Assistant [REDACTED] and myself. Dr. Frank was also in the room conducting a separate, unrelated autopsy.

13 DATE / TIME OF REPORT	14 REPORTING OFFICER / ID NO / DIV / UNIT	15 APPROVED BY / ID NO
03/25/03 10:05 AM	Detective R. Davidson #2775/Special Services	<i>S. Montefino</i> 1047

NARRATIVE REPORT VENTURA COUNTY SHERIFF'S DEPARTMENT

Page 2 of 5 Continuation

AGENCY IDENTIFIER CA0560000

1 R.D.	2 BEAT	3 RB NUMBER
3261	8235	03-8235

4 CODE	5 ITEM	6 QTY.	7 ITEM NAME	8 BRAND / MAKE MANUFACTURER	9 MODEL NAME OR NUMBER	10 MISC. DESCRIPTION	11 IDENTIFICATION / SERIAL NUMBER	12 VALUE
--------	--------	--------	-------------	-----------------------------	------------------------	----------------------	-----------------------------------	----------

I began noting my observations of the autopsy. I noted the following.

The body was wrapped in a white sheet. Blood had seeped through and soaked into parts of the sheet. When the sheet was removed from the body, I saw that the body was that of a middle aged Caucasian woman. She appeared to be approximately 5'3" tall with a very slender build weighing what I approximated as 110 pounds. She had light brown hair.

She was wearing the following clothing:

- Shirt/Top:** Blue button front short-sleeved sweater with bloodstains and streaks on the front.
- Bra:** Tan, nylon or similar material, front closure.
- Pants:** White jeans, zipper front, nothing in pockets, no belt. Bloodstains in the torso area and glass fragments on the outer surface of the pants.
- Underwear:** White cotton, lace on sides.
- Socks:** None.
- Shoes:** Black, slip on style. Right shoe was off and lying near foot in body bag.
- Jewelry:**
 - Earrings:** Yellow metal bow shaped earrings, one on each ear. Blood dried on left earring.
 - Necklace:** Yellow metal with two swans facing each other. A large amount of blood encrusted on swan pendant area of necklace.
 - Watch:** Left wrist. Yellow and white metal, "Concord" brand. The watch was functioning.
 - Ring:** Right Hand, Thumb. Yellow metal ring with no stones.
Left Hand, Ring finger. Yellow metal ring with red center stone and clear side stones.
 - Belly chain:** Yellow metal chain around waist.
 - Ankle chain:** Yellow metal chain around left ankle.

The body was undressed and the clothing was collected by FET [redacted] Medical Examiner [redacted] removed and collected the jewelry. FET [redacted] collected Gun Shot Residue samples from both hands, and later booked these samples as evidence. The body was washed to remove dried/caked on blood and a visual examination of the body was then conducted. We observed the following. Note: I also diagrammed

13 DATE / TIME OF REPORT	14 REPORTING OFFICER / ID NO / DIV / UNIT	15 APPROVED BY / ID NO
03/25/03 10:05 AM	Detective R. Davidson#2775/Special Services	S. Montefur 1047

NARRATIVE REPORT VENTURA COUNTY SHERIFF'S DEPARTMENT

Page 3 of 5 Continuation

AGENCY IDENTIFIER CA0560000

1 R.D.	2 BEAT	3 RB NUMBER
3261	8235	03-8235

4 CODE	5 ITEM	6 QTY.	7 ITEM NAME	8 BRAND / MAKE MANUFACTURER	9 MODEL NAME OR NUMBER	10 MISC. DESCRIPTION	11 IDENTIFICATION / SERIAL NUMBER	12 VALUE
--------	--------	--------	-------------	-----------------------------	------------------------	----------------------	-----------------------------------	----------

my observations on a preprinted form with the front and back of a female body displayed. That form was given to Sgt. Montagna and Detective Rivera, the case agents, for inclusion in their case file.

Visual Observations

Head:

- 1 - A wound consistent with an entry wound was readily visible at the lower outside corner of the left eye. The wound was approximately 5" down from the top of the head and 2 1/2" from the bridge of the nose. The wound itself was approximately 3/8" in diameter. There was no gunpowder stippling present.
- 2 - There were numerous pinpoint to 1/8" wounds peppered across the left side of the face. The wounds extended from just below the left eyebrow to the chin. There were small shards of glass embedded in some of the wounds. According to Dr. O'Halloran, these wounds were consistent with injuries typically received from flying glass when a window shatters.

Neck:

- 1 - The wounds noted in #2 above continued onto the neck. They were also on the left side and extended to the base of the neck where the neck flares to the shoulder.

Shoulders:

- 1 - On the outside (Dorsal) of the left shoulder, we noted additional wounds that appeared to be from the shattered glass.

Arms/hands:

- 1 - On the back of the right hand near the base of the index finger and thumb there were several wounds which were also consistent with the glass injuries observed on the face, neck and shoulder.
- 2 - There was also a single wound, which had the same appearance as the other wounds, on the inside of the right arm near the base of the thumb but slightly up the arm toward the forearm area (see diagram for illustration).

Chest:

No injuries, scars, tattoos or other notable conditions present.

13 DATE / TIME OF REPORT 03/25/03 10:05 AM	14 REPORTING OFFICER / ID NO / DIV / UNIT Detective R. Davidson#2775/Special Services	15 APPROVED BY / ID NO <i>[Signature]</i> 1047
-----------------------------------------------	------------------------------------------------------------------------------------------	---------------------------------------------------

NARRATIVE REPORT VENTURA COUNTY SHERIFF'S DEPARTMENT

Page 4 of 5 Continuation

AGENCY IDENTIFIER CA0560000

1 R.D.	2 BEAT	3 RB NUMBER
3261	8235	03-8235

4 CODE	5 ITEM	6 QTY.	7 ITEM NAME	8 BRAND / MAKE MANUFACTURER	9 MODEL NAME OR NUMBER	10 MISC. DESCRIPTION	11 IDENTIFICATION / SERIAL NUMBER	12 VALUE
--------	--------	--------	-------------	-----------------------------	------------------------	----------------------	-----------------------------------	----------

Back:

No injures, scares or tattoos were observed. Lividity was present.

Torso/Groin:

We saw eight (8) light green faded bruises/contusions on the left side of the torso, extending from just below the visible hipbone down to the area just above the left knee. According to Dr. O'Halloran, these injuries were old. Most of the bruises were very small, approximately 1/2" in diameter, with the exception of one which was longer (2") and about 5/8" wide. This bruise was on the left thigh on the inside of the leg.

Legs/Feet:

No injures, scares, tattoos or other notable conditions present, other than the bruising noted on the left leg/groin area.

Dr. O'Halloran then began the internal examination of the body. The internal organs of the chest and abdomen were removed and examined. Dr. O'Halloran found no signs of injury, trauma or other unusual conditions (medical or otherwise) present. Dr. O'Halloran noted that the stomach was virtually empty.

The examination continued to the head/skull. The skin of the scalp was cut and pulled back to reveal the skull. Two very evident fractures could be seen on the back of the head. The first was a flap of bone in a half circle shape. The fractured area was pushed out from the skull. This injury was located to the back of the skull on the midline and approximately 3" from the top of the skull. Dr. O'Halloran observed that this injury appears to have been the result of the bullet striking the back of the head. He probed the area immediately behind the bone and located the bullet. The bullet was removed, measured and collected by FET [REDACTED]. The second fracture was on the left rear portion of the skull. It generally extended in an up/down direction and stopped behind the left ear.

Medical Examiner Assistant [REDACTED] removed the skull cap (bone) exposing the brain. Dr. O'Halloran removed the brain and examined it. He showed us the track of the bullet through the brain. The path of the bullet was in a straight line from the area of the left eye orbit to the back of the brain (occipital lobe). I

13 DATE / TIME OF REPORT 03/25/03 10:05 AM	14 REPORTING OFFICER / ID NO / DIV / UNIT Detective R. Davidson#2775/Special Services	15 APPROVED BY / ID NO <i>S. Montagna</i> 1017
-----------------------------------------------	------------------------------------------------------------------------------------------	---------------------------------------------------

NARRATIVE REPORT VENTURA COUNTY SHERIFF'S DEPARTMENT

Page 5 of 5 Continuation

AGENCY IDENTIFIER CA0560000

1 R.D.	2 BEAT	3 RB NUMBER
3261	8235	03-8235

4 CODE	5 ITEM	6 QTY.	7 ITEM NAME	8 BRAND / MAKE MANUFACTURER	9 MODEL NAME OR NUMBER	10 MISC. DESCRIPTION	11 IDENTIFICATION / SERIAL NUMBER	12 VALUE
--------	--------	--------	-------------	-----------------------------	------------------------	----------------------	-----------------------------------	----------

asked Dr. O'Halloran if it appeared that the bullet traveled anywhere else in the brain. Dr. O'Halloran said that based on the path he was observing, the bullet went only in the straight line he described and nowhere else.

Dr. O'Halloran then placed a metal probe through the entry wound to the back of the head where the bullet was found in order to illustrate the path of the bullet. This was photographed by both Dr. O'Halloran and FET [REDACTED].

After completing his examination of the brain, Dr. O'Halloran told us the cause of death was a gunshot wound to the head and the manner of death was being shot by a police officer with a handgun.

The autopsy was concluded. FET [REDACTED] collected the evidence items retrieved during the autopsy. Sgt. Lorenzen and I left the room and returned to our office.

End of report.

13 DATE / TIME OF REPORT	14 REPORTING OFFICER / ID NO / DIV / UNIT	15 APPROVED BY / ID NO
03/25/03 10:05 AM	Detective R. Davidson#2775/Special Services	<i>E. Montoya</i> 1047

NARRATIVE REPORT VENTURA COUNTY SHERIFF'S DEPARTMENT

Page 1 of 4 Continuation AGENCY IDENTIFIER CA0560000

1 R.D. 3270	2 BEAT 3C2	3 RB NUMBER 03-8235
----------------	---------------	------------------------

4 CODE	5 ITEM	6 QTY.	7 ITEM NAME	8 BRAND / MAKE MANUFACTURER	9 MODEL NAME OR NUMBER	10 MISC. DESCRIPTION	11 IDENTIFICATION / SERIAL NUMBER	12 VALUE
--------	--------	--------	-------------	-----------------------------	------------------------	----------------------	-----------------------------------	----------

Supplemental Case Closed

Gang Domestic Hate Child Abuse Elderly Abuse

Connecting Report Numbers:

Code Section / Description: Officer Involved Shooting

Code: S Name: Pearlman, Nancy

EXCHANGE OF HANDGUNS

On 3-20-03, I was present while Sgt. B. Macedo exchanged the handguns that were used by Deputies Stephens and Cerio during this incident. The exchange took place outside, on the side of the road, next to a parked car. Stephens and Cerio had the handguns they used during this incident secured in their holsters.

Field Evidence Technician E. [REDACTED] took custody of the following handguns and related equipment and booked the items as evidence.

Deputy Stephens

Handgun: [REDACTED]
[REDACTED] containing one (1) magazine loaded with ten (10) 9mm rounds and one (1) 9mm round in the chamber.

Additional Ammunition: Two (2) additional magazines collected from the deputy's ammunition pouch attached to his gun belt. Each magazine contained fifteen (15) 9mm rounds.

13 DATE / TIME OF REPORT 4/16/2003 / 8:38 AM	14 REPORTING OFFICER / ID NO / DIV / UNIT J. Rivera / 2696 / WC / Special Services	15 APPROVED BY / ID NO <i>E. Morstein</i> 1007
-------------------------------------------------	---------------------------------------------------------------------------------------	---------------------------------------------------

NARRATIVE REPORT VENTURA COUNTY SHERIFF'S DEPARTMENT

Page 2 of 4

Continuation

AGENCY IDENTIFIER CA0560000

1 R.D. 3270	2 BEAT 3C2	3 RB NUMBER 03-8235
----------------	---------------	------------------------

4 CODE	5 ITEM	6 QTY.	7 ITEM NAME	8 BRAND / MAKE MANUFACTURER	9 MODEL NAME OR NUMBER	10 MISC. DESCRIPTION	11 IDENTIFICATION / SERIAL NUMBER	12 VALUE
--------	--------	--------	-------------	-----------------------------	------------------------	----------------------	-----------------------------------	----------

Deputy Cerio

Handgun: [REDACTED]

[REDACTED] containing one (1) magazine with twelve (12) 9mm rounds, and one (1) 9mm round in the chamber.

Additional Ammunition: Two (2) additional magazines collected from the deputy's ammunition pouch attached to his gun belt. Each magazine contained fifteen (15) 9mm rounds.

Two (2) additional magazines collected from a hanging seat organizer in Deputy Cerio's assigned patrol unit, numbered "3415." Each of the magazines contained fifteen (15) 9mm rounds.

Additional information: The ammunition collected from Deputy Stephens and Cerio were "Speer" brand ammunition.

During the exchange of weapons and collection of ammunition, Sr. Deputy D. Place asked Deputy Cerio if he knew how many rounds he had in the magazine that was inside of his handgun. Deputy Cerio told him he had a total of twelve (12) rounds and one in the chamber.

Cerio explained that prior to the exchange, his attorney instructed him to remove the magazine from his handgun and count the remaining rounds. Cerio was then

13 DATE / TIME OF REPORT 4/16/2003 / 8:38 AM	14 REPORTING OFFICER / ID NO / DIV / UNIT J. Rivera / 2696 / WC / Special Services	15 APPROVED BY / ID NO S. Montagna 1047
-------------------------------------------------	---------------------------------------------------------------------------------------	--------------------------------------------

NARRATIVE REPORT VENTURA COUNTY SHERIFF'S DEPARTMENT

Page 3 of 4 Continuation AGENCY IDENTIFIER CA0560000

1 R.D. 3270	2 BEAT 3C2	3 RB NUMBER 03-8235
----------------	---------------	------------------------

4 CODE	5 ITEM	6 QTY.	7 ITEM NAME	8 BRAND / MAKE MANUFACTURER	9 MODEL NAME OR NUMBER	10 MISC. DESCRIPTION	11 IDENTIFICATION / SERIAL NUMBER	12 VALUE
--------	--------	--------	-------------	-----------------------------	------------------------	----------------------	-----------------------------------	----------

instructed by his attorney to place the rounds back in the magazine and reinsert the magazine in his handgun.

Cerio said he normally carries his handgun with one (1) round chambered and fifteen (15) rounds in the magazine that is inserted in his handgun. He also carries fifteen (15) rounds in each of the two magazines he carries on his gun belt.

I asked Deputy Stephens the same question regarding the number of rounds in his magazine. He told me that he also counted the remaining rounds in the magazine of his handgun at the direction of his attorney. He also replaced the rounds back in the magazine and reinserted the magazine in his handgun.

Deputy Stephens told me that he normally carries his handgun with one (1) in the chamber and fourteen (14) rounds in the magazine inserted in his handgun. He said he has fifteen (15) rounds loaded in each of the two (2) extra magazines he carries on his gun belt.

Field Evidence Technician E. [REDACTED] documented the serial numbers from the handguns he collected from Deputy Stephens and Cerio. He also counted and documented the number of rounds remaining in the magazines of those handguns as well as the extra magazines.

13 DATE / TIME OF REPORT 4/16/2003 / 8:38 AM	14 REPORTING OFFICER / ID NO / DIV / UNIT J. Rivera / 2696 / WC / Special Services	15 APPROVED BY / ID NO <i>S. Montoya</i> / 1147
-------------------------------------------------	---------------------------------------------------------------------------------------	----------------------------------------------------

NARRATIVE REPORT VENTURA COUNTY SHERIFF'S DEPARTMENT

Page 4 of 4

W Continuation

AGENCY IDENTIFIER CA0560000

1 R.D. 3270	2 BEAT 3C2	3 RB NUMBER 03-8235
----------------	---------------	------------------------

4 CODE	5 ITEM	6 QTY.	7 ITEM NAME	8 BRAND / MAKE MANUFACTURER	9 MODEL NAME OR NUMBER	10 MISC. DESCRIPTION	11 IDENTIFICATION / SERIAL NUMBER	12 VALUE
--------	--------	--------	-------------	-----------------------------	------------------------	----------------------	-----------------------------------	----------

Prior to collecting the handguns, I watched Deputy Stephens and Cerio as they locked back the slides of their handguns and removed the chambered round. The handgun and round was then given to [REDACTED] as evidence.

Sgt. Macedo documented identifying information for the two (2) handguns collected and the two (2) handguns that were issued to replace them.

At the conclusion of the exchange, I asked Deputy Stephens and Cerio whether they had any additional handguns that they carried as a backup. Each told me that they did not carry any additional handguns.

13 DATE / TIME OF REPORT 4/16/2003 / 8:38 AM	14 REPORTING OFFICER / ID NO / DIV / UNIT J. Rivera / 2696 / WC / Special Services	15 APPROVED BY / ID NO <i>E. Montoya</i> 1047
-------------------------------------------------	---------------------------------------------------------------------------------------	--------------------------------------------------

PROPERTY / EVIDENCE REPORT

VENTURA COUNTY SHERIFF'S DEPARTMENT

AGENCY IDENTIFIER CA0560000

CONNECTING REPORT NUMBERS		2 R.D. 3262	3 BEAT 3C2	4 RB NUMBER 03-08235
---------------------------	--	----------------	---------------	--------------------------------

5 PROPERTY TYPE: <input checked="" type="checkbox"/> EVIDENCE <input type="checkbox"/> FOUND <input type="checkbox"/> SAFEKEEPING	6 <input type="checkbox"/> Misdemeanor <input type="checkbox"/> Felony	7 DATE OF INCIDENT 3-20-2003
8 ORIGINAL INCIDENT / OFFENSE OFFICER INVOLVED SHOOTING	9 LOCATION OF INCIDENT (STREET ADDRESS AND CITY) MUGU BEACH MALIBU	

CODE: V - Victim S - Suspect A - Arrestee F - Finder O - Owner R - Reporting Party (Use Same Codes in Property Affiliation Box)

CODE 10 V	11 NAME (Last, First, Middle, Gen.) / FIRM NAME PEARLMAN, NANCY	AKA / Moniker	BUSINESS PHONE () ----
--------------	---------------------------------------------------------------------------	---------------	----------------------------

16 RESIDENCE ADDRESS / (<input type="checkbox"/> Same as Box# _____)	CITY	RESIDENCE PHONE (---) ----
------------------------------------------------------------------------	------	---------------------------------

CODE 18	19 NAME (Last, First, Middle, Gen.) / FIRM NAME	AKA / Moniker	RACE 20	SEX 21	22 DOB	23 BUSINESS PHONE ()
---------	-------------------------------------------------	---------------	---------	--------	--------	--------------------------

24 RESIDENCE ADDRESS / (<input type="checkbox"/> Same as Box# _____)	CITY	STATE	ZIP	25 RESIDENCE PHONE ()
------------------------------------------------------------------------	------	-------	-----	---------------------------

CODE 26	27 NAME (Last, First, Middle, Gen.) / FIRM NAME	AKA / Moniker	RACE 28	SEX 29	30 DOB	31 BUSINESS PHONE ()
---------	-------------------------------------------------	---------------	---------	--------	--------	--------------------------

32 RESIDENCE ADDRESS / (<input type="checkbox"/> Same as Box# _____)	CITY	STATE	ZIP	33 RESIDENCE PHONE ()
------------------------------------------------------------------------	------	-------	-----	---------------------------

34 **NARRATIVE**

SEE NARRATIVE ON PAGE FIVE

SEE DIAGRAMS ON PAGES SIX - EIGHT

35 PROPERTY / EVIDENCE INFORMATION

LOCATION BOOKED: <input checked="" type="checkbox"/> Crime Lab <input type="checkbox"/> E.C. <input type="checkbox"/>	SEARCH WARRANT? <input type="checkbox"/> Yes <input type="checkbox"/> No	FINDER WISHES TO CLAIM? <input type="checkbox"/> Yes <input type="checkbox"/> No
-----------------------------------------------------------------------------------------------------------------------	--------------------------------------------------------------------------	----------------------------------------------------------------------------------

36 PROPERTY CLASSIFICATION CODE	PROPERTY CODES
E - EVIDENCE SK-SAFEKEEPING RC - RECOVERED PROPERTY FP - FOUND PROPERTY	A - CURRENCY / NOTES D - VEHICLE B - JEWELRY / PRECIOUS METALS E - OFFICE EQUIPMENT C - CLOTHING / FURS F - ELECTRONIC EQUIPMENT G - FIREARMS H - HOUSEHOLD GOODS J - LIVESTOCK I - CONSUMABLE GOODS K - MISCELLANEOUS

E/K	ITEM # 1	QTY 1	ITEM NAME TURN SIGNAL COVER	MAKE ----	MODEL / CALIBER ----	ID / SERIAL NUMBER PHOTO MARKER #1
-----	-------------	----------	--------------------------------	--------------	-------------------------	---------------------------------------

PROP.AFFIL ---	ADDITIONAL INFORMATION COLLECTED FROM PAVED ROAD AT SCENE					
-------------------	--------------------------------------------------------------	--	--	--	--	--

E/K	ITEM # 2	QTY 7	ITEM NAME CASINGS	MAKE SPEER	MODEL / CALIBER 9 mm	ID / SERIAL NUMBER PHOTO MARKERS #4, #6 - #11
-----	-------------	----------	----------------------	---------------	-------------------------	--------------------------------------------------

PROP.AFFIL ---	ADDITIONAL INFORMATION COLLECTED FROM SCENE					
-------------------	------------------------------------------------	--	--	--	--	--

E/K	ITEM # 3	QTY 1	ITEM NAME GLASS FRAGMENTS	MAKE ----	MODEL / CALIBER ----	ID / SERIAL NUMBER PHOTO MARKER #5
-----	-------------	----------	------------------------------	--------------	-------------------------	---------------------------------------

PROP.AFFIL ---	ADDITIONAL INFORMATION COLLECTED FROM SCENE					
-------------------	------------------------------------------------	--	--	--	--	--

DATE AND TIME OF REPORT 4-8-2003 / 1600	38 REPORTING OFFICER / ID NO. / DIV / UNIT E. [REDACTED] / 3832 / SPEC. SERV. / B.I.	39 APPROVED BY / ID NO. [Signature] 1282
--------------------------------------------	-----------------------------------------------------------------------------------------	---------------------------------------------

COPIES TO DET / MC NARC GANG / SED STATS Press DOJ COURT OTHER

PROPERTY / EVIDENCE REPORT

VENTURA COUNTY SHERIFF'S DEPARTMENT

AGENCY IDENTIFIER CA0560000

Page 2 of 8

41 RB NUMBER
03-08235

PROPERTY CLASSIFICATION CODE

E - EVIDENCE
SK - SAFEKEEPING
RC - RECOVERED PROPERTY
FP - FOUND PROPERTY

PROPERTY CODES

A - CURRENCY/NOTES
B - JEWELRY/PRECIOUS METALS
C - CLOTHING/FURS
D - VEHICLE
E - OFFICE EQUIPMENT
F - ELECTRONIC EQUIPMENT
G - FIREARMS
H - HOUSEHOLD GOODS
I - CONSUMABLE GOODS
J - LIVESTOCK
K - MISCELLANEOUS

PROF.AFFIL --- ADDITIONAL INFORMATION
COLLECTED FROM VICTIM IN VEHICLE ***WITH BLOOD***

CODE	ITEM #	QTY	ITEM NAME	MAKE	MODEL / CALIBER	ID / SERIAL NUMBER
E K	5	1	MAGAZINE WITH AMMO	WIN LUGER	9mm	12+1 ROUNDS

PROF.AFFIL --- ADDITIONAL INFORMATION
REMOVED FROM VICTIM'S WEAPON ***WITH BLOOD***

CODE	ITEM #	QTY	ITEM NAME	MAKE	MODEL / CALIBER	ID / SERIAL NUMBER
E K	6	1	PHOTO CD	----	----	----

PROF.AFFIL --- ADDITIONAL INFORMATION
CREATED FROM DIGITAL IMAGES ON DEPUTY CERIO'S CAMERA

CODE	ITEM #	QTY	ITEM NAME	MAKE	MODEL / CALIBER	ID / SERIAL NUMBER
E K	7	1	VIDEO TAPE	SONY	HI-8 / 120	----

PROF.AFFIL --- ADDITIONAL INFORMATION
VIDEO OF SCENE

CODE	ITEM #	QTY	ITEM NAME	MAKE	MODEL / CALIBER	ID / SERIAL NUMBER
E F	8	1	TAPE RECORDER	SONY	----	----

PROF.AFFIL --- ADDITIONAL INFORMATION
COLLECTED FROM CERIO #3415

PROF.AFFIL --- ADDITIONAL INFORMATION
COLLECTED FROM DEPUTY CERIO #3415

PROF.AFFIL --- ADDITIONAL INFORMATION
COLLECTED FROM DEPUTY STEPHENS #2743

CODE	ITEM #	QTY	ITEM NAME	MAKE	MODEL / CALIBER	ID / SERIAL NUMBER
E K	11	2	MAGAZINE	SIG SAUER	9mm	15 ROUNDS EACH

PROF.AFFIL --- ADDITIONAL INFORMATION
COLLECTED FROM DEPUTY CERIO #3415

CODE	ITEM #	QTY	ITEM NAME	MAKE	MODEL / CALIBER	ID / SERIAL NUMBER
E K	12	1	MAGAZINE	SIG SAUER	9mm	12+1 ROUNDS

PROF.AFFIL --- ADDITIONAL INFORMATION
REMOVED FROM DEPUTY CERIO'S WEAPON

CODE	ITEM #	QTY	ITEM NAME	MAKE	MODEL / CALIBER	ID / SERIAL NUMBER
E K	13	2	MAGAZINE	SIG SAUER	9mm	15 ROUNDS EACH

PROF.AFFIL --- ADDITIONAL INFORMATION
COLLECTED FROM UNIT #3415

CODE	ITEM #	QTY	ITEM NAME	MAKE	MODEL / CALIBER	ID / SERIAL NUMBER
E K	14	1	MAGAZINE	SIG SAUER	9mm	10+1 ROUNDS

PROF.AFFIL --- ADDITIONAL INFORMATION
REMOVED FROM DEPUTY STEPHENS' WEAPON

Set 10 128

**PROPERTY / EVIDENCE
REPORT (Continuation)**

VENTURA COUNTY SHERIFF'S DEPARTMENT

AGENCY IDENTIFIER CA0560000

Page 3 of 8

41 RB NUMBER
03-08235

PROPERTY CLASSIFICATION CODE				PROPERTY CODES			
E - EVIDENCE SK - SAFEKEEPING		RC - RECOVERED PROPERTY FP - FOUND PROPERTY		A - CURRENCY/NOTES B - JEWELRY/PRECIOUS METALS C - CLOTHING/FURS	D - VEHICLE E - OFFICE EQUIPMENT F - ELECTRONIC EQUIPMENT	G - FIREARMS H - HOUSEHOLD GOODS I - CONSUMABLE GOODS	J - LIVESTOCK K - MISCELLANEOUS
CODE E K	ITEM # 15	QTY 2	ITEM NAME MAGAZINE	MAKE SIG SAUER	MODEL / CALIBER 9mm	ID / SERIAL NUMBER 15 ROUNDS EACH	
PROP.AFFIL ---	ADDITIONAL INFORMATION COLLECTED FROM DEPUTY STEPHENS #3338						
CODE E K	ITEM # 16	QTY 1	ITEM NAME BLINKER ASSEMBLY	MAKE ----	MODEL / CALIBER FRONT RIGHT	ID / SERIAL NUMBER ----	
PROP.AFFIL ---	ADDITIONAL INFORMATION COLLECTED FROM UNIT #3338						
CODE E K	ITEM # 17	QTY 1	ITEM NAME BUMPER	MAKE ----	MODEL / CALIBER FRONT	ID / SERIAL NUMBER ----	
PROP.AFFIL ---	ADDITIONAL INFORMATION COLLECTED FROM UNIT #3338						
CODE E K	ITEM # 18	QTY 1	ITEM NAME FENDER	MAKE ----	MODEL / CALIBER FRONT RIGHT	ID / SERIAL NUMBER ----	
PROP.AFFIL ---	ADDITIONAL INFORMATION COLLECTED FROM UNIT #3338						
CODE E K	ITEM # 19	QTY 1	ITEM NAME TIRE	MAKE GOODYEAR	MODEL / CALIBER WRANGLER	ID / SERIAL NUMBER REAR PASSENGER'S SIDE	
PROP.AFFIL ---	ADDITIONAL INFORMATION COLLECTED FROM [REDACTED] # [REDACTED]						
CODE E K	ITEM # 20	QTY 1	ITEM NAME TIRE	MAKE GOODYEAR	MODEL / CALIBER WRANGLER	ID / SERIAL NUMBER FRONT PASSENGER'S SIDE	
PROP.AFFIL ---	ADDITIONAL INFORMATION COLLECTED FROM [REDACTED] # [REDACTED]						
CODE E K	ITEM # 20	QTY 1	ITEM NAME WHEEL	MAKE ----	MODEL / CALIBER ----	ID / SERIAL NUMBER FRONT PASSENGER'S SIDE	
PROP.AFFIL ---	ADDITIONAL INFORMATION COLLECTED FROM [REDACTED] # [REDACTED]						
CODE E K	ITEM # 21	QTY 1	ITEM NAME TIRE	MAKE GOODYEAR	MODEL / CALIBER WRANGLER	ID / SERIAL NUMBER REAR DRIVER'S SIDE	
PROP.AFFIL ---	ADDITIONAL INFORMATION COLLECTED FROM [REDACTED] # [REDACTED]						
CODE E K	ITEM # 21	QTY 1	ITEM NAME WHEEL	MAKE ----	MODEL / CALIBER ----	ID / SERIAL NUMBER REAR DRIVER'S SIDE	
PROP.AFFIL ---	ADDITIONAL INFORMATION COLLECTED FROM [REDACTED] # [REDACTED]						
CODE E K	ITEM # 22	QTY 1	ITEM NAME PAINT	MAKE ----	MODEL / CALIBER ----	ID / SERIAL NUMBER ----	
PROP.AFFIL ---	ADDITIONAL INFORMATION COLLECTED FROM DRIVER'S DOOR ON UNIT #3415						
CODE K	ITEM # 23	QTY 1	ITEM NAME PAINT	MAKE ----	MODEL / CALIBER ----	ID / SERIAL NUMBER ----	
PROP.AFFIL ---	ADDITIONAL INFORMATION COLLECTED FROM FRONT PASSENGER'S SIDE FENDER ON UNIT #3338						

13 DATE / TIME OF REPORT
4-8-2003 / 1600

14 REPORTING OFFICER / ID NO./DIV./UNIT
E. [REDACTED] / 3832 / SPEC. SERV. / B.I.

15 APPROVED BY / ID NO.
[Signature] 1257

**PROPERTY / EVIDENCE
REPORT (Continuation)**

VENTURA COUNTY SHERIFF'S DEPARTMENT

AGENCY IDENTIFIER CA0560000

Page 4 of 8

41 RB NUMBER

03-08235

PROPERTY CLASSIFICATION CODE				PROPERTY CODES			
E - EVIDENCE SK - SAFEKEEPING		RC - RECOVERED PROPERTY FP - FOUND PROPERTY		A - CURRENCY/NOTES B - JEWELRY/PRECIOUS METALS C - CLOTHING/FURS	D - VEHICLE E - OFFICE EQUIPMENT F - ELECTRONIC EQUIPMENT	G - FIREARMS H - HOUSEHOLD GOODS I - CONSUMABLE GOODS	J - LIVESTOCK K - MISCELLANEOUS
CODE	ITEM #	QTY	ITEM NAME	MAKE	MODEL / CALIBER	ID / SERIAL NUMBER	
E K	24	1	HUBCAP	[REDACTED]	----	REAR DRIVER'S SIDE	
PROP.AFFIL	ADDITIONAL INFORMATION --- COLLECTED FROM CHEVROLET [REDACTED] # [REDACTED]						
E K	25	1	HUBCAP	[REDACTED]	----	FRONT PASSENGER'S SIDE	
PROP.AFFIL	ADDITIONAL INFORMATION --- COLLECTED FROM CHEVROLET [REDACTED] # [REDACTED]						
CODE	ITEM #	QTY	ITEM NAME	MAKE	MODEL / CALIBER	ID / SERIAL NUMBER	
PROP.AFFIL	ADDITIONAL INFORMATION						
CODE	ITEM #	QTY	ITEM NAME	MAKE	MODEL / CALIBER	ID / SERIAL NUMBER	
PROP.AFFIL	ADDITIONAL INFORMATION						
CODE	ITEM #	QTY	ITEM NAME	MAKE	MODEL / CALIBER	ID / SERIAL NUMBER	
PROP.AFFIL	ADDITIONAL INFORMATION						
CODE	ITEM #	QTY	ITEM NAME	MAKE	MODEL / CALIBER	ID / SERIAL NUMBER	
PROP.AFFIL	ADDITIONAL INFORMATION						
CODE	ITEM #	QTY	ITEM NAME	MAKE	MODEL / CALIBER	ID / SERIAL NUMBER	
PROP.AFFIL	ADDITIONAL INFORMATION						
CODE	ITEM #	QTY	ITEM NAME	MAKE	MODEL / CALIBER	ID / SERIAL NUMBER	
PROP.AFFIL	ADDITIONAL INFORMATION						
CODE	ITEM #	QTY	ITEM NAME	MAKE	MODEL / CALIBER	ID / SERIAL NUMBER	
PROP.AFFIL	ADDITIONAL INFORMATION						
CODE	ITEM #	QTY	ITEM NAME	MAKE	MODEL / CALIBER	ID / SERIAL NUMBER	
PROP.AFFIL	ADDITIONAL INFORMATION						
CODE	ITEM #	QTY	ITEM NAME	MAKE	MODEL / CALIBER	ID / SERIAL NUMBER	
PROP.AFFIL	ADDITIONAL INFORMATION						
CODE	ITEM #	QTY	ITEM NAME	MAKE	MODEL / CALIBER	ID / SERIAL NUMBER	
PROP.AFFIL	ADDITIONAL INFORMATION						

NARRATIVE REPORT VENTURA COUNTY SHERIFF'S DEPARTMENT

Page 5 of 8 - Continuation

AGENCY IDENTIFIER CA0560000

1 RD 3262	2 BEAT 3C2	3 RB NUMBER 03-08235
--------------	---------------	-------------------------

4 CODE	5 ITEM	6 QTY.	7 ITEM NAME	8 BRAND / MAKE MANUFACTURER	9 MODEL NAME OR NUMBER	10 MISC. DESCRIPTION	11 IDENTIFICATION / SERIAL NUMBER	12 VALUE
--------	--------	--------	-------------	-----------------------------	------------------------	----------------------	-----------------------------------	----------

Arrived at scene at approximately 2030 hours. Took overall and close-up photos of a [REDACTED] Photos show bullet strikes to front driver and passenger's side windows, bullet strikes to wheels, damage to driver's side front and rear fenders, exterior and interior of vehicle. Photos include keys in the vehicle's ignition in the "On" position and the dashboard showing that the vehicle was in "Drive". Photos also include suspect sitting in driver's seat and weapon on the suspect's left side on driver's seat. Photos were downloaded into the Ventura County Sheriff's Department digital archive.

Collected pieces of plastic from a turn signal, seven bullet casings and glass fragments.

Collected paint from the driver's door on patrol unit #3415 and paint from the front passenger's side fender on patrol unit #3338. Also collected suspect's weapon and magazine from weapon (12 rounds in the magazine and 1 in the chamber), a digital camera's memory card from Deputy Cerio's #3415 camera (images were downloaded into the Sheriff's digital archive), tape recorder from Deputy Cerio (Cassette tape was removed by Detective Montagna on 3-26-03), Deputy Cerio's duty weapon and magazine from weapon (12 rounds in the magazine and 1 in the chamber), two spare magazines from Deputy Cerio's duty belt and two magazines from Deputy Cerio's duty bag in patrol unit #3415. Collected Deputy Stephens' #2743 duty weapon and magazine from weapon (10 rounds in the magazine and 1 in the chamber) and two spare magazines from Deputy Stephens' duty belt.

On 4-2-03, I collected the front passenger's side blinker assembly, front passenger's side fender and front bumper on patrol unit #3338. Collected the rear passenger's tire on the suspect's vehicle [REDACTED], front passenger's side wheel, tire and hubcap from suspect's vehicle and rear driver's side tire, wheel and hubcap from the suspect's vehicle.

On 4-10-03, I opened items #4, #5, #9, #10, #11, #12, #13, #14 and #15 of evidence to photograph. The items consisted of all the weapons and ammunition that were collected at the scene.

13 DATE / TIME OF REPORT 4-08-03 / 1600	14 REPORTING OFFICER / ID NO / DIV / UNIT E. [REDACTED] / 3832 / SPEC. SERV. FBI.	15 APPROVED BY / ID NO [Signature] 12R
--------------------------------------------	--------------------------------------------------------------------------------------	-------------------------------------------

NARRATIVE REPORT VENTURA COUNTY SHERIFF'S DEPARTMENT

Page 6 of 8 Continuation

AGENCY IDENTIFIER CA0560000

1 RD 3262	2 BEAT 3C2	3 RB NUMBER 03-08235
--------------	---------------	-------------------------

4 CODE	5 ITEM	6 QTY.	7 ITEM NAME	8 BRAND / MAKE MANUFACTURER	9 MODEL NAME OR NUMBER	10 MISC. DESCRIPTION	11 IDENTIFICATION / SERIAL NUMBER	12 VALUE
--------	--------	--------	-------------	-----------------------------	------------------------	----------------------	-----------------------------------	----------

LEGEND

PHOTO MARKER

ITEM

#01	Broken turn signal cover
#04	Bullet casing
#05	Glass fragments
#06	Bullet casing
#07	Bullet casing
#08	Bullet casing
#09	Bullet casing
#10	Bullet casing
#11	Bullet casing
#2 & #3	Distance between tire mark
#12 & #13	Distance between tire mark

13 DATE / TIME OF REPORT

4-08-03 / 1600

14 REPORTING OFFICER / ID NO / DIV / UNIT

E. [REDACTED] / 3832 / SPEC. SERV. / B.I.

15 APPROVED BY / ID NO

[Signature] 1252
S/ST-ORR-ETC

NARRATIVE REPORT VENTURA COUNTY SHERIFF'S DEPARTMENT

Page 8 of 8 = Continuation

AGENCY IDENTIFIER CA0560000

1 RD 3262	2 BEAT 3C2	3 RB NUMBER 03-08235
--------------	---------------	-------------------------

4 CODE	5 ITEM	6 QTY.	7 ITEM NAME	8 BRAND / MAKE MANUFACTURER	9 MODEL NAME OR NUMBER	10 MISC. DESCRIPTION	11 IDENTIFICATION / SERIAL NUMBER	12 VALUE
--------	--------	--------	-------------	-----------------------------	------------------------	----------------------	-----------------------------------	----------

DRIVER'S DOOR

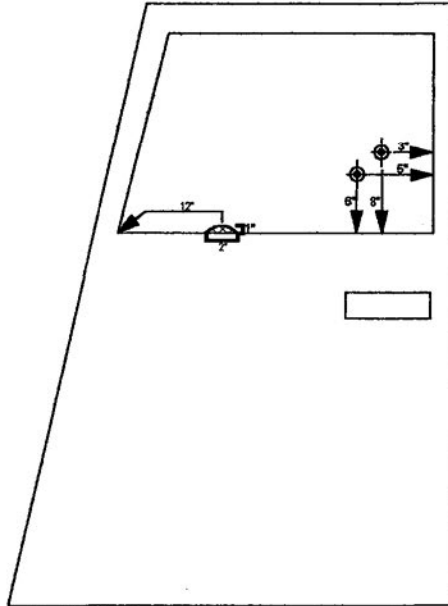

FRONT PASSENGER'S DOOR

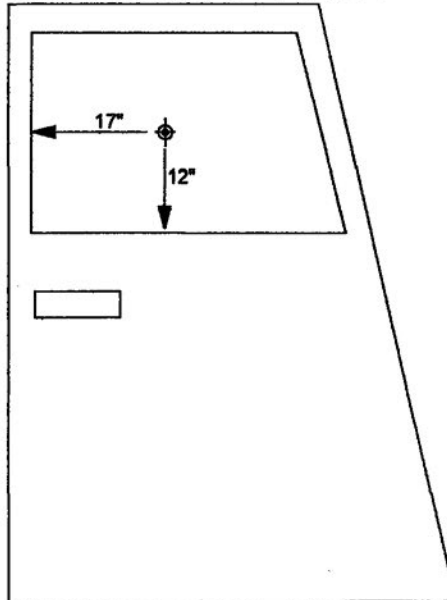

DIAGRAM NOT TO SCALE
MEASUREMENTS ARE APPROXIMATE

13 DATE / TIME OF REPORT 4-08-03 / 1600	14 REPORTING OFFICER / ID NO / DIV / UNIT E. [REDACTED] / 3832 / SPEC. SERV. / B.I.	15 APPROVED BY / ID NO SLT. OBRELO [Signature]
--------------------------------------------	----------------------------------------------------------------------------------------	---------------------------------------------------

PROPERTY / EVIDENCE REPORT

VENTURA COUNTY SHERIFF'S DEPARTMENT

AGENCY IDENTIFIER CA0560000

Page 1 of 3

CONNECTING REPORT NUMBERS MED. EXAMINER 601-03		2 R.D. 3262	3 BEAT 302	4 RB NUMBER 2003 - 08235
5 PROPERTY TYPE: <input checked="" type="checkbox"/> EVIDENCE <input type="checkbox"/> FOUND <input type="checkbox"/> SAFEKEEPING		6 <input type="checkbox"/> Misdemeanor <input type="checkbox"/> Felony		7 DATE OF INCIDENT 3-20-03
8 ORIGINAL INCIDENT / OFFENSE OFFICER INVOLVED SHOOTING		9 LOCATION OF INCIDENT (STREET ADDRESS AND CITY) MUGU BEACH MALIBU		
CODE: V - Victim S - Suspect A - Arrestee F - Finder O - Owner R - Reporting Party (Use Same Codes in Property Affiliation Box)				

CODE 10 S	11 NAME (Last, First, Middle, Gen.) / FIRM NAME PEARLMAN, NANCY	AKA / Moniker	RACE	SEX	14 DOB	15 BUSINESS PHONE ()
16 RESIDENCE ADDRESS / (<input type="checkbox"/> Same as Box# _____)						17 RESIDENCE PHONE ()
CODE 18	19 NAME (Last, First, Middle, Gen.) / FIRM NAME	AKA / Moniker	RACE 20	SEX 21	22 DOB	23 BUSINESS PHONE ()
24 RESIDENCE ADDRESS / (<input type="checkbox"/> Same as Box# _____)						25 RESIDENCE PHONE ()
CODE 26	27 NAME (Last, First, Middle, Gen.) / FIRM NAME	AKA / Moniker	RACE 28	SEX 29	30 DOB	31 BUSINESS PHONE ()
32 RESIDENCE ADDRESS / (<input type="checkbox"/> Same as Box# _____)						33 RESIDENCE PHONE ()

34 NARRATIVE

Narrative on P.3

Photos transferred to digital archive (scene-71, autopsy-39, aerials-23, evidence-10, patrol car-4)

35 PROPERTY / EVIDENCE INFORMATION

LOCATION BOOKED: Crime Lab E.C. _____ SEARCH WARRANT? Yes No FINDER WISHES TO CLAIM? Yes No

36 PROPERTY CLASSIFICATION CODE		PROPERTY CODES			
E - EVIDENCE	RC - RECOVERED PROPERTY	A - CURRENCY / NOTES	D - VEHICLE	G - FIREARMS	J - LIVESTOCK
SK-SAFEKEEPING	FP - FOUND PROPERTY	B - JEWELRY / PRECIOUS METALS	E - OFFICE EQUIPMENT	H - HOUSEHOLD GOODS	K - MISCELLANEOUS
		C - CLOTHING / FURS	F - ELECTRONIC EQUIPMENT	I - CONSUMABLE GOODS	

E/K	ITEM #	QTY	ITEM NAME	MAKE	MODEL / CALIBER	ID / SERIAL NUMBER
K	1	1	[REDACTED]			

PROP. AFFIL: **S** ADDITIONAL INFORMATION: **LICENSE [REDACTED]**

E/K	ITEM #	QTY	ITEM NAME	MAKE	MODEL / CALIBER	ID / SERIAL NUMBER
K	2	1	KEYS			

PROP. AFFIL: **S** ADDITIONAL INFORMATION: **VEH KEYS TO [REDACTED]**

E/K	ITEM #	QTY	ITEM NAME	MAKE	MODEL / CALIBER	ID / SERIAL NUMBER
K	3	1	8mm VIDEOTAPE			

PROP. AFFIL: **--** ADDITIONAL INFORMATION: **WALK-THRU WITH DEP. CERIO**

37 DATE AND TIME OF REPORT 3-22-03 1515	38 REPORTING OFFICER / ID NO. / DIV / UNIT I. [REDACTED] 3322 / Spec. Serv. / B.I.	39 APPROVED BY / ID NO. [Signature]
---------------------------------------------------	----------------------------------------------------------------------------------------------	-----------------------------------------------

40 COPIES TO DET / MC NARC GANG / SED STATS Press DOJ COURT OTHER

PROPEVD RPT
MAR 28 2003
WJ

**PROPERTY / EVIDENCE
REPORT**

VENTURA COUNTY SHERIFF'S DEPARTMENT

AGENCY IDENTIFIER CA0560000

Page 2 of 3

41 RB NUMBER
2003 - 08235

PROPERTY CLASSIFICATION CODE				PROPERTY CODES			
E - EVIDENCE		RC - RECOVERED PROPERTY		A - CURRENCY/NOTES	D - VEHICLE	G - FIREARMS	J - LIVESTOCK
SK - SAFEKEEPING		FP - FOUND PROPERTY		B - JEWELRY/PRECIOUS METALS	E - OFFICE EQUIPMENT	H - HOUSEHOLD GOODS	K - MISCELLANEOUS
				C - CLOTHING/FURS	F - ELECTRONIC EQUIPMENT	I - CONSUMABLE GOODS	
CODE E K	ITEM # 4	QTY 1	ITEM NAME BODY BAG	MAKE	MODEL / CALIBER	ID / SERIAL NUMBER	
PROP.AFFIL --	ADDITIONAL INFORMATION						
CODE E K	ITEM # 5	QTY 1	ITEM NAME BODY BAG SHEET	MAKE	MODEL / CALIBER	ID / SERIAL NUMBER	
PROP.AFFIL --	ADDITIONAL INFORMATION						
CODE E K	ITEM # 6	QTY 1	ITEM NAME GSR KIT	MAKE	MODEL / CALIBER	ID / SERIAL NUMBER	
PROP.AFFIL --	ADDITIONAL INFORMATION						
CODE E K	ITEM # 7	QTY 1	ITEM NAME FINGERPRINTS	MAKE	MODEL / CALIBER	ID / SERIAL NUMBER	
PROP.AFFIL --	ADDITIONAL INFORMATION						
CODE E K	ITEM # 8	QTY 1	ITEM NAME FTA BLOOD CARD	MAKE	MODEL / CALIBER	ID / SERIAL NUMBER	
PROP.AFFIL --	ADDITIONAL INFORMATION						
CODE E K	ITEM # 9	QTY 1	ITEM NAME BULLET	MAKE	MODEL / CALIBER	ID / SERIAL NUMBER	
PROP.AFFIL --	ADDITIONAL INFORMATION						
CODE E C	ITEM # 10	QTY 1	ITEM NAME BRA	MAKE	MODEL / CALIBER	ID / SERIAL NUMBER W/BLOOD	
PROP.AFFIL S	ADDITIONAL INFORMATION						
CODE E C	ITEM # 11	QTY 1	ITEM NAME PANTS	MAKE	MODEL / CALIBER WHITE	ID / SERIAL NUMBER W/BLOOD	
PROP.AFFIL S	ADDITIONAL INFORMATION						
CODE E C	ITEM # 12	QTY 1	ITEM NAME UNDERWEAR	MAKE	MODEL / CALIBER	ID / SERIAL NUMBER W/BLOOD	
PROP.AFFIL S	ADDITIONAL INFORMATION						
CODE E C	ITEM # 13	QTY 1	ITEM NAME SWEATER	MAKE	MODEL / CALIBER TURQUOISE	ID / SERIAL NUMBER W/BLOOD	
PROP.AFFIL S	ADDITIONAL INFORMATION						
CODE E C	ITEM # 14	QTY 2	ITEM NAME SHOES	MAKE	MODEL / CALIBER BLACK	ID / SERIAL NUMBER	
PROP.AFFIL S	ADDITIONAL INFORMATION						

MAR 28 2003 WND

NARRATIVE REPORT VENTURA COUNTY SHERIFF'S DEPARTMENT

1 R.D. 3262	2 BEAT 302	3 RB NUMBER 2003 - 08235
----------------	---------------	-----------------------------

Page 3 of 3

AGENCY IDENTIFIER CA0560000

4 CODE	5 ITEM	6 QTY.	7 ITEM NAME	8 BRAND / MAKE MANUFACTURER	9 MODEL / NAME OR NUMBER	10 MISC. DESCRIPTION	11 IDENTIFICATION / SERIAL NUMBER	12 VALUE
--------	--------	--------	-------------	-----------------------------	--------------------------	----------------------	-----------------------------------	----------

Scene 3-20-03

Arrived at the scene at 2045 hours.

Took overall photos of area by entrance to the parking lot showing three patrol cars and a [REDACTED]
Took overall photos of same area showing evidence photo markers 1-13.

Took overall exterior photos of [REDACTED] showing deceased suspect in front driver's seat. Took photos of two bullet holes in driver's door window and one bullet hole in the front passenger's door window. Took line of site and laser pointer photos to show bullet path through windows. Took photos of body bag seal.

Took photos of patrol unit 3415 showing damage to driver's door exterior. Took photos of patrol unit 3415 showing a micro cassette recorder on the front passenger's seat and extra loaded SIG-SAUER magazines in gear bag also on the front passenger's seat.

Taped video walk-thru of Dep. Cerio.

The Chevrolet [REDACTED] was transported to the Crime Lab garage and secured with sticker seals.

Autopsy 3-21-03

Arrived at the Medical Examiner's Office at 0830 hours. Took overall photos of suspect on gurney and on autopsy table. Took photos of bullet wound by left eye, and abrasions on neck, face, and right hand made by glass. Took photos showing damage to skull. Took photos of bullet recovered from brain. Took photos showing bullet trajectory into head.

Collected suspect's clothing, body bag, and body bag sheet. Received bullet and FTA blood card from M.E. staff. Completed GSR kit on suspect. Obtained suspect's fingerprints.

3-22-03

Arrived at the Heliport at 0930 hours. Took aerial photos of scene.

Crime Lab: Took photos of patrol unit 3338 showing damage to right front fender, right front light assembly, and front and rear bumper.

Took close-up photos of the following evidence collected from the scene:

<u>Photo Markers</u>	<u>Description</u>
1	Plastic Reflector Pieces
4, 6-11	9mm Casings
5	Glass Fragments

Note: Refer to FET [REDACTED]'s report for collection/booking of evidence from scene.

13 DATE / TIME OF REPORT 3-22-03 1515	14 REPORTING OFFICER / ID NO./DIV./UNIT I. [REDACTED] 3322 / Spec. Serv. / B.I. [Signature]	15 APPROVED BY / ID NO. [Signature]
------------------------------------------	------------------------------------------------------------------------------------------------	----------------------------------------

MAR 28 2003

PROPERTY / EVIDENCE REPORT

VENTURA COUNTY SHERIFF'S DEPARTMENT

AGENCY IDENTIFIER CA0560000

CONNECTING REPORT NUMBERS			2 R.D. 3262	3 BEAT 3C2	4 RB NUMBER 03-08235
---------------------------	--	--	----------------	---------------	-------------------------

5 PROPERTY TYPE: <input checked="" type="checkbox"/> EVIDENCE <input type="checkbox"/> FOUND <input type="checkbox"/> SAFEKEEPING	6 <input type="checkbox"/> Misdemeanor <input type="checkbox"/> Felony	7 DATE OF INCIDENT 3-20-03
--------------------------------------------------------------------------------------------------------------------------------------	---------------------------------------------------------------------------	-------------------------------

8 ORIGINAL INCIDENT / OFFENSE OFFICER INVOLVED SHOOTING	9 LOCATION OF INCIDENT (STREET ADDRESS AND CITY) MUGU BEACH
-------------------------------------------------------------------	-----------------------------------------------------------------------

CODE: V - Victim S - Suspect A - Arrestee F - Finder O - Owner R - Reporting Party (Use Same Codes in Property Affiliation Box)

CODE 10 S	11 NAME (Last, First, Middle, Gen.) / FIRM NAME PEARLMAN, NANCY	AKA / Moniker	RACE	SEX	DOB	15 BUSINESS PHONE ()
--------------	--------------------------------------------------------------------	---------------	------	-----	-----	--------------------------

16 RESIDENCE ADDRESS / (<input type="checkbox"/> Same as Box# _____)	CITY	STATE	ZIP	17 RESIDENCE PHONE ()
------------------------------------------------------------------------	------	-------	-----	---------------------------

CODE 18	19 NAME (Last, First, Middle, Gen.) / FIRM NAME	AKA / Moniker	RACE 20	SEX 21	22 DOB	23 BUSINESS PHONE ()
---------	-------------------------------------------------	---------------	---------	--------	--------	--------------------------

24 RESIDENCE ADDRESS / (<input type="checkbox"/> Same as Box# _____)	CITY	STATE	ZIP	25 RESIDENCE PHONE ()
------------------------------------------------------------------------	------	-------	-----	---------------------------

CODE 26	27 NAME (Last, First, Middle, Gen.) / FIRM NAME	AKA / Moniker	RACE 28	SEX 29	30 DOB	31 BUSINESS PHONE ()
---------	-------------------------------------------------	---------------	---------	--------	--------	--------------------------

32 RESIDENCE ADDRESS / (<input type="checkbox"/> Same as Box# _____)	CITY	STATE	ZIP	33 RESIDENCE PHONE ()
------------------------------------------------------------------------	------	-------	-----	---------------------------

34 NARRATIVE

SEE PAGE 2

35 PROPERTY / EVIDENCE INFORMATION

LOCATION BOOKED: <input checked="" type="checkbox"/> Crime Lab <input type="checkbox"/> E.C. <input type="checkbox"/>	SEARCH WARRANT? <input type="checkbox"/> Yes <input type="checkbox"/> No	FINDER WISHES TO CLAIM? <input type="checkbox"/> Yes <input type="checkbox"/> No
-----------------------------------------------------------------------------------------------------------------------	--------------------------------------------------------------------------	----------------------------------------------------------------------------------

36 PROPERTY CLASSIFICATION CODE	PROPERTY CODES
E - EVIDENCE SK-SAFEKEEPING RC - RECOVERED PROPERTY FP - FOUND PROPERTY	A - CURRENCY / NOTES D - VEHICLE B - JEWELRY / PRECIOUS METALS E - OFFICE EQUIPMENT G - FIREARMS J - LIVESTOCK C - CLOTHING / FURS F - ELECTRONIC EQUIPMENT H - HOUSEHOLD GOODS K - MISCELLANEOUS I - CONSUMABLE GOODS

E/K	ITEM #	QTY	ITEM NAME	MAKE	MODEL / CALIBER	ID / SERIAL NUMBER
	1	2	PAINT SCRAPINGS			

PROP.AFFIL	ADDITIONAL INFORMATION
	COLLECTED FROM THE REAR DRIVERS SIDE FENDER OF THE VEHICLE

E/K	ITEM #	QTY	ITEM NAME	MAKE	MODEL / CALIBER	ID / SERIAL NUMBER
	2	1	PAINT SCRAPINGS			

PROP.AFFIL	ADDITIONAL INFORMATION
	COLLECTED FROM THE FRONT DRIVERS SIDE FENDER OF THE VEHICLE

E/K	ITEM #	QTY	ITEM NAME	MAKE	MODEL / CALIBER	ID / SERIAL NUMBER
	3	1	MAGAZINE W/12 ROUNDS	GLOCK	.40 CAL	

PROP.AFFIL	ADDITIONAL INFORMATION
S	COLLECTED FROM THE CENTER CONSOLE OF THE VEHICLE

DATE AND TIME OF REPORT 3-25-03 2000 HOURS	38 REPORTING OFFICER / ID NO. / DIV / UNIT SPEC SERV/BI 028A3381	39 APPROVED BY / ID NO. Sgt. O'Brien 128
-----------------------------------------------	---------------------------------------------------------------------	---------------------------------------------

40 COPIES TO DET / MC NARC GANG / SED STATS Press DOJ COURT OTHER

MAR 28 2003

NARRATIVE REPORT VENTURA COUNTY SHERIFF'S DEPARTMENT

Page 2 of 2

AGENCY IDENTIFIER CA0560000

1 R.D. 3262	2 BEAT 3C2	3 RB NUMBER 03-08235
----------------	---------------	-------------------------

4 CODE	5 ITEM	6 QTY.	7 ITEM NAME	8 BRAND / MAKE MANUFACTURER	9 MODEL / NAME OR NUMBER	10 MISC. DESCRIPTION	11 IDENTIFICATION / SERIAL NUMBER	12 VALUE
--------	--------	--------	-------------	-----------------------------	--------------------------	----------------------	-----------------------------------	----------

Crime Lab: I took overall exterior and interior photos of a [REDACTED] The VIN is [REDACTED] I took close up photos of damage to the front and rear driver's side fenders. I also took close up photos of each rim and tire. The photos show a bullet hole in the front and rear passenger's side tires. I photographed a possible bullet strike on the front passenger's side rim and two possible bullet strikes on the rear driver's side rim. Photos of bullet holes in the windows were also taken. I collected a loaded magazine from the center console of the vehicle and paint samples from the damaged front and rear driver's side fenders.

13 DATE / TIME OF REPORT 3-25-03 2000 HOURS	14 REPORTING OFFICER ID NO./DIV./UNIT [REDACTED] /SPEC SERV/BI [Signature]	15 APPROVED BY / ID NO. Sgt. OBRELO [Signature]
------------------------------------------------	-------------------------------------------------------------------------------	----------------------------------------------------

MAR 28 2003

PROPERTY / EVIDENCE REPORT

VENTURA COUNTY SHERIFF'S DEPARTMENT

AGENCY IDENTIFIER CA0560000

Page 1 of 1

CONNECTING REPORT NUMBERS		2 R.D. 3262	3 BEAT 302	4 RB NUMBER 2003 - 08235
---------------------------	--	----------------	---------------	-----------------------------

5 PROPERTY TYPE: <input checked="" type="checkbox"/> EVIDENCE <input type="checkbox"/> FOUND <input type="checkbox"/> SAFEKEEPING	6 <input type="checkbox"/> Misdemeanor <input type="checkbox"/> Felony	7 DATE OF INCIDENT 3-20-03
--------------------------------------------------------------------------------------------------------------------------------------	---------------------------------------------------------------------------	-------------------------------

8 ORIGINAL INCIDENT / OFFENSE OFFICER INVOLVED SHOOTING	9 LOCATION OF INCIDENT (STREET ADDRESS AND CITY) MUGU BEACH MALIBU
-------------------------------------------------------------------	------------------------------------------------------------------------------

CODE: V - Victim S - Suspect A - Arrestee F - Finder O - Owner R - Reporting Party (Use Same Codes in Property Affiliation Box)

CODE 10 S	11 NAME (Last, First, Middle, Gen.) / FIRM NAME PEARLMAN, NANCY	AKA / Moniker	RACE	SEX	14 DOB	15 BUSINESS PHONE ()
--------------	---------------------------------------------------------------------------	---------------	------	-----	--------	--------------------------

16 RESIDENCE ADDRESS / (<input type="checkbox"/> Same as Box# _____)	CITY	STATE	ZIP	17 RESIDENCE PHONE ()
------------------------------------------------------------------------	------	-------	-----	---------------------------

CODE 18	19 NAME (Last, First, Middle, Gen.) / FIRM NAME	AKA / Moniker	RACE 20	SEX 21	22 DOB	23 BUSINESS PHONE ()
---------	-------------------------------------------------	---------------	---------	--------	--------	--------------------------

24 RESIDENCE ADDRESS / (<input type="checkbox"/> Same as Box# _____)	CITY	STATE	ZIP	25 RESIDENCE PHONE ()
------------------------------------------------------------------------	------	-------	-----	---------------------------

CODE 26	27 NAME (Last, First, Middle, Gen.) / FIRM NAME	AKA / Moniker	RACE 28	SEX 29	30 DOB	31 BUSINESS PHONE ()
---------	-------------------------------------------------	---------------	---------	--------	--------	--------------------------

32 RESIDENCE ADDRESS / (<input type="checkbox"/> Same as Box# _____)	CITY	STATE	ZIP	33 RESIDENCE PHONE ()
------------------------------------------------------------------------	------	-------	-----	---------------------------

34 NARRATIVE

Crime Lab Garage: Processing of [REDACTED]

3-25-03 | Took photos of passenger's side tires removed from wheel showing bullet holes in tires.

3-26-03 | Took photos of lead test swabs on rear driver's side wheel.

Photos transferred to digital archive (14-tires, 8-wheel).

Copied images from compact flash card (Dep. Cerio's camera) to CD; both CD and CFC returned to FET [REDACTED].

35 PROPERTY / EVIDENCE INFORMATION

LOCATION BOOKED: <input type="checkbox"/> Crime Lab <input type="checkbox"/> E.C. <input type="checkbox"/> _____	SEARCH WARRANT? <input type="checkbox"/> Yes <input type="checkbox"/> No	FINDER WISHES TO CLAIM? <input type="checkbox"/> Yes <input type="checkbox"/> No
------------------------------------------------------------------------------------------------------------------	--------------------------------------------------------------------------	----------------------------------------------------------------------------------

36 PROPERTY CLASSIFICATION CODE	PROPERTY CODES
E - EVIDENCE SK-SAFEKEEPING	A - CURRENCY / NOTES B - JEWELRY / PRECIOUS METALS C - CLOTHING / FURS
RC - RECOVERED PROPERTY FP - FOUND PROPERTY	D - VEHICLE E - OFFICE EQUIPMENT F - ELECTRONIC EQUIPMENT
	G - FIREARMS H - HOUSEHOLD GOODS I - CONSUMABLE GOODS
	J - LIVESTOCK K - MISCELLANEOUS

ITEM #	QTY	ITEM NAME	MAKE	MODEL / CALIBER	ID / SERIAL NUMBER
--------	-----	-----------	------	-----------------	--------------------

PROP.AFFIL	ADDITIONAL INFORMATION				
------------	------------------------	--	--	--	--

ITEM #	QTY	ITEM NAME	MAKE	MODEL / CALIBER	ID / SERIAL NUMBER
--------	-----	-----------	------	-----------------	--------------------

PROP.AFFIL	ADDITIONAL INFORMATION				
------------	------------------------	--	--	--	--

ITEM #	QTY	ITEM NAME	MAKE	MODEL / CALIBER	ID / SERIAL NUMBER
--------	-----	-----------	------	-----------------	--------------------

PROP.AFFIL	ADDITIONAL INFORMATION				
------------	------------------------	--	--	--	--

37 DATE AND TIME OF REPORT 4-2-03 2230	38 REPORTING OFFICER / ID NO. / DIV / UNIT I. [REDACTED] 3322 / Spec. Serv. / B.I.	39 APPROVED BY / ID NO. [Signature]
-------------------------------------------	---------------------------------------------------------------------------------------	----------------------------------------

40 COPIES TO <input type="checkbox"/> DET / MC <input type="checkbox"/> NARC <input type="checkbox"/> GANG / SED <input type="checkbox"/> STATS <input type="checkbox"/> Press <input type="checkbox"/> DOJ <input type="checkbox"/> COURT <input type="checkbox"/> OTHER

PROPERTY / EVIDENCE REPORT

VENTURA COUNTY SHERIFF'S DEPARTMENT

AGENCY IDENTIFIER CA0560000

CONNECTING REPORT NUMBERS		2 R.D. 3262	3 BEAT 302	4 RB NUMBER 03-08235
---------------------------	--	----------------	---------------	-------------------------

5 PROPERTY TYPE: <input checked="" type="checkbox"/> EVIDENCE <input type="checkbox"/> FOUND <input type="checkbox"/> SAFEKEEPING	6 <input type="checkbox"/> Misdemeanor <input type="checkbox"/> Felony	7 DATE OF INCIDENT 3-20-03
8 ORIGINAL INCIDENT / OFFENSE OFFICER INVOLVED SHOOTING	9 LOCATION OF INCIDENT (STREET ADDRESS AND CITY) MUGU BEACH	

CODE: V - Victim S - Suspect A - Arrestee F - Finder O - Owner R - Reporting Party (Use Same Codes in Property Affiliation Box)

10 CODE S	11 NAME (Last, First, Middle, Gen.) / FIRM NAME PEARLMAN, NANCY	AKA / Moniker	RACE	SEX	14 DOB	15 BUSINESS PHONE ()
16 RESIDENCE ADDRESS / (<input type="checkbox"/> Same as Box# _____)						17 RESIDENCE PHONE ()
18 CODE	19 NAME (Last, First, Middle, Gen.) / FIRM NAME	AKA / Moniker	20 RACE	21 SEX	22 DOB	23 BUSINESS PHONE ()
24 RESIDENCE ADDRESS / (<input type="checkbox"/> Same as Box# _____)						25 RESIDENCE PHONE ()
26 CODE	27 NAME (Last, First, Middle, Gen.) / FIRM NAME	AKA / Moniker	28 RACE	29 SEX	30 DOB	31 BUSINESS PHONE ()
32 RESIDENCE ADDRESS / (<input type="checkbox"/> Same as Box# _____)						33 RESIDENCE PHONE ()

34 **NARRATIVE**

35 **PROPERTY / EVIDENCE INFORMATION**

LOCATION BOOKED: Crime Lab E.C. _____ SEARCH WARRANT? Yes No FINDER WISHES TO CLAIM? Yes No

36 **PROPERTY CLASSIFICATION CODE**

E - EVIDENCE	RC - RECOVERED PROPERTY	A - CURRENCY / NOTES	D - VEHICLE	G - FIREARMS	J - LIVESTOCK
SK-SAFEKEEPING	FP - FOUND PROPERTY	B - JEWELRY / PRECIOUS METALS	E - OFFICE EQUIPMENT	H - HOUSEHOLD GOODS	K - MISCELLANEOUS
		C - CLOTHING / FURS	F - ELECTRONIC EQUIPMENT	I - CONSUMABLE GOODS	

E K	ITEM # 50	QTY 2	ITEM NAME GLASS STANDARDS	MAKE _____	MODEL / CALIBER _____	ID / SERIAL NUMBER _____
--------	--------------	----------	------------------------------	---------------	--------------------------	-----------------------------

PROP.AFFIL: _____ ADDITIONAL INFORMATION: COLLECTED FROM THE FRONT DRIVERS SIDE WINDOW AND THE FRONT PASSENGERS SIDE WINDOW OF VEHICLE LIC# 41-XXXXXX

ITEM #	QTY	ITEM NAME	MAKE	MODEL / CALIBER	ID / SERIAL NUMBER
--------	-----	-----------	------	-----------------	--------------------

PROP.AFFIL: _____ ADDITIONAL INFORMATION: _____

ITEM #	QTY	ITEM NAME	MAKE	MODEL / CALIBER	ID / SERIAL NUMBER
--------	-----	-----------	------	-----------------	--------------------

PROP.AFFIL: _____ ADDITIONAL INFORMATION: _____

37 DATE AND TIME OF REPORT 4-01-03 1545 HOURS	38 REPORTING OFFICER / ID NO. / DIV / UNIT [REDACTED] / SPECSERV/BI 0243381	39 APPROVED BY / ID NO. [SIGNATURE] 1252
--------------------------------------------------	--------------------------------------------------------------------------------	---------------------------------------------

40 COPIES TO DET / MC NARC GANG / SED STATS Press DOJ COURT OTHER _____

PROPERTY / EVIDENCE REPORT

VENTURA COUNTY SHERIFF'S DEPARTMENT

AGENCY IDENTIFIER CA0560000

CONNECTING REPORT NUMBERS			2 R.D. 3261	3 BEAT 3C	4 RB NUMBER 03-8235
---------------------------	--	--	----------------	--------------	------------------------

5 PROPERTY TYPE: <input checked="" type="checkbox"/> EVIDENCE <input type="checkbox"/> FOUND <input type="checkbox"/> SAFEKEEPING	6 <input type="checkbox"/> Misdemeanor <input type="checkbox"/> Felony	7 DATE OF INCIDENT 3-20-03
8 ORIGINAL INCIDENT/OFFENSE OFFICER INVOLVED SHOOTING	9 LOCATION OF INCIDENT (STREET ADDRESS AND CITY) Pt. Mugu State Beach	

CODE: V - Victim S - Suspect A - Arrestee F - Finder O - Owner R - Reporting Party (Use Same Codes in Property Affiliation Box)							
10 CODE V	11 NAME (Last, First, Middle, Gen.) / FIRM NAME STEPHENS, JASON, SR. DEPUTY	AKA / Moniker	RACE W	SEX M	14 DOB	15 BUSINESS PHONE ()	
16 RESIDENCE ADDRESS / (<input type="checkbox"/> Same as Box #) V.C.S.O.			CITY	STATE	ZIP	17 RESIDENCE PHONE ()	
18 CODE	19 NAME (Last, First, Middle, Gen.) / FIRM NAME	AKA / Moniker	RACE 20	SEX 21	22 DOB	23 BUSINESS PHONE ()	
24 RESIDENCE ADDRESS / (<input type="checkbox"/> Same as Box #)			CITY	STATE	ZIP	25 RESIDENCE PHONE ()	
26 CODE	27 NAME (Last, First, Middle, Gen.) / FIRM NAME	AKA / Moniker	RACE 28	SEX 29	30 DOB	31 BUSINESS PHONE ()	
32 RESIDENCE ADDRESS / (<input type="checkbox"/> Same as Box #)			CITY	STATE	ZIP	33 RESIDENCE PHONE ()	

34 NARRATIVE
OFFICER INVOLVED SHOOTING

35 PROPERTY / EVIDENCE INFORMATION

LOCATION BOOKED: Crime Lab E.C. _____ SEARCH WARRANT? Yes No FINDER WISHES TO CLAIM? Yes No

36 PROPERTY CLASSIFICATION CODES

E - EVIDENCE	RC - RECOVERED PROPERTY	A - CURRENCY/NOTES	D - VEHICLE	G - FIREARMS	J - LIVESTOCK
SK - SAFEKEEPING	FP - FOUND PROPERTY	B - JEWELRY/PRECIOUS METALS	E - OFFICE EQUIPMENT	H - HOUSEHOLD GOODS	K - MISCELLANEOUS
		C - CLOTHING/FURS	F - ELECTRONIC EQUIPMENT	I - CONSUMABLE GOODS	

CODE	ITEM #	QTY	ITEM NAME	MAKE	MODEL / CALIBER	ID / SERIAL NUMBER
EK	1	1	AUDIO TAPE			

PROP AFFIL: ADDITIONAL INFORMATION
INTERVIEWS W/ FIREMEN.

CODE	ITEM #	QTY	ITEM NAME	MAKE	MODEL / CALIBER	ID / SERIAL NUMBER
EK	2	2	Video tapes			

PROP AFFIL: ADDITIONAL INFORMATION
1 - SCENE 2 - CERIO WALK-THRU

CODE	ITEM #	QTY	ITEM NAME	MAKE	MODEL / CALIBER	ID / SERIAL NUMBER

PROP AFFIL: ADDITIONAL INFORMATION

37 DATE AND TIME OF REPORT 4-17-03 / 1600	38 REPORTING OFFICER / ID NO. / DIV / UNIT E. Montefino 1047 / Sgt.	39 APPROVED BY / ID NO. D. AGUILAR #2234
----------------------------------------------	------------------------------------------------------------------------	---------------------------------------------

40 COPIES TO DET/MC NARC GANG/SED STATS PRESS DOJ COURT OTHER

PROPERTY / EVIDENCE REPORT

VENTURA COUNTY SHERIFF'S DEPARTMENT

AGENCY IDENTIFIER CA0560000

CONNECTING REPORT NUMBERS	2 R.D. 8262	3 BEAT 3C	4 RB NUMBER 03-8535
---------------------------	-----------------------	---------------------	-------------------------------

5 PROPERTY TYPE: <input checked="" type="checkbox"/> EVIDENCE <input type="checkbox"/> FOUND <input type="checkbox"/> SAFEKEEPING	6 <input type="checkbox"/> Misdemeanor <input type="checkbox"/> Felony	7 DATE OF INCIDENT
--------------------------------------------------------------------------------------------------------------------------------------	---------------------------------------------------------------------------	--------------------

8 ORIGINAL INCIDENT / OFFENSE OFFICER INVOLVED SHOOTING	9 LOCATION OF INCIDENT (STREET ADDRESS AND CITY) MILLER BEACH
-------------------------------------------------------------------	-------------------------------------------------------------------------

CODE: V - Victim S - Suspect A - Arrestee F - Finder O - Owner R - Reporting Party (Use Same Codes in Property Affiliation Box)

CODE	11	NAME (Last, First, Middle, Gen.) / FIRM NAME PEARLMAN, NANCY	AKA / Moniker	RACE	SEX	14 DOB	15 BUSINESS PHONE
------	----	------------------------------------------------------------------------	---------------	------	-----	--------	-------------------

16	RESIDENCE ADDRESS / (<input type="checkbox"/> Same as Box #)	CITY	STATE	ZIP	17 RESIDENCE PHONE
----	----------------------------------------------------------------	------	-------	-----	--------------------

CODE	19	NAME (Last, First, Middle, Gen.) / FIRM NAME	AKA / Moniker	RACE	SEX	22 DOB	23 BUSINESS PHONE
------	----	----------------------------------------------	---------------	------	-----	--------	-------------------

24	RESIDENCE ADDRESS / (<input type="checkbox"/> Same as Box #)	CITY	STATE	ZIP	25 RESIDENCE PHONE
----	----------------------------------------------------------------	------	-------	-----	--------------------

CODE	27	NAME (Last, First, Middle, Gen.) / FIRM NAME	AKA / Moniker	RACE	SEX	30 DOB	31 BUSINESS PHONE
------	----	----------------------------------------------	---------------	------	-----	--------	-------------------

32	RESIDENCE ADDRESS / (<input type="checkbox"/> Same as Box #)	CITY	STATE	ZIP	33 RESIDENCE PHONE
----	----------------------------------------------------------------	------	-------	-----	--------------------

34 NARRATIVE

AUDIO TAPE-RECORDED INTERVIEWS W/ WITNESSES

35 PROPERTY / EVIDENCE INFORMATION

LOCATION BOOKED: <input checked="" type="checkbox"/> Crime Lab <input type="checkbox"/> E.C. <input type="checkbox"/> _____	SEARCH WARRANT ? <input type="checkbox"/> Yes <input checked="" type="checkbox"/> No	FINDER WISHES TO CLAIM? <input type="checkbox"/> Yes <input checked="" type="checkbox"/> No
-----------------------------------------------------------------------------------------------------------------------------	--------------------------------------------------------------------------------------	---------------------------------------------------------------------------------------------

36 PROPERTY CLASSIFICATION CODES

E - EVIDENCE	RC - RECOVERED PROPERTY	A - CURRENCY/NOTES	D - VEHICLE	G - FIREARMS	J - LIVESTOCK
SK - SAFEKEEPING	FP - FOUND PROPERTY	B - JEWELRY/PRECIOUS METALS	E - OFFICE EQUIPMENT	H - HOUSEHOLD GOODS	K - MISCELLANEOUS
		C - CLOTHING/FURS	F - ELECTRONIC EQUIPMENT	I - CONSUMABLE GOODS	

CODE	FK	ITEM #	1	QTY	15	ITEM NAME	MAKE	MODEL / CALIBER	ID / SERIAL NUMBER
------	----	--------	---	-----	----	-----------	------	-----------------	--------------------

PROP AFFIL: **ADDITIONAL INFORMATION**
WITNESSES

CODE	FK	ITEM #	2	QTY	1	ITEM NAME	MAKE	MODEL / CALIBER	ID / SERIAL NUMBER
------	----	--------	---	-----	---	-----------	------	-----------------	--------------------

PROP AFFIL: **ADDITIONAL INFORMATION**
CERIO'S RECORDING OF SHOOTING INCIDENT.

CODE		ITEM #		QTY		ITEM NAME	MAKE	MODEL / CALIBER	ID / SERIAL NUMBER
------	--	--------	--	-----	--	-----------	------	-----------------	--------------------

PROP AFFIL: **ADDITIONAL INFORMATION**

37 DATE AND TIME OF REPORT	38 REPORTING OFFICER / ID NO. / DIV / UNIT S. Montoya 1047	39 APPROVED BY / ID NO. D. AGUILAR #22
----------------------------	----------------------------------------------------------------------	--------------------------------------------------

40 COPIES TO DET / MC NARC GANG / SED STATS PRESS DOJ COURT OTHER

NARRATIVE REPORT VENTURA COUNTY SHERIFF'S DEPARTMENT

Page 1 of 1 Continuation

AGENCY IDENTIFIER CA0560000

1 R.D. 3261	2 BEAT 3C	3 RB NUMBER 03-8235
----------------	--------------	------------------------

4 CODE	5 ITEM	6 QTY.	7 ITEM NAME	8 BRAND / MAKE MANUFACTURER	9 MODEL NAME OR NUMBER	10 MISC. DESCRIPTION	11 IDENTIFICATION / SERIAL NUMBER	12 VALUE
--------	--------	--------	-------------	-----------------------------	------------------------	----------------------	-----------------------------------	----------

Supplemental Case Cleared

Gang Domestic Hate Child Abuse Elderly Abuse

Connecting Report Numbers:

Code Section / Description: **OFFICER INVOLVED SHOOTING**

Code: **SUSPECT** Name: **PEARLMAN, NANCY**

On 4-3-03, with the assistance of FET [REDACTED] and Fleet Services Tire Specialist, Alfredo [REDACTED], we removed the following tires and rims from the suspect's vehicle. The suspect's vehicle has been stored in the Crime Lab locked garage. The below tires and rims were booked into property:

- L/R tire and rim
- R/F tire and rim
- R/R tire

On 4-3-03, I drove Stephens' patrol unit to Fleet Services Body Shop, located at 664 El Rio Drive, Oxnard. The patrol unit had been parked in the parking area outside the Crime Lab garage located adjacent to the Main Jail. While in the present of FET [REDACTED] and myself, technicians removed the fender, bumper, and turn signal panel. Upon removal of the items from the patrol unit, FET [REDACTED] seized the parts and booked them into property. FET [REDACTED] also took photographs of the patrol car with the parts removed. There was no other damage to the car related to the accident. The patrol car was released to the body shop for repairs.

13 DATE / TIME OF REPORT
04/03/03 / 15:55

14 REPORTING OFFICER / ID NO / DIV / UNIT
E. Montagna #1047 / Sgt.

15 APPROVED BY / ID NO
D. AGUILAR #2234



COUNTY OF VENTURA SHERIFF'S DEPARTMENT

800 S. VICTORIA AVENUE VENTURA, CA 93009 (805) 654-2370
FORENSIC SCIENCES LABORATORY REPORT

LAB CASE NUMBER
L03-1763

SUBJECT(S):	
SUSPECT:	PEARLMAN, NANCY
VICTIM:	STEPHENS
VICTIM:	CERIO
AGENCY:	
VENTURA COUNTY SHERIFF'S DEPARTMENT	
Attn: Sgt. Ernie Montagna Major Crimes	
AGENCY CASE NUMBER:	OFFENSE(S)
03-08235	INCIDENT, OFFICER INVOLVED

TRACE SECTION

EVIDENCE: On July 29, 2003 the following items were received from property:

Item 023 – (agency item 1) pieces of colorless and amber lens reportedly from near photo marker 1.

Item 038 – (agency item 16) the front passenger side signal assembly reportedly from unit 3338.

Item 040 – (agency item 18) the front passenger side fender reportedly from unit 3338. This item was briefly examined, but not used for purposes of this report.

OBJECTIVE: Determine if the pieces of lens in item 023 were originally part of the signal assembly in item 038.

RESULTS: The following is a summary of the analytic findings:

The pieces of lens in item 023 physically fit together to form most of a turn signal lens. The largest piece of lens in item 023 physically fits with a portion of plastic lens remaining on the signal assembly, item 038, to form one unit.

CONCLUSION:

Item 023 and item 038 were once connected to form a single passenger side signal assembly.

DISPOSITION OF EVIDENCE:

Evidence was returned to the original packaging.

Helen [redacted]
FORENSIC SCIENTIST
08/07/2003



COUNTY OF VENTURA SHERIFF'S DEPARTMENT

800 S. VICTORIA AVENUE VENTURA, CA 93009 (805) 654-2370
FORENSIC SCIENCES LABORATORY REPORT

**LAB CASE
NUMBER
L03-1763**

SUBJECT(S): SUSPECT: PEARLMAN, NANCY VICTIM: STEPHENS VICTIM: CERIO	
AGENCY: VENTURA COUNTY SHERIFF'S DEPARTMENT	
Attn: Sgt. Ernie Montagna Major Crimes	
AGENCY CASE NUMBER: 03-08235	OFFENSE(S) INCIDENT, OFFICER INVOLVED

TRACE SECTION

EVIDENCE: On June 11, 2003 the following item was received from property:

026 - (agency item 4) a 9mm Smith & Wesson Model 59 gun.

OBJECTIVE: Collect glass from the gun, item 026.

RESULTS: The following is a summary of the analytic findings:

The gun was examined for fragments with a stereomicroscopic (approximately 7.5 times magnification) appearance of glass. Colorless fragments were collected from fifteen different areas on the gun. These fragments were collected from most of the exposed surfaces of the gun. No fragments were recovered from inside of the barrel.

Fragments were also collected from the magazine, item 027, while in the custody of Jim [REDACTED]

While examining the gun for glass fragments, fine red-brown spatter was noted in the area of the "SMITH & WESSON" on the slide. The gun was turned over to forensic scientist Ed [REDACTED] for possible blood spatter interpretation.

COMMENTS:

During examination of the gun, item 026, it was not determined which of the collected fragments were deposited directly onto the gun from the window and which fragments became associated with the gun from contact with glass on the driver's seat and/or from handling.

DISPOSITION OF EVIDENCE:

The colorless fragments collected from the gun, item 026, and magazine, item 027, were placed onto post-it notes in plastic bags and returned to the original items.

Helen [REDACTED]
FORENSIC SCIENTIST
06/27/2003



COUNTY OF VENTURA SHERIFF'S DEPARTMENT

800 S. VICTORIA AVENUE VENTURA, CA 93009 (805) 654-2370
FORENSIC SCIENCES LABORATORY REPORT

LAB CASE NUMBER
L03-1763

SUBJECT(S): SUSPECT: PEARLMAN, NANCY VICTIM: STEPHENS VICTIM: CERIO	
AGENCY: VENTURA COUNTY SHERIFF DEPARTMENT Attn: DET. MONTAGNA	
AGENCY CASE NUMBER: 03-08235	OFFENSE (S) INCIDENT, OFFICER INVOLVED

TRACE SECTION

EVIDENCE: On 6/27/2003 the following item was received from Forensic Scientist Helen [REDACTED]

[REDACTED]
Photographs of crime scene and autopsy.

OBJECTIVE: Blood stain pattern analysis.

RESULTS:

1. A stain pattern consisting of 18 reddish [REDACTED] spatters (each smaller than 1 mm) was observed on the left side of the pistol item 26. See Photo 1. Six of these reddish [REDACTED] spatters gave a positive presumptive test for blood. The other 12 spatters were not tested. This pattern extends approximately 3" from above the leading edge of the trigger guard "B" in Photo 1 to under the safety "G" and down to the top of the top of the trigger guard area on the grip "F". This bloodstain pattern is consistent with a blowback from a bullet entering a part of the head not covered with hair.
2. When the pistol item 26 is held with the grip in the right hand, the bloodstain pattern is not obscured. When the pistol is held with the grip in the left hand, blood spatter "F" (see Photo 1) and possibly blood spatter "E" from the pistol grip are obscured by the left hand. In other words when the pistol is held in a normal manner (hand around grip and forefinger on trigger) it could have been held in the right hand and could not be held in the left hand when the blood pattern was deposited.
3. Examination of crime scene photograph 33N05931 shows the deceased subject strapped into the drivers seat and the 9mm Model 59 (item 26) on the seat beside her with the barrel on the seat and the bottom of the grip (butt end) leaning against her left forearm near the elbow. A red (obvious blood impression) straight-line mark is present on her forearm just in front of the area where the pistol butt is touching her left forearm. The bottom of the grip that was then repositioned into its current position probably caused this straight-line bloody imprint. In other words the pistol was in a position approximately 1 inch forward (closer to the wrist) before it was moved. Blood began to flow down the left side of the subject almost immediately after the bullet wound to the eye. The pistol had to be in a position to be touched by that blood flow (there was a blood flow present on the outside of the left grip as well as inside the grip where the magazine would normally reside). The straight-line mark on the forearm would mark this original location. The pistol had to get in this position quickly to have blood flow down the grip. In other words it could not have been on the subject's lap when the bullet entered the subject's eye.

4. Examination of autopsy photograph 33L05795 shows numerous injuries from secondary projectiles (flying glass from gun shots through driver's side window) on the left side of the subject's face and neck, left shoulder, web of right hand, right forearm (just above wrist) and on the front surface of the middle finger of the right hand above the finger-hand joint and below the first finger joint. The injury to the middle finger is also visible on autopsy photograph 33L05786. By shifting the grip on the pistol, the flying glass injuries to the web of the right hand can be shielded by the pistol or not shielded by the pistol. By changing the angle of the wrist, the direction that the pistol is pointed will change. These injuries are consistent with the subject pointing the pistol with her right hand at the inside of the driver's window when one or both bullets penetrated the driver's window creating a spray of secondary glass projectiles.

CONCLUSION:

Examination and analysis of the blood spatter pattern on the pistol item 26, the crime scene photographs and the autopsy photographs shows that the evidence is consistent with the subject pointing the pistol at the inside of the driver's door window when she was shot in the left eye.

REMARK:

Examination of photograph 33N05932 shows evidence that the pistol item 26 was most likely moved before this photograph was taken.

Edwin L. Jones Jr

Edwin [REDACTED]
Forensic Scientist
8/13/2003

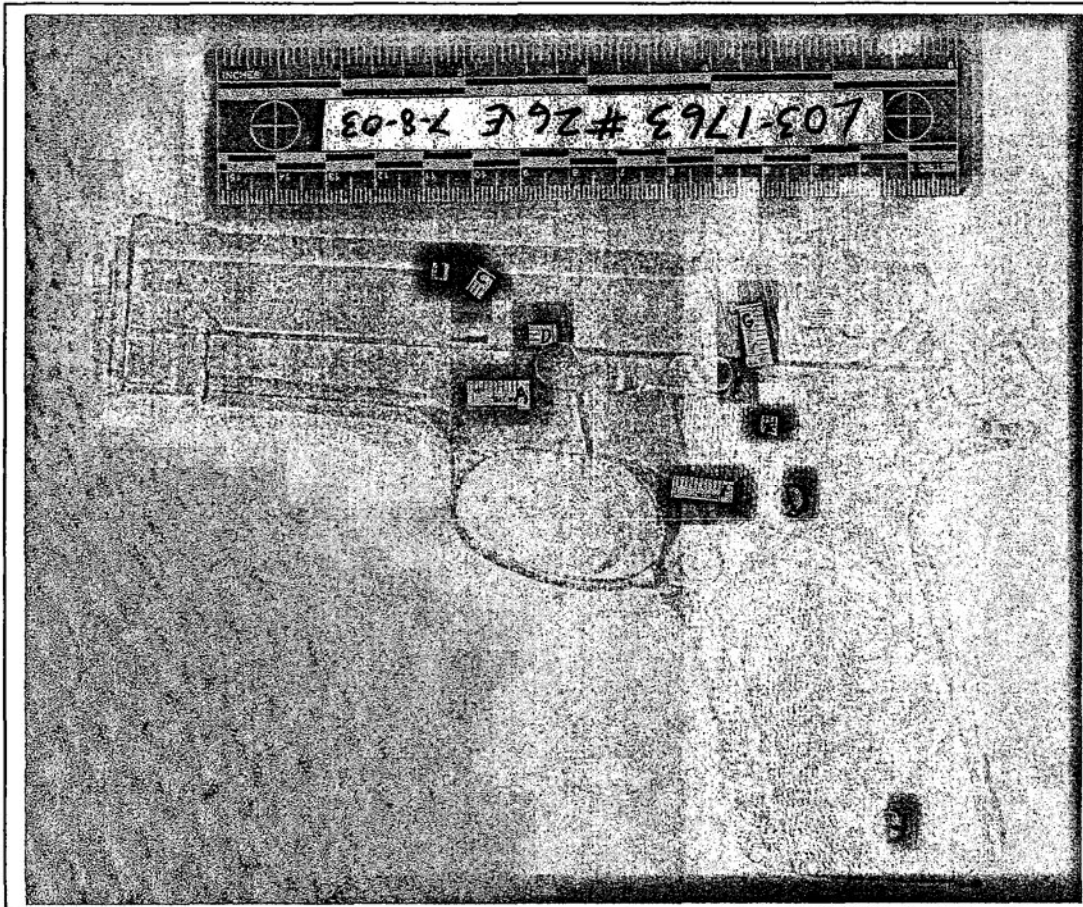

Photo 1: Left side of 9mm pistol. Stickers with letters "A" through "G" have mm marks pointing toward blood spatter(s) smaller than 1.0 mm.



COUNTY OF VENTURA SHERIFF'S DEPARTMENT

800 S. VICTORIA AVENUE VENTURA, CA 93009 (805) 654-2370
FORENSIC SCIENCES LABORATORY REPORT

LAB CASE NUMBER
L03-1763

SUBJECT(S):	
SUSPECT:	PEARLMAN, NANCY
VICTIM:	STEPHENS
VICTIM:	CERIO
AGENCY:	
VENTURA COUNTY SHERIFF'S DEPARTMENT	
Attn: Sgt. Ernie Montagna Major Crimes	
AGENCY CASE NUMBER:	OFFENSE(S)
03-08235	INCIDENT, OFFICER INVOLVED

TRACE SECTION

EVIDENCE: On July 29, 2003 the following items were received from property:

Item 023 – (agency item 1) pieces of colorless and amber lens reportedly from near photo marker 1.

Item 038 – (agency item 16) the front passenger side signal assembly reportedly from unit 3338.

Item 040 – (agency item 18) the front passenger side fender reportedly from unit 3338. This item was briefly examined, but not used for purposes of this report.

OBJECTIVE: Determine if the pieces of lens in item 023 were originally part of the signal assembly in item 038.

RESULTS: The following is a summary of the analytic findings:

The pieces of lens in item 023 physically fit together to form most of a turn signal lens. The largest piece of lens in item 023 physically fits with a portion of plastic lens remaining on the signal assembly, item 038, to form one unit.

CONCLUSION:

Item 023 and item 038 were once connected to form a single passenger side signal assembly.

DISPOSITION OF EVIDENCE:

Evidence was returned to the original packaging.

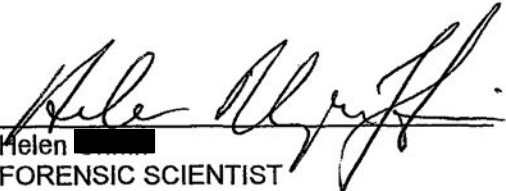
Helen [redacted]
FORENSIC SCIENTIST
08/07/2003



COUNTY OF VENTURA SHERIFF'S DEPARTMENT

800 S. VICTORIA AVENUE VENTURA, CA 93009 (805) 654-2370
FORENSIC SCIENCES LABORATORY REPORT

LAB CASE NUMBER
L03-1763

SUBJECT'(S):

SUSPECT: PEARLMAN, NANCY
VICTIM: STEPHENS
VICTIM: CERIO

AGENCY:

VENTURA COUNTY SHERIFF DEPARTMENT

Attn.: Sgt. Montagna

AGENCY CASE NUMBER:
03-08235

OFFENSE (S)
INCIDENT, OFFICER INVOLVED
417 P.C.

FIREARMS SECTION

GENERAL: On March 21, 2003 the location at Mugu Beach was examined. The [REDACTED] bearing California [REDACTED] was examined there and in the presence of Ian [REDACTED] at the laboratory on March 26, 2003.

On June 25, 2003 the following items were received from the Property Room:

- 009 One sealed envelope containing one box containing one bullet.
- 024 One sealed paper bag containing seven sealed envelopes (024A through 024G)
 - 024A One sealed envelope containing one box containing one discharged 9mm caliber Speer brand cartridge case.
 - 024B One sealed envelope containing one box containing one discharged 9mm caliber Speer brand cartridge case.
 - 024C One sealed envelope containing one box containing one discharged 9mm caliber Speer brand cartridge case.
 - 024D One sealed envelope containing one box containing one discharged 9mm caliber Speer brand cartridge case.
 - 024E One sealed envelope containing one box containing one discharged 9mm caliber Speer brand cartridge case.
 - 024F One sealed envelope containing one box containing one discharged 9mm caliber Speer brand cartridge case.
 - 024G One sealed envelope containing one box containing one discharged 9mm caliber Speer brand cartridge case.
- 027 One sealed envelope containing one live 9mm caliber Winchester brand cartridge and one loaded pistol magazine containing 11 live 9mm caliber Winchester brand cartridges and one live 9mm caliber Federal brand cartridge.
- 031 One sealed box labeled "Cero's Weapon" containing one 9mm caliber [REDACTED]
- 032 One sealed box labeled "Stevens' Weapon" containing one 9mm caliber [REDACTED]
- 033 One sealed envelope labeled "Ceros Spare Mags (2)" containing two Sig Sauer Magazines each containing 15 live 9mm caliber Speer brand cartridges.

- 034 One sealed envelope labeled "Cerio's Mag (Hot) Removed from weapon" containing one loose live 9mm caliber Speer brand cartridge and one Sig Sauer brand magazine containing twelve live 9mm caliber Speer brand cartridges.

On June 26 the following items of evidence were received from the property room:

- 035 One sealed envelope labeled "2 magazines from unit # 3415 (vehicle) containing two Sig Sauer brand magazines each containing 15 live 9mm caliber Speer brand cartridges.
- 036 One sealed envelope labeled "Stephens' mag. (hot) removed from weapon" containing one loose live 9mm caliber Speer brand cartridge and one Sig Sauer brand magazine containing ten live 9mm caliber Speer brand cartridges.
- 037 One sealed envelope labeled "Stevens' Spare Mags (2)" containing two Sig Sauer brand Magazines each containing fifteen live 9mm caliber Speer brand cartridges.

On July 14, 2003 the following item of evidence was received from Forensic Scientist Edwin [REDACTED]

- 026 One box containing one [REDACTED] and two laboratory envelopes (not examined).

OBJECTIVE: Determine the trajectory of the shots fired. Determine if the pistol, item #026, is operable. Determine what firearm the cartridge cases, item #024, were fired in. Determine what firearm the bullet, item #009, was fired from. Test the ejection pattern of the Sig Sauer pistols, items #031 and #032.

RESULTS: The following is a summary of the analytic findings:

The [REDACTED] exhibits an entry bullet hole (outside to inside of the car) near the back of the driver's window, this is the first entry into the window. The window also exhibits two other holes where fragmented glass has fallen or was driven out. One hole is near the bullet hole and exhibits additional chipping; the second hole is on the lower edge of the glass toward the front of the window and exhibits clear edges. The window on the passenger side exhibits a bullet exit hole (inside to out) at the front edge of a large missing area. The trajectory connecting this to the two rear holes near the rear of the drivers side window exhibits a bullet path that is basically from the left side of the car to the right, slightly back to front and slightly upward. The driver was still seated in the front left seat and was seen to exhibit a hole on the left side of the face near the outer corner of left eye. It would be difficult for the bullet entering the driver's side window bullet entry hole to pass out the exit hole in the passenger window with the driver in a normal driving position. A bullet entering the area left by the hole just ahead of the bullet entry hole could more easily exit the bullet exit in the passenger window without striking the driver.

A Smith & Wesson semiautomatic pistol was resting against the driver with the muzzle forward and the slide downward. As recovered, the hammer was down, the safety was off, both the chamber and magazine were loaded. I unloaded the pistol and placed the magazine and the round from the chamber into an envelope and placed the envelope and firearm in a bag, which was retained by BI personnel. The hammer was lowered using the pistols safety.

The right front tire exhibits a bullet entry on the sidewall near the "L" in "Wrangler" and an exit on the tread surface. The right front rim exhibits a bullet strike that tests positive for lead. The right rear tire exhibits a bullet entry on the side wall near the "D" in "Goodyear" and an exit on the tread surface. The left rear rim exhibits traffic accident like damage and two areas of bullet strike damage that test positive for lead.

Cartridge case positions were observed within the crime scene. All measurements and photographs of the scene and car were taken by other personnel. Additional analysis will be the subject of an additional report.

The Smith & Wesson pistol #026 was examined, test fired and found to be in poor operating condition. The safety was frozen in the off position as received from Edwin [REDACTED], however, it was operable on March 21, 2003 when I unloaded the firearm. The firearm fired when tested. The safety is rusted in place. The magazine of item #027 was use in testing the pistol.

The Sig Sauer pistols, #031 and #032 were found to be in normal operating condition. See the attached charts for ejection patterns. The magazines of items #034 and #036, respectively, were use in testing the pistols.

The bullet, item 009, was fired from the Sig Sauer pistol #032.

The cartridge cases, items #024A through #024D were fired in the Sig Sauer pistol #032. The cartridge cases, items #024E through #024G were fired in the Sig Sauer pistol #031.

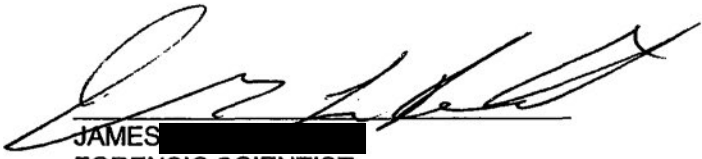

JAMES [REDACTED]
FORENSIC SCIENTIST
7/16/2003

Attachments

L03-1763 Item 31

shot #	first strike		final position	
	X (distance to rear)	Y (distance to right)	X (distance to rear)	Y (distance to right)
1	46	53	55	71
2	46	49	63	59
3	29	30	52	12
4	26	35	32	53
5	36	67	53	84
6	53	66	46	93
7	31	41	39	57
8	32	56	36	43
9	29	58	10	84
10	38	44	54	93

L03-1763 Item 31
Ejection Pattern

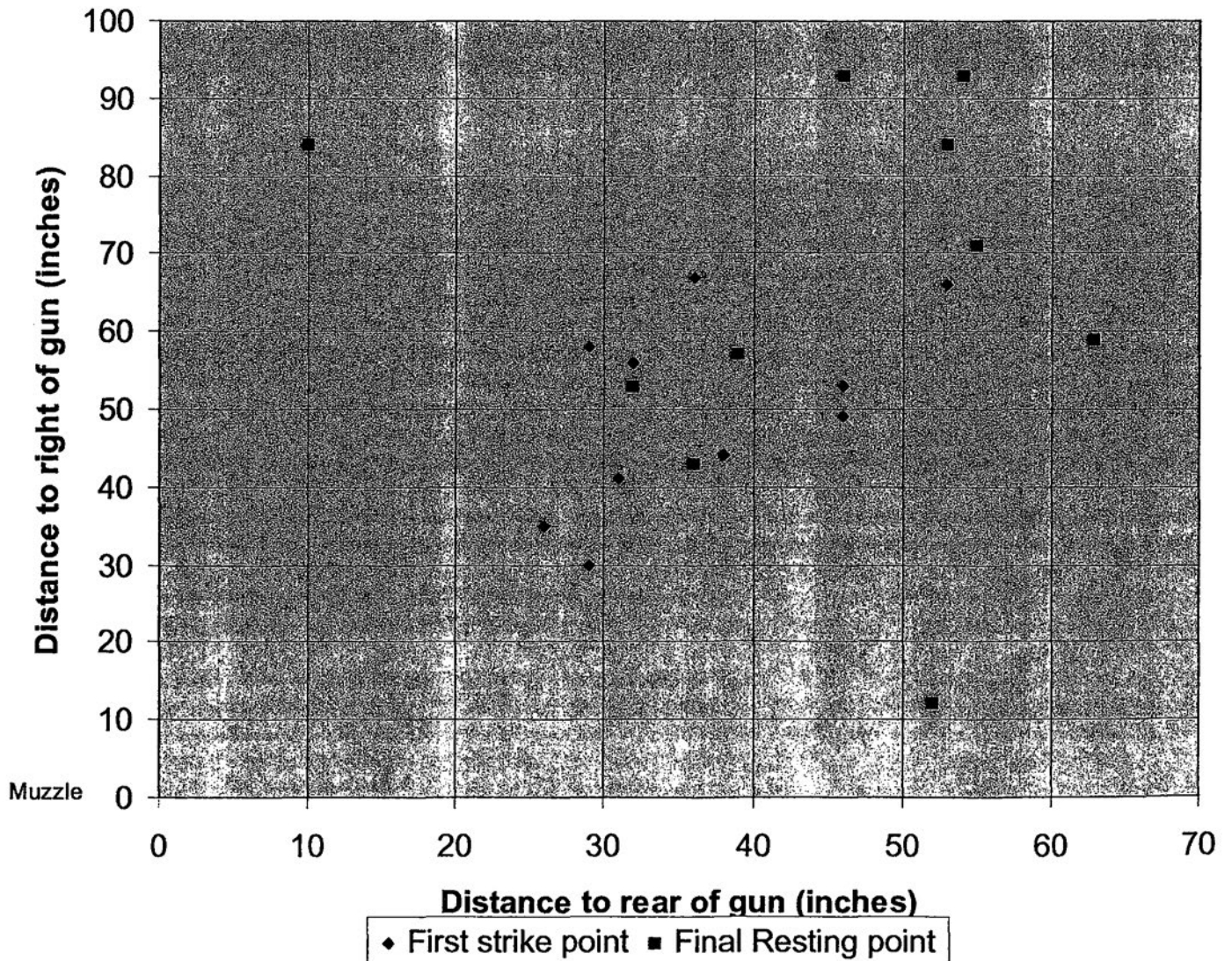

Shot #	L03-1763 (inches)		Item 32	
	first strike X (distance to rear)	Y (distance to right)	final position X (distance to rear)	Y (distance to right)
1	35	36	38	22
2	37	53	45	60
3	32	53	48	73
4	40	53	72	61
5	28	45	37	63
6	23	54	3	105
7	37	57	51	64
8	27	69	20.5	68
9	24	50	33	40
10	32	44	68	66

**L03-1763 Item 32
Ejection Pattern**

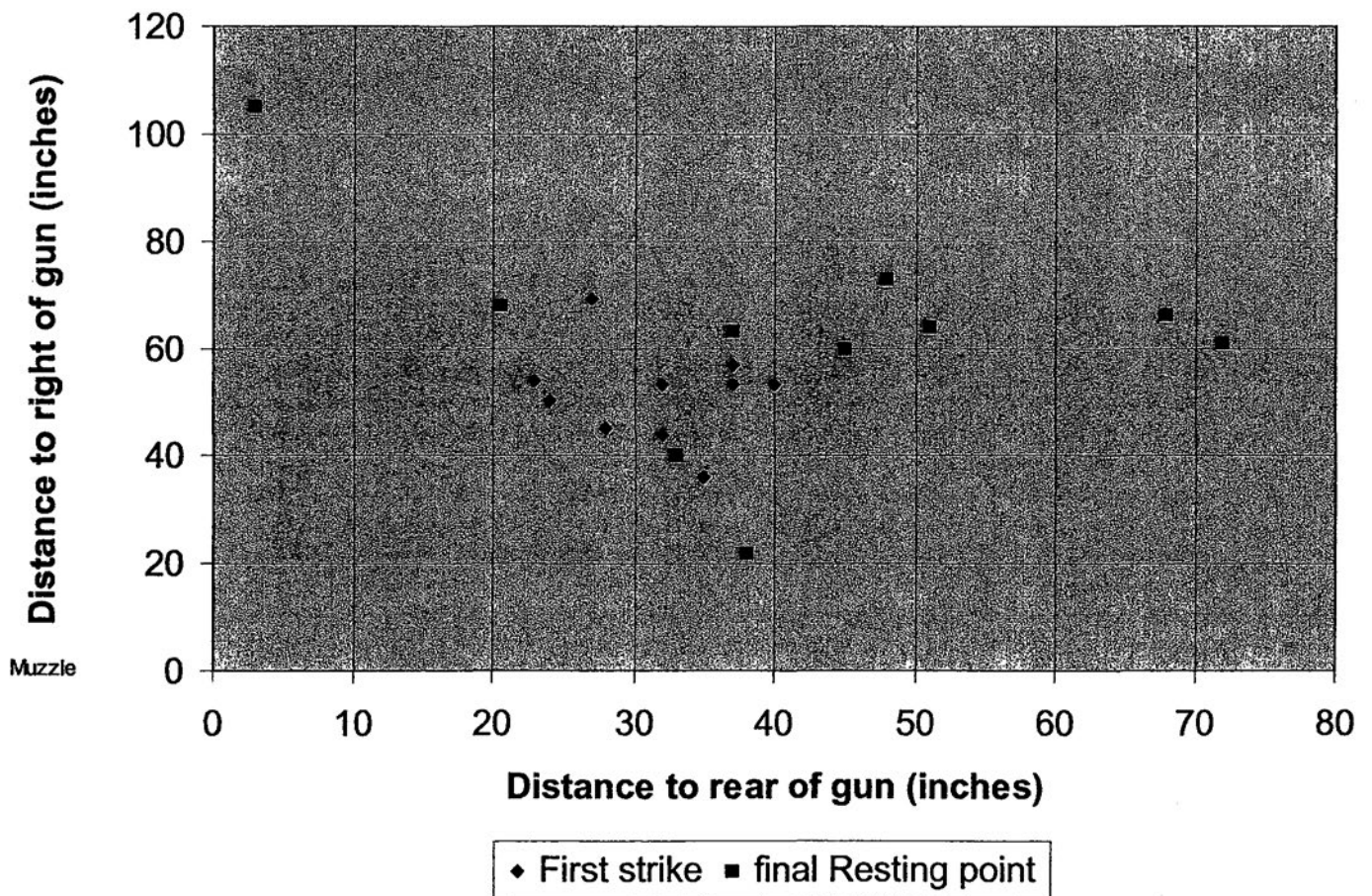



COUNTY OF VENTURA SHERIFF'S DEPARTMENT

800 S. VICTORIA AVENUE VENTURA, CA 93009 (805) 654-2370
FORENSIC SCIENCES LABORATORY REPORT

LAB CASE NUMBER
L03-1763

SUBJECT'(S):	
SUSPECT:	PEARLMAN, NANCY
VICTIM:	STEPHENS
VICTIM:	CERIO
AGENCY:	
VENTURA COUNTY SHERIFF DEPARTMENT	
Attn: DET. MONTAGNA	
AGENCY CASE NUMBER:	OFFENSE (S)
03-08235	INCIDENT, OFFICER INVOLVED

TRACE SECTION

EVIDENCE: On 6/27/2003 the following item was received from Forensic Scientist Helen [REDACTED]

026 - One 9 X 19 MM (LUGER) caliber [REDACTED]

Photographs of crime scene and autopsy.

OBJECTIVE: Blood stain pattern analysis.

RESULTS:

1. A stain pattern consisting of 18 reddish brown spatters (each smaller than 1 mm) was observed on the left side of the pistol item 26. See Photo 1. Six of these reddish brown spatters gave a positive presumptive test for blood. The other 12 spatters were not tested. This pattern extends approximately 3" from above the leading edge of the trigger guard "B" in Photo 1 to under the safety "G" and down to the top of the top of the trigger guard area on the grip "F". This bloodstain pattern is consistent with a blowback from a bullet entering a part of the head not covered with hair.
2. When the pistol item 26 is held with the grip in the right hand, the bloodstain pattern is not obscured. When the pistol is held with the grip in the left hand, blood spatter "F" (see Photo1) and possibly blood spatter "E" from the pistol grip are obscured by the left hand. In other words when the pistol is held in a normal manner (hand around grip and forefinger on trigger) it could have been held in the right hand and could not be held in the left hand when the blood pattern was deposited.
3. Examination of crime scene photograph 33N05931 shows the deceased subject strapped into the drivers seat and the 9mm Model 59 (item 26) on the seat beside her with the barrel on the seat and the bottom of the grip (butt end) leaning against her left forearm near the elbow. A red (obvious blood impression) straight-line mark is present on her forearm just in front of the area where the pistol butt is touching her left forearm. The bottom of the grip that was then repositioned into its current position probably caused this straight-line bloody imprint. In other words the pistol was in a position approximately 1 inch forward (closer to the wrist) before it was moved. Blood began to flow down the left side of the subject almost immediately after the bullet wound to the eye. The pistol had to be in a position to be touched by that blood flow (there was a blood flow present on the outside of the left grip as well as inside the grip where the magazine would normally reside). The straight-line mark on the forearm would mark this original location. The pistol had to get in this position quickly to have blood flow down the grip. In other words it could not have been on the subject's lap when the bullet entered the subject's eye.

4. Examination of autopsy photograph 33L05795 shows numerous injuries from secondary projectiles (flying glass from gun shots through driver's side window) on the left side of the subject's face and neck, left shoulder, web of right hand, right forearm (just above wrist) and on the front surface of the middle finger of the right hand above the finger-hand joint and below the first finger joint. The injury to the middle finger is also visible on autopsy photograph 33L05786. By shifting the grip on the pistol, the flying glass injuries to the web of the right hand can be shielded by the pistol or not shielded by the pistol. By changing the angle of the wrist, the direction that the pistol is pointed will change. These injuries are consistent with the subject pointing the pistol with her right hand at the inside of the driver's window when one or both bullets penetrated the driver's window creating a spray of secondary glass projectiles.

CONCLUSION:

Examination and analysis of the blood spatter pattern on the pistol item 26, the crime scene photographs and the autopsy photographs shows that the evidence is consistent with the subject pointing the pistol at the inside of the driver's door window when she was shot in the left eye.

REMARK:

Examination of photograph 33N05932 shows evidence that the pistol item 26 was most likely moved before this photograph was taken.

Edwin L. Jones Jr

Edwin [REDACTED]
Forensic Scientist
8/13/2003

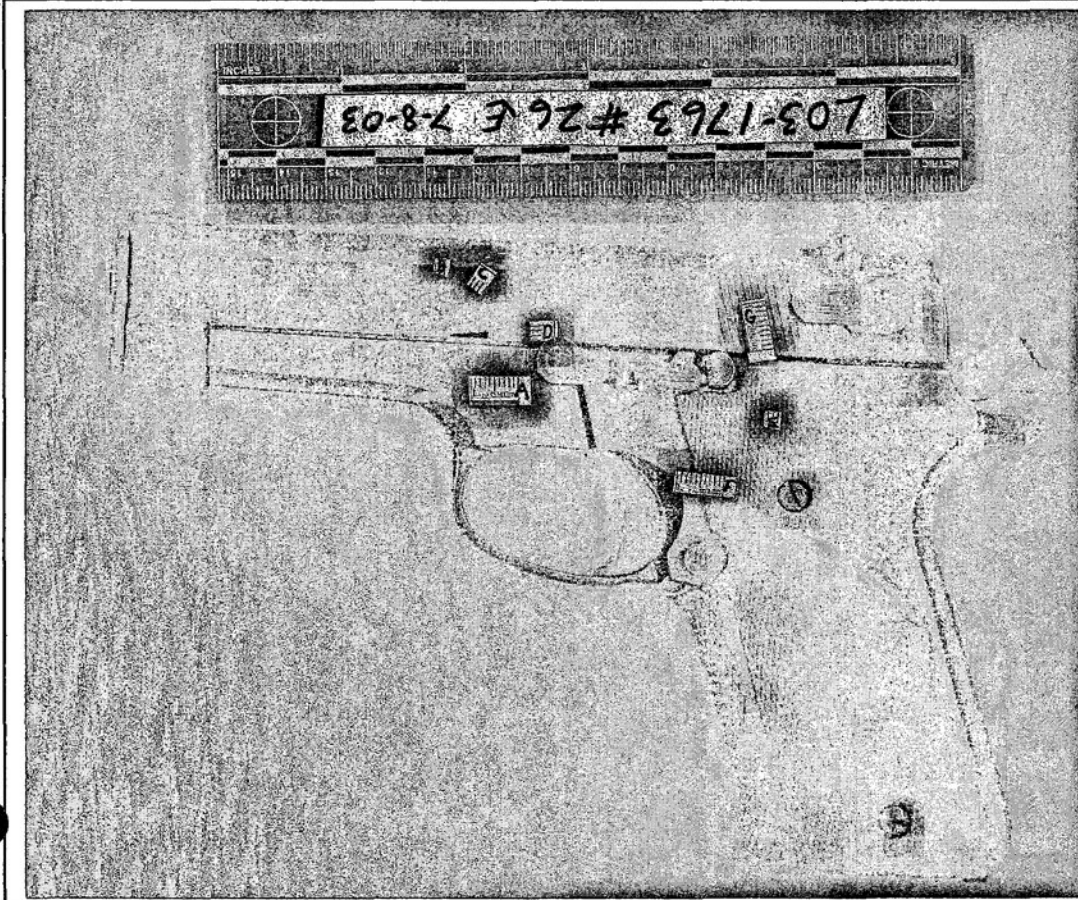

Photo 1: Left side of 9mm pistol. Stickers with letters "A" through "G" have mm marks pointing toward blood spatter(s) smaller than 1.0 mm.



COUNTY OF VENTURA SHERIFF'S DEPARTMENT

800 S. VICTORIA AVENUE VENTURA, CA 93009 (805) 654-2370
FORENSIC SCIENCES LABORATORY REPORT

**LAB CASE
NUMBER
L03-1763**

SUBJECT(S): SUSPECT: PEARLMAN, NANCY VICTIM: STEPHENS VICTIM: CERIO	
AGENCY: VENTURA COUNTY SHERIFF'S DEPARTMENT	
Attn: Sgt. Ernie Montagna Major Crimes	
AGENCY CASE NUMBER: 03-08235	OFFENSE(S) INCIDENT, OFFICER INVOLVED

TRACE SECTION

EVIDENCE: On June 11, 2003 the following item was received from property:

026 - (agency item 4) a 9mm Smith & Wesson Model 59 gun.

OBJECTIVE: Collect glass from the gun, item 026.

RESULTS: The following is a summary of the analytic findings:

The gun was examined for fragments with a stereomicroscopic (approximately 7.5 times magnification) appearance of glass. Colorless fragments were collected from fifteen different areas on the gun. These fragments were collected from most of the exposed surfaces of the gun. No fragments were recovered from inside of the barrel.

Fragments were also collected from the magazine, item 027, while in the custody of Jim [REDACTED].

While examining the gun for glass fragments, fine red- [REDACTED] spatter was noted in the area of the "SMITH & WESSON" on the slide. The gun was turned over to forensic scientist Ed [REDACTED] for possible blood spatter interpretation.

COMMENTS:

During examination of the gun, item 026, it was not determined which of the collected fragments were deposited directly onto the gun from the window and which fragments became associated with the gun from contact with glass on the driver's seat and/or from handling.

DISPOSITION OF EVIDENCE:

The colorless fragments collected from the gun, item 026, and magazine, item 027, were placed onto post-it notes in plastic bags and returned to the original items.

Helen [REDACTED]
FORENSIC SCIENTIST
06/27/2003



COUNTY OF VENTURA SHERIFF'S DEPARTMENT

800 S. VICTORIA AVENUE VENTURA, CA 93009 (805) 654-2370
FORENSIC SCIENCES LABORATORY REPORT

LAB CASE NUMBER
L03-1763

SUBJECT(S):

SUSPECT: PEARLMAN, NANCY
VICTIM: STEPHENS
VICTIM: CERIO

AGENCY:

VENTURA COUNTY SHERIFF DEPARTMENT

Attn.: Sgt. Montagna

AGENCY CASE NUMBER:
03-08235

OFFENSE (S)
INCIDENT, OFFICER INVOLVED
417 P.C.

FIREARMS SECTION

GENERAL: On March 21, 2003 the location at Mugu Beach was examined. The [REDACTED] bearing California [REDACTED] was examined there and in the presence of Ian [REDACTED] at the laboratory on March 26, 2003.

On June 25, 2003 the following items were received from the Property Room:

- 009 One sealed envelope containing one box containing one bullet.
- 024 One sealed paper bag containing seven sealed envelopes (024A through 024G)
 - 024A One sealed envelope containing one box containing one discharged 9mm caliber Speer brand cartridge case.
 - 024B One sealed envelope containing one box containing one discharged 9mm caliber Speer brand cartridge case.
 - 024C One sealed envelope containing one box containing one discharged 9mm caliber Speer brand cartridge case.
 - 024D One sealed envelope containing one box containing one discharged 9mm caliber Speer brand cartridge case.
 - 024E One sealed envelope containing one box containing one discharged 9mm caliber Speer brand cartridge case.
 - 024F One sealed envelope containing one box containing one discharged 9mm caliber Speer brand cartridge case.
 - 024G One sealed envelope containing one box containing one discharged 9mm caliber Speer brand cartridge case.
- 027 One sealed envelope containing one live 9mm caliber Winchester brand cartridge and one loaded pistol magazine containing 11 live 9mm caliber Winchester brand cartridges and one live 9mm caliber Federal brand cartridge.
- 031 One sealed box labeled "Cero's Weapon" containing one 9mm caliber [REDACTED]
- 032 One sealed box labeled "Stevens' Weapon" containing one 9mm caliber [REDACTED]
- 033 One sealed envelope labeled "Ceros Spare Mags (2)" containing two Sig Sauer Magazines each containing 15 live 9mm caliber Speer brand cartridges.

- 034 One sealed envelope labeled "Cerio's Mag (Hot) Removed from weapon" containing one loose live 9mm caliber Speer brand cartridge and one Sig Sauer brand magazine containing twelve live 9mm caliber Speer brand cartridges.

On June 26 the following items of evidence were received from the property room:

- 035 One sealed envelope labeled "2 magazines from unit # 3415 (vehicle) containing two Sig Sauer brand magazines each containing 15 live 9mm caliber Speer brand cartridges.
- 036 One sealed envelope labeled "Stephens' mag. (hot) removed from weapon" containing one loose live 9mm caliber Speer brand cartridge and one Sig Sauer brand magazine containing ten live 9mm caliber Speer brand cartridges.
- 037 One sealed envelope labeled "Stevens' Spare Mags (2)" containing two Sig Sauer brand Magazines each containing fifteen live 9mm caliber Speer brand cartridges.

On July 14, 2003 the following item of evidence was received from Forensic Scientist Edwin [REDACTED]:

- 026 One box containing one [REDACTED] and two laboratory envelopes (not examined).

OBJECTIVE: Determine the trajectory of the shots fired. Determine if the pistol, item #026, is operable. Determine what firearm the cartridge cases, item #024, were fired in. Determine what firearm the bullet, item #009, was fired from. Test the ejection pattern of the Sig Sauer pistols, items #031 and #032.

RESULTS: The following is a summary of the analytic findings:

The [REDACTED] exhibits an entry bullet hole (outside to inside of the car) near the back of the driver's window, this is the first entry into the window. The window also exhibits two other holes where fragmented glass has fallen or was driven out. One hole is near the bullet hole and exhibits additional chipping; the second hole is on the lower edge of the glass toward the front of the window and exhibits clear edges. The window on the passenger side exhibits a bullet exit hole (inside to out) at the front edge of a large missing area. The trajectory connecting this to the two rear holes near the rear of the drivers side window exhibits a bullet path that is basically from the left side of the car to the right, slightly back to front and slightly upward. The driver was still seated in the front left seat and was seen to exhibit a hole on the left side of the face near the outer corner of left eye. It would be difficult for the bullet entering the driver's side window bullet entry hole to pass out the exit hole in the passenger window with the driver in a normal driving position. A bullet entering the area left by the hole just ahead of the bullet entry hole could more easily exit the bullet exit in the passenger window without striking the driver.

A Smith & Wesson semiautomatic pistol was resting against the driver with the muzzle forward and the slide downward. As recovered, the hammer was down, the safety was off, both the chamber and magazine were loaded. I unloaded the pistol and placed the magazine and the round from the chamber into an envelope and placed the envelope and firearm in a bag, which was retained by BI personnel. The hammer was lowered using the pistols safety.

The right front tire exhibits a bullet entry on the sidewall near the "L" in "Wrangler" and an exit on the tread surface. The right front rim exhibits a bullet strike that tests positive for lead. The right rear tire exhibits a bullet entry on the side wall near the "D" in "Goodyear" and an exit on the tread surface. The left rear rim exhibits traffic accident like damage and two areas of bullet strike damage that test positive for lead.

Cartridge case positions were observed within the crime scene. All measurements and photographs of the scene and car were taken by other personnel. Additional analysis will be the subject of an additional report.

The Smith & Wesson pistol #026 was examined, test fired and found to be in poor operating condition. The safety was frozen in the off position as received from Edwin [REDACTED], however, it was operable on March 21, 2003 when I unloaded the firearm. The firearm fired when tested. The safety is rusted in place. The magazine of item #027 was use in testing the pistol.

The Sig Sauer pistols, #031 and #032 were found to be in normal operating condition. See the attached charts for ejection patterns. The magazines of items #034 and #036, respectively, were use in testing the pistols.

The bullet, item 009, was fired from the Sig Sauer pistol #032.

The cartridge cases, items #024A through #024D were fired in the Sig Sauer pistol #032. The cartridge cases, items #024E through #024G were fired in the Sig Sauer pistol #031.

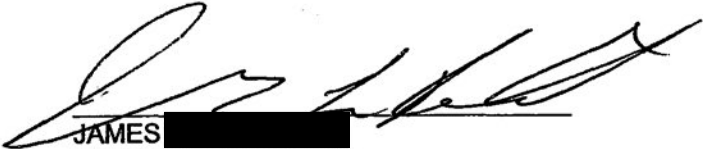

JAMES [REDACTED]
FORENSIC SCIENTIST
7/16/2003

Attachments

L03-1763 Item 31

shot #	first strike		final position	
	X (distance to rear)	Y (distance to right)	X (distance to rear)	Y (distance to right)
1	46	53	55	71
2	46	49	63	59
3	29	30	52	12
4	26	35	32	53
5	36	67	53	84
6	53	66	46	93
7	31	41	39	57
8	32	56	36	43
9	29	58	10	84
10	38	44	54	93

L03-1763 Item 31
Ejection Pattern

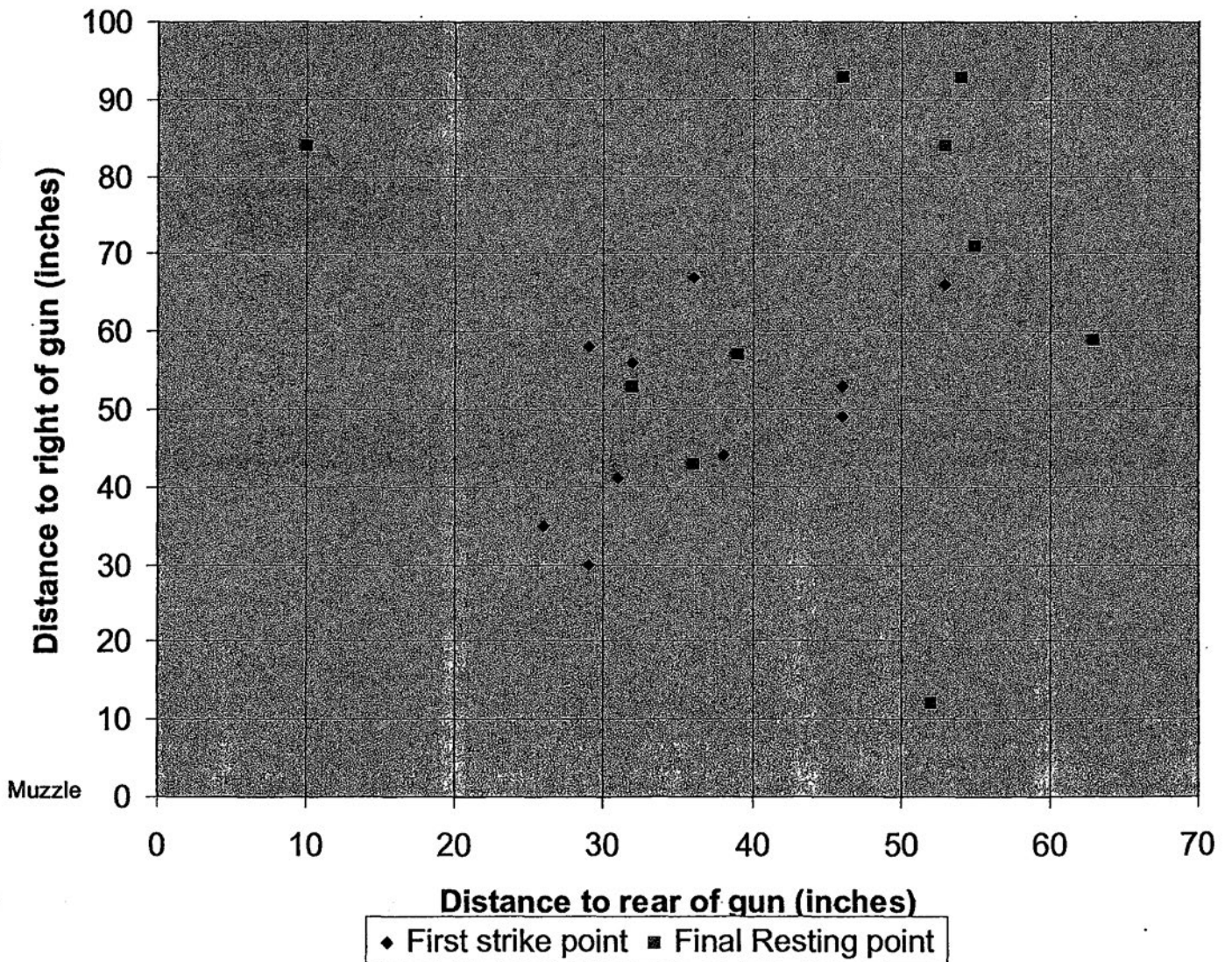

Shot #	L03-1763 (inches)		Item 32	
	first strike X (distance to rear)	Y (distance to right)	final position X (distance to rear)	Y (distance to right)
1	35	36	38	22
2	37	53	45	60
3	32	53	48	73
4	40	53	72	61
5	28	45	37	63
6	23	54	3	105
7	37	57	51	64
8	27	69	20.5	68
9	24	50	33	40
10	32	44	68	66

**L03-1763 Item 32
Ejection Pattern**

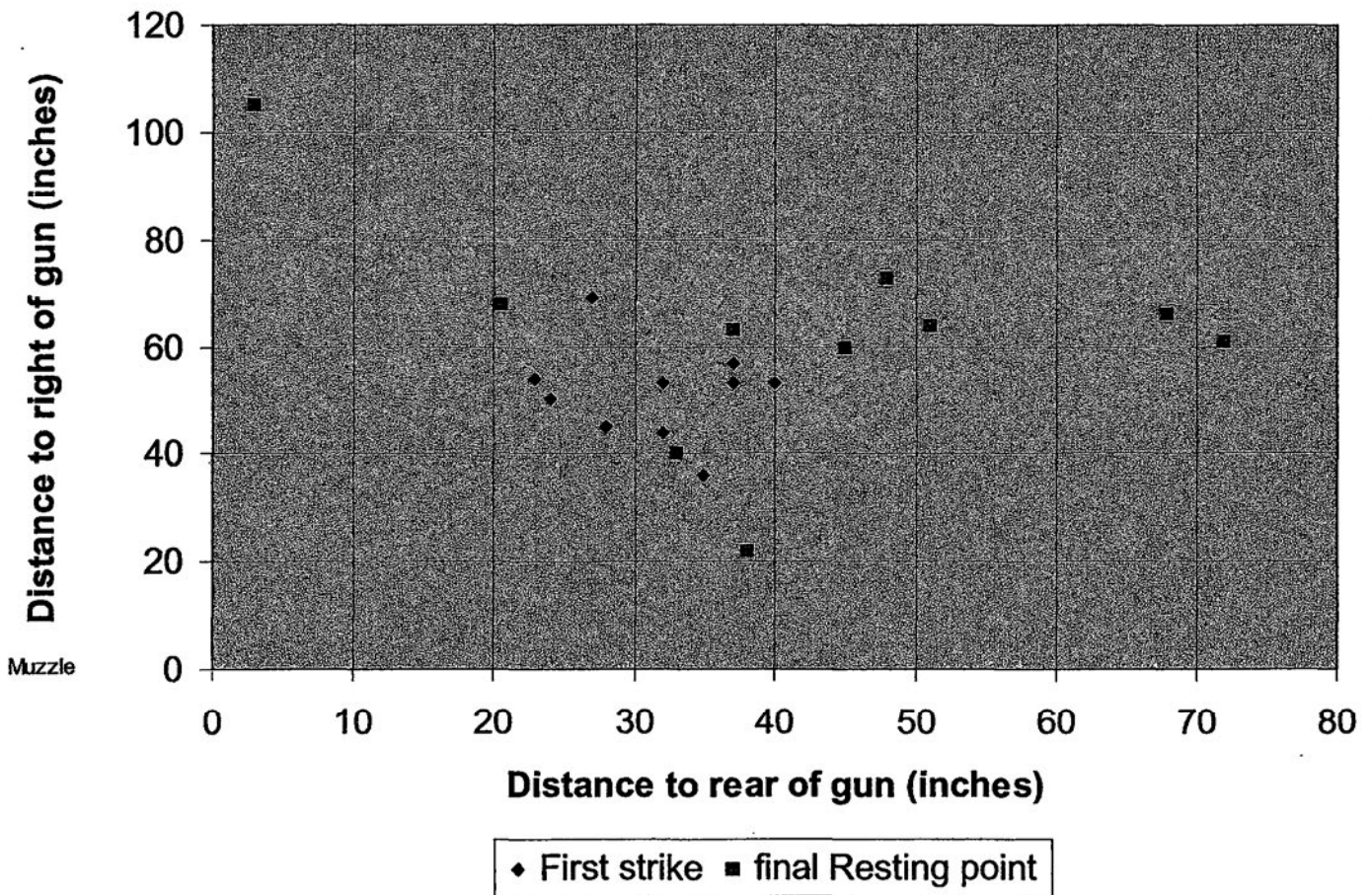

REVIEWED BY: TR 7-18-03 ✓ AR 7-18-03 ✓



COUNTY OF VENTURA SHERIFF'S DEPARTMENT

800 S. VICTORIA AVENUE VENTURA, CA 93009 (805) 654-2370
FORENSIC SCIENCES LABORATORY REPORT

LAB CASE NUMBER
L03-1763

SUBJECT(S):

SUSPECT: PEARLMAN, NANCY
VICTIM: STEPHENS
VICTIM: CERIO

AGENCY:

VENTURA COUNTY SHERIFF DEPARTMENT

Attn.: Sgt. Montagna

AGENCY CASE NUMBER:
03-08235

OFFENSE (S)
INCIDENT, OFFICER INVOLVED
417 P.C.

FIREARMS SECTION

GENERAL: On March 21, 2003 the location at Mugu Beach was examined. The Chevrolet [REDACTED] bearing California [REDACTED] was examined there and in the presence of Ian [REDACTED] at the laboratory on March 26, 2003.

On June 25, 2003 the following items were received from the Property Room:

- 009 One sealed envelope containing one box containing one bullet.
- 024 One sealed paper bag containing seven sealed envelopes (024A through 024G)
 - 024A One sealed envelope containing one box containing one discharged 9mm caliber Speer brand cartridge case.
 - 024B One sealed envelope containing one box containing one discharged 9mm caliber Speer brand cartridge case.
 - 024C One sealed envelope containing one box containing one discharged 9mm caliber Speer brand cartridge case.
 - 024D One sealed envelope containing one box containing one discharged 9mm caliber Speer brand cartridge case.
 - 024E One sealed envelope containing one box containing one discharged 9mm caliber Speer brand cartridge case.
 - 024F One sealed envelope containing one box containing one discharged 9mm caliber Speer brand cartridge case.
 - 024G One sealed envelope containing one box containing one discharged 9mm caliber Speer brand cartridge case.
- 027 One sealed envelope containing one live 9mm caliber Winchester brand cartridge and one loaded pistol magazine containing 11 live 9mm caliber Winchester brand cartridges and one live 9mm caliber Federal brand cartridge.
- 031 One sealed box labeled "Cero's Weapon" containing one 9mm caliber [REDACTED]
- 032 One sealed box labeled "Stevens' Weapon" containing one 9mm caliber [REDACTED]
- 033 One sealed envelope labeled "Ceros Spare Mags (2)" containing two Sig Sauer Magazines each containing 15 live 9mm caliber Speer brand cartridges.

- 034 One sealed envelope labeled "Cerio's Mag (Hot) Removed from weapon" containing one loose live 9mm caliber Speer brand cartridge and one Sig Sauer brand magazine containing twelve live 9mm caliber Speer brand cartridges.

On June 26 the following items of evidence were received from the property room:

- 035 One sealed envelope labeled "2 magazines from unit # 3415 (vehicle) containing two Sig Sauer brand magazines each containing 15 live 9mm caliber Speer brand cartridges.
- 036 One sealed envelope labeled "Stephens' mag. (hot) removed from weapon" containing one loose live 9mm caliber Speer brand cartridge and one Sig Sauer brand magazine containing ten live 9mm caliber Speer brand cartridges.
- 037 One sealed envelope labeled "Stevens' Spare Mags (2)" containing two Sig Sauer brand Magazines each containing fifteen live 9mm caliber Speer brand cartridges.

On July 14, 2003 the following item of evidence was received from Forensic Scientist Edwin J. [REDACTED]

- 026 One box containing one [REDACTED] and two laboratory envelopes (not examined).

OBJECTIVE: Determine the trajectory of the shots fired. Determine if the pistol, item #026, is operable. Determine what firearm the cartridge cases, item #024, were fired in. Determine what firearm the bullet, item #009, was fired from. Test the ejection pattern of the Sig Sauer pistols, items #031 and #032.

RESULTS: The following is a summary of the analytic findings:

The [REDACTED] exhibits an entry bullet hole (outside to inside of the car) near the back of the driver's window, this is the first entry into the window. The window also exhibits two other holes where fragmented glass has fallen or was driven out. One hole is near the bullet hole and exhibits additional chipping; the second hole is on the lower edge of the glass toward the front of the window and exhibits clear edges. The window on the passenger side exhibits a bullet exit hole (inside to out) at the front edge of a large missing area. The trajectory connecting this to the two rear holes near the rear of the drivers side window exhibits a bullet path that is basically from the left side of the car to the right, slightly back to front and slightly upward. The driver was still seated in the front left seat and was seen to exhibit a hole on the left side of the face near the outer corner of left eye. It would be difficult for the bullet entering the driver's side window bullet entry hole to pass out the exit hole in the passenger window with the driver in a normal driving position. A bullet entering the area left by the hole just ahead of the bullet entry hole could more easily exit the bullet exit in the passenger window without striking the driver.

A Smith & Wesson semiautomatic pistol was resting against the driver with the muzzle forward and the slide downward. As recovered, the hammer was down, the safety was off, both the chamber and magazine were loaded. I unloaded the pistol and placed the magazine and the round from the chamber into an envelope and placed the envelope and firearm in a bag, which was retained by BI personnel. The hammer was lowered using the pistols safety.

The right front tire exhibits a bullet entry on the sidewall near the "L" in "Wrangler" and an exit on the tread surface. The right front rim exhibits a bullet strike that tests positive for lead. The right rear tire exhibits a bullet entry on the side wall near the "D" in "Goodyear" and an exit on the tread surface. The left rear rim exhibits traffic accident like damage and two areas of bullet strike damage that test positive for lead.

Cartridge case positions were observed within the crime scene. All measurements and photographs of the scene and car were taken by other personnel. Additional analysis will be the subject of an additional report.

The Smith & Wesson pistol #026 was examined, test fired and found to be in poor operating condition. The safety was frozen in the off position as received from Edwin [REDACTED], however, it was operable on March 21, 2003 when I unloaded the firearm. The firearm fired when tested. The safety is rusted in place. The magazine of item #027 was use in testing the pistol.

The Sig Sauer pistols, #031 and #032 were found to be in normal operating condition. See the attached charts for ejection patterns. The magazines of items #034 and #036, respectively, were use in testing the pistols.

The bullet, item 009, was fired from the Sig Sauer pistol #032.

The cartridge cases, items #024A through #024D were fired in the Sig Sauer pistol #032. The cartridge cases, items #024E through #024G were fired in the Sig Sauer pistol #031.

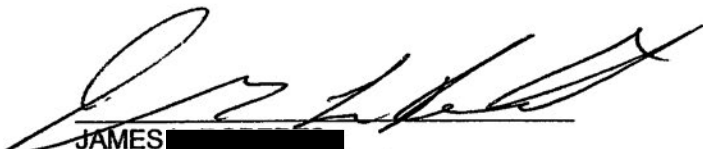

JAMES [REDACTED]
FORENSIC SCIENTIST
7/16/2003

Attachments

L03-1763 Item 31

shot #	first strike X (distance to rear)	Y (distance to right)	final position X (distance to rear)	Y (distance to right)
1	46	53	55	71
2	46	49	63	59
3	29	30	52	12
4	26	35	32	53
5	36	67	53	84
6	53	66	46	93
7	31	41	39	57
8	32	56	36	43
9	29	58	10	84
10	38	44	54	93

L03-1763 Item 31
Ejection Pattern

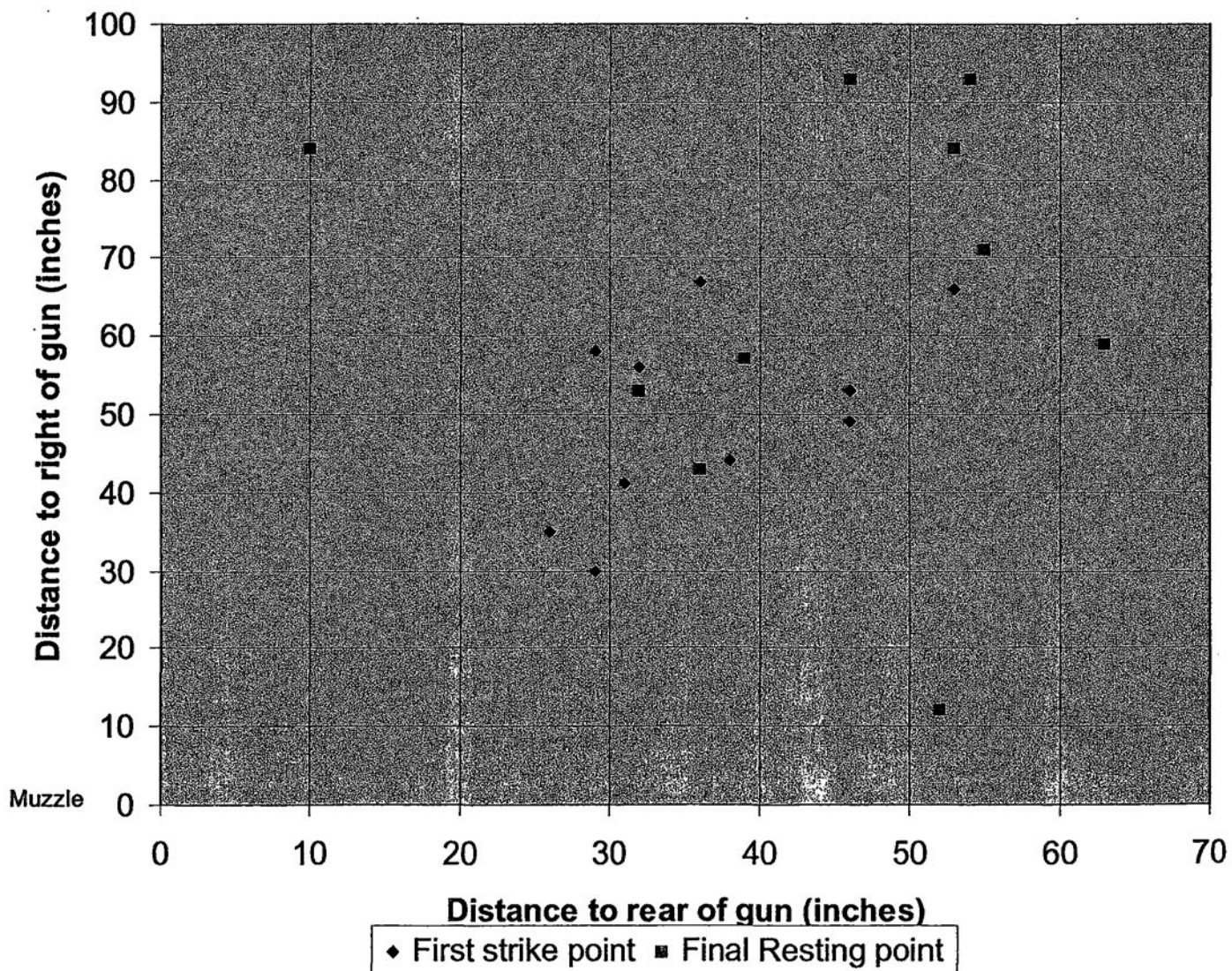

Shot #	L03-1763 (inches)		Item 32	
	first strike X (distance to rear)	Y (distance to right)	final position X (distance to rear)	Y (distance to right)
1	35	36	38	22
2	37	53	45	60
3	32	53	48	73
4	40	53	72	61
5	28	45	37	63
6	23	54	3	105
7	37	57	51	64
8	27	69	20.5	68
9	24	50	33	40
10	32	44	68	66

**L03-1763 Item 32
Ejection Pattern**

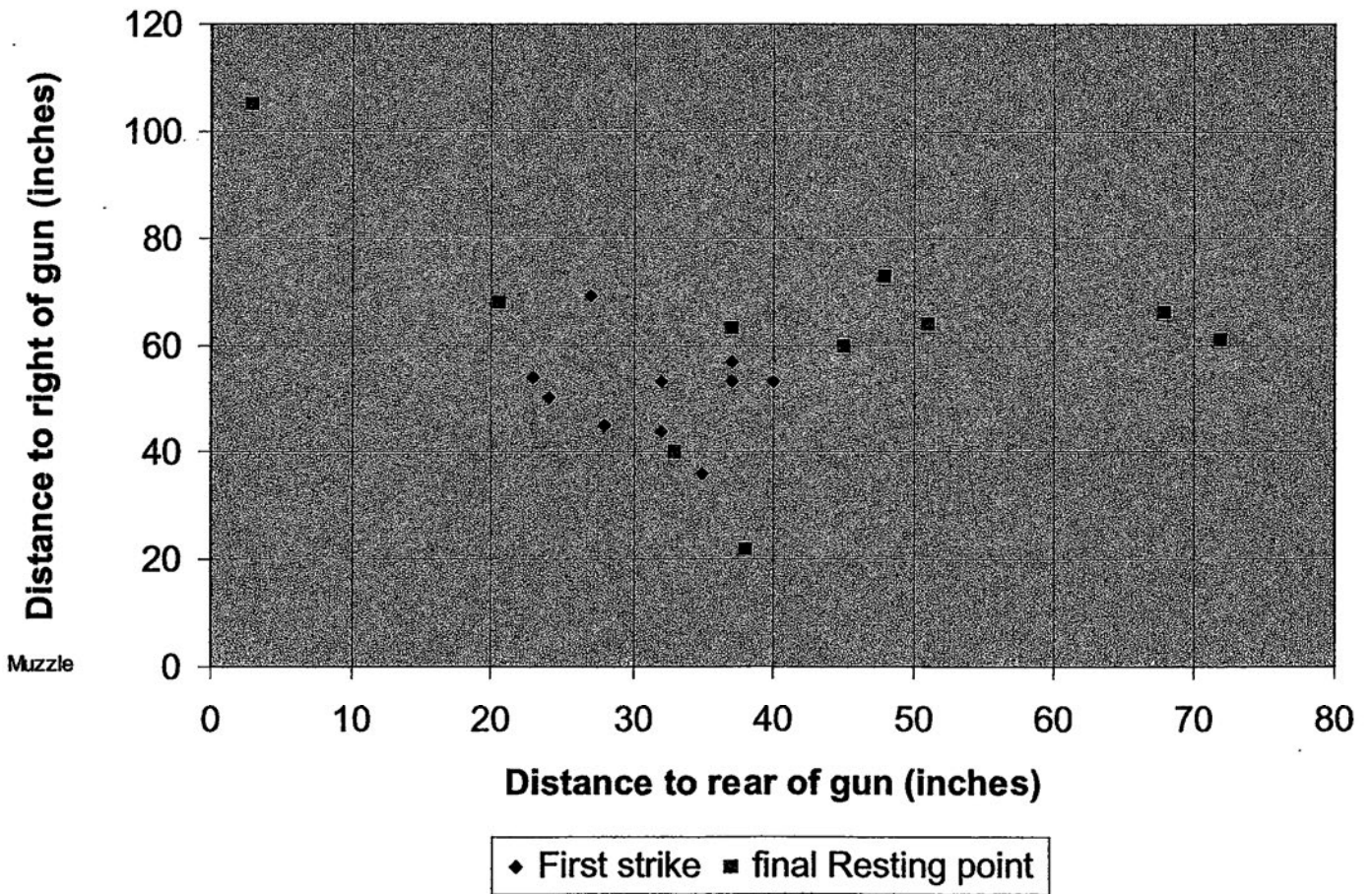



COUNTY OF VENTURA SHERIFF'S DEPARTMENT

800 S. VICTORIA AVENUE VENTURA, CA 93009 (805) 654-2370
FORENSIC SCIENCES LABORATORY REPORT

**LAB CASE
NUMBER
L03-1763**

SUBJECT(S): SUSPECT: PEARLMAN, NANCY VICTIM: STEPHENS VICTIM: CERIO	
AGENCY: VENTURA COUNTY SHERIFF'S DEPARTMENT Attn: Sgt. Ernie Montagna Major Crimes	
AGENCY CASE NUMBER: 03-08235	OFFENSE(S) INCIDENT, OFFICER INVOLVED

TRACE SECTION

EVIDENCE: On June 11, 2003 the following item was received from property:

026 - (agency item 4) a 9mm Smith & Wesson Model 59 gun.

OBJECTIVE: Collect glass from the gun, item 026.

RESULTS: The following is a summary of the analytic findings:

The gun was examined for fragments with a stereomicroscopic (approximately 7.5 times magnification) appearance of glass. Colorless fragments were collected from fifteen different areas on the gun. These fragments were collected from most of the exposed surfaces of the gun. No fragments were recovered from inside of the barrel.

Fragments were also collected from the magazine, item 027, while in the custody of [REDACTED].

While examining the gun for glass fragments, fine red-brown spatter was noted in the area of the "SMITH & WESSON" on the slide. The gun was turned over to forensic scientist [REDACTED] for possible blood spatter interpretation.

COMMENTS:

During examination of the gun, item 026, it was not determined which of the collected fragments were deposited directly onto the gun from the window and which fragments became associated with the gun from contact with glass on the driver's seat and/or from handling.

DISPOSITION OF EVIDENCE:

The colorless fragments collected from the gun, item 026, and magazine, item 027, were placed onto post-it notes in plastic bags and returned to the original items.



Helen [redacted]
FORENSIC SCIENTIST
06/27/2003



COUNTY OF VENTURA SHERIFF'S DEPARTMENT

800 S. VICTORIA AVENUE VENTURA, CA 93009 (805) 654-2370
FORENSIC SCIENCES LABORATORY REPORT

LAB CASE NUMBER
L03-1763

SUBJECT'(S):

SUSPECT: PEARLMAN, NANCY
VICTIM: STEPHENS
VICTIM: CERIO

AGENCY:

VENTURA COUNTY SHERIFF DEPARTMENT

Attn.: Sgt. Montagna

AGENCY CASE NUMBER:

03-08235

OFFENSE (S)

INCIDENT, OFFICER INVOLVED
417 P.C.

FIREARMS SECTION

GENERAL: On March 21, 2003 the location at Mugu Beach was examined. The [REDACTED] was examined there and in the presence of Ian [REDACTED] at the laboratory on March 26, 2003.

On June 25, 2003 the following items were received from the Property Room:

- 009 One sealed envelope containing one box containing one bullet.
- 024 One sealed paper bag containing seven sealed envelopes (024A through 024G)
 - 024A One sealed envelope containing one box containing one discharged 9mm caliber Speer brand cartridge case.
 - 024B One sealed envelope containing one box containing one discharged 9mm caliber Speer brand cartridge case.
 - 024C One sealed envelope containing one box containing one discharged 9mm caliber Speer brand cartridge case.
 - 024D One sealed envelope containing one box containing one discharged 9mm caliber Speer brand cartridge case.
 - 024E One sealed envelope containing one box containing one discharged 9mm caliber Speer brand cartridge case.
 - 024F One sealed envelope containing one box containing one discharged 9mm caliber Speer brand cartridge case.
 - 024G One sealed envelope containing one box containing one discharged 9mm caliber Speer brand cartridge case.
- 027 One sealed envelope containing one live 9mm caliber Winchester brand cartridge and one loaded pistol magazine containing 11 live 9mm caliber Winchester brand cartridges and one live 9mm caliber Federal brand cartridge.
- 031 One sealed box labeled "Cero's Weapon" containing one 9mm caliber [REDACTED]
- 032 One sealed box labeled "Stevens' Weapon" containing one 9mm caliber [REDACTED]
- 033 One sealed envelope labeled "Ceros Spare Mags (2)" containing two Sig Sauer Magazines each containing 15 live 9mm caliber Speer brand cartridges.

- 034 One sealed envelope labeled "Cerio's Mag (Hot) Removed from weapon" containing one loose live 9mm caliber Speer brand cartridge and one Sig Sauer brand magazine containing twelve live 9mm caliber Speer brand cartridges.

On June 26 the following items of evidence were received from the property room:

- 035 One sealed envelope labeled "2 magazines from unit # 3415 (vehicle) containing two Sig Sauer brand magazines each containing 15 live 9mm caliber Speer brand cartridges.
- 036 One sealed envelope labeled "Stephens' mag. (hot) removed from weapon" containing one loose live 9mm caliber Speer brand cartridge and one Sig Sauer brand magazine containing ten live 9mm caliber Speer brand cartridges.
- 037 One sealed envelope labeled "Stevens' Spare Mags (2)" containing two Sig Sauer brand Magazines each containing fifteen live 9mm caliber Speer brand cartridges.

On July 14, 2003 the following item of evidence was received from Forensic Scientist Edwin Jones.

- 026 One box containing one [REDACTED] and two laboratory envelopes (not examined).

OBJECTIVE: Determine the trajectory of the shots fired. Determine if the pistol, item #026, is operable. Determine what firearm the cartridge cases, item #024, were fired in. Determine what firearm the bullet, item #009, was fired from. Test the ejection pattern of the Sig Sauer pistols, items #031 and #032.

RESULTS: The following is a summary of the analytic findings:

The Taurus exhibits an entry bullet hole (outside to inside of the car) near the back of the driver's window, this is the first entry into the window. The window also exhibits two other holes where fragmented glass has fallen or was driven out. One hole is near the bullet hole and exhibits additional chipping; the second hole is on the lower edge of the glass toward the front of the window and exhibits clear edges. The window on the passenger side exhibits a bullet exit hole (inside to out) at the front edge of a large missing area. The trajectory connecting this to the two rear holes near the rear of the drivers side window exhibits a bullet path that is basically from the left side of the car to the right, slightly back to front and slightly upward. The driver was still seated in the front left seat and was seen to exhibit a hole on the left side of the face near the outer corner of left eye. It would be difficult for the bullet entering the driver's side window bullet entry hole to pass out the exit hole in the passenger window with the driver in a normal driving position. A bullet entering the area left by the hole just ahead of the bullet entry hole could more easily exit the bullet exit in the passenger window without striking the driver.

A Smith & Wesson semiautomatic pistol was resting against the driver with the muzzle forward and the slide downward. As recovered, the hammer was down, the safety was off, both the chamber and magazine were loaded. I unloaded the pistol and placed the magazine and the round from the chamber into an envelope and placed the envelope and firearm in a bag, which was retained by BI personnel. The hammer was lowered using the pistols safety.

The right front tire exhibits a bullet entry on the sidewall near the "L" in "Wrangler" and an exit on the tread surface. The right front rim exhibits a bullet strike that tests positive for lead. The right rear tire exhibits a bullet entry on the side wall near the "D" in "Goodyear" and an exit on the tread surface. The left rear rim exhibits traffic accident like damage and two areas of bullet strike damage that test positive for lead.

Cartridge case positions were observed within the crime scene. All measurements and photographs of the scene and car were taken by other personnel. Additional analysis will be the subject of an additional report.

The Smith & Wesson pistol #026 was examined, test fired and found to be in poor operating condition. The safety was frozen in the off position as received from [REDACTED] however, it was operable on March 21, 2003 when I unloaded the firearm. The firearm fired when tested. The safety is rusted in place. The magazine of item #027 was use in testing the pistol.

The Sig Sauer pistols, #031 and #032 were found to be in normal operating condition. See the attached charts for ejection patterns. The magazines of items #034 and #036, respectively, were use in testing the pistols.

The bullet, item 009, was fired from the Sig Sauer pistol #032.

The cartridge cases, items #024A through #024D were fired in the Sig Sauer pistol #032. The cartridge cases, items #024E through #024G were fired in the Sig Sauer pistol #031.



[REDACTED]
FORENSIC SCIENTIST
7/16/2003

Attachments



COUNTY OF VENTURA SHERIFF'S DEPARTMENT

800 S. VICTORIA AVENUE VENTURA, CA 93009 (805) 654-2370
FORENSIC SCIENCES LABORATORY REPORT

**LAB CASE
NUMBER
L03-1763**

SUBJECT(S): SUSPECT: PEARLMAN, NANCY VICTIM: STEPHENS VICTIM: CERIO	
AGENCY: VENTURA COUNTY SHERIFF'S DEPARTMENT	
Attn: Sgt. Ernie Montagna Major Crimes	
AGENCY CASE NUMBER: 03-08235	OFFENSE(S) INCIDENT, OFFICER INVOLVED

TRACE SECTION

EVIDENCE: On June 11, 2003 the following item was received from property:

026 - (agency item 4) a 9mm Smith & Wesson Model 59 gun.

OBJECTIVE: Collect glass from the gun, item 026.

RESULTS: The following is a summary of the analytic findings:

The gun was examined for fragments with a stereomicroscopic (approximately 7.5 times magnification) appearance of glass. Colorless fragments were collected from fifteen different areas on the gun. These fragments were collected from most of the exposed surfaces of the gun. No fragments were recovered from inside of the barrel.

Fragments were also collected from the magazine, item 027, while in the custody of Jim [REDACTED].

While examining the gun for glass fragments, fine red- [REDACTED] spatter was noted in the area of the "SMITH & WESSON" on the slide. The gun was turned over to forensic scientist Ed [REDACTED] for possible blood spatter interpretation.

COMMENTS:

During examination of the gun, item 026, it was not determined which of the collected fragments were deposited directly onto the gun from the window and which fragments became associated with the gun from contact with glass on the driver's seat and/or from handling.

DISPOSITION OF EVIDENCE:

The colorless fragments collected from the gun, item 026, and magazine, item 027, were placed onto post-it notes in plastic bags and returned to the original items.



F [REDACTED] NSIC SCIENTIST
06/27/2003



COUNTY OF VENTURA SHERIFF'S DEPARTMENT

800 S. VICTORIA AVENUE VENTURA, CA 93009 (805) 654-2370
FORENSIC SCIENCES LABORATORY REPORT

**LAB CASE
NUMBER**
L03-1763

SUBJECT(S): SUSPECT: PEARLMAN, NANCY VICTIM: STEPHENS VICTIM: CERIO	
AGENCY: VENTURA COUNTY SHERIFF'S DEPARTMENT	
Attn: Sgt. Ernie Montagna Major Crimes	
AGENCY CASE NUMBER: 03-08235	OFFENSE(S) INCIDENT, OFFICER INVOLVED

TRACE SECTION

EVIDENCE: On June 11, 2003 the following item was received from property:

026 - (agency item 4) a 9mm Smith & Wesson Model 59 gun.

OBJECTIVE: Collect glass from the gun, item 026.

RESULTS: The following is a summary of the analytic findings:

The gun was examined for fragments with a stereomicroscopic (approximately 7.5 times magnification) appearance of glass. Colorless fragments were collected from fifteen different areas on the gun. These fragments were collected from most of the exposed surfaces of the gun. No fragments were recovered from inside of the barrel.

Fragments were also collected from the magazine, item 027, while in the custody of Jim [REDACTED]

While examining the gun for glass fragments, fine red- [REDACTED] spatter was noted in the area of the "SMITH & WESSON" on the slide. The gun was turned over to forensic scientist Ed [REDACTED] for possible blood spatter interpretation.

COMMENTS:

During examination of the gun, item 026, it was not determined which of the collected fragments were deposited directly onto the gun from the window and which fragments became associated with the gun from contact with glass on the driver's seat and/or from handling.

DISPOSITION OF EVIDENCE:

The colorless fragments collected from the gun, item 026, and magazine, item 027, were placed onto post-it notes in plastic bags and returned to the original items.

[REDACTED]
FORENSIC SCIENTIST
06/27/2003

(TUE) JUL 8 2003 14:19

V. C. S. D. MAJOR CRIMES FX#805+477+7010

DOCUMENT #	TIME STORED	TIME SENT	DURATION	PAGE (S)	MODE	RESULT
4862060-675	7. 8 14:17	7. 8 14:17	1' 03"	3	ECM	OK

DESTINATION	DST. TEL #
96543850	96543850



VENTURA COUNTY SHERIFF'S DEPARTMENT

- BOB BROOKS
SHERIFF
- CRAIG HUSBAND
UNDERSHERIFF

800 SOUTH VICTORIA AVENUE, VENTURA, CA 93009 PHONE (805) 654-2380

SPECIAL SERVICES

FAX TRANSMITTAL SHEET

Date: 7, 8, 03

To: Bill Haney FAX Number: 6543850

Agency/Company: D.A. office

From: E. MONTAGNA FAX Number: (805) 477-7910

Number of pages (including this sheet): 3

Regarding:

Pearlman Case
Roberts stated he is completing
his report & will send you a
copy



VENTURA COUNTY SHERIFF'S DEPARTMENT

- BOB BROOKS
SHERIFF
- CRAIG HUSBAND
UNDERSHERIFF

800 SOUTH VICTORIA AVENUE, VENTURA, CA 93009 PHONE (805) 654-2380

SPECIAL SERVICES

FAX TRANSMITTAL SHEET

Date: 7, 8, 03

To: Bill Haney FAX Number: 6543850

Agency/Company: D.A. office

From: E. MONTAGNA FAX Number: (805) 477-7910

Number of pages (including this sheet): 3

Regarding:

Pearlman Case
- Roberts stated he is completing
his report & will send you a
copy

NOTE: If any of these faxed copies are illegible, or you do not receive the same number of pages as stated above, please contact us immediately at: ()

4777037

VENTURA COUNTY REGIONAL CRIME LABORATORY
 Sheriff's Department
 800 South Victoria Avenue, Ventura, California 93009
 Telephone Number: (805) 654-2377

REQUEST FOR ANALYSIS/EXAMINATION OF EXHIBITS

1. VICTIM/PERSON REPORTING OFFENSE: STEPHENS, J.	2. ACCUSED/SUSPECT: PEARLMAN	3. OFFENSE INVESTIGATED: (a) OFFENSE <u>417 PC</u> (b) <input checked="" type="checkbox"/> FELONY <input type="checkbox"/> MISDEMEANOR
4. INVESTIGATING AGENCY: VCSO	5. AGENCY SECTION - BRANCH - UNIT: MAJOR CRIMES	6. DATE OF OFFENSE: 3-20-03
7. INVESTIGATING OFFICER(S): TELEPHONE NO.: 4777037	8. EXHIBITS DELIVERED BY:	9. <input checked="" type="checkbox"/> NEW CASE <input type="checkbox"/> ADDITIONAL EXHIBITS
10. LABORATORY REPORT TO BE SENT TO: SGT. ERNIE MONTAGNA	11. MAILING ADDRESS: MAJOR CRIMES BROWN MAIL # 4016	12. AGENCY FILE NUMBER: 03-8235
13. IS SUBJECT IN CUSTODY? <input type="checkbox"/> YES <input checked="" type="checkbox"/> NO	14. DATE AND TYPE OF TRIAL OR HEARING:	15. (a) AGENCY RECORD SECTION NUMBER: (b) AGENCY PROPERTY ROOM NUMBER:
16. DETAILS OF INVESTIGATION PERTINENT TO EXHIBITS (RELEVANT PORTION OF CRIME REPORT MAY BE ATTACHED): OFFICER INVOLVED SHOOTING -		
17. EXHIBITS (LIST ITEMS AND SOURCES. USE SEPARATE PLAIN SHEET IF MORE SPACE IS REQUIRED): 1. SUSP'S HANDEGUN - S&W. 9mm SEMI-AUTO		
18. SPECIFIC EXAMINATION REQUESTED: CHECK HANDEGUN FOR TRACE EVIDENCE - ANY GLASS FRAGMENTS.		
19. SIGNATURE OF REQUESTING OFFICER: <i>E. Montagna</i> 1047	20. DATE: 3-4-1-03	
NOTE: IF THERE IS A CHANGE IN THE STATUS OF THIS CASE (CASE CLOSED, TRIAL DATE CHANGED, ETC.), PLEASE CONTACT THE LABORATORY IMMEDIATELY.	FOR LABORATORY USE ONLY LABORATORY LOG NUMBER: CASE ASSIGNED TO: DATE:	

VENTURA COUNTY REGIONAL CRIME LABORATORY
 Sheriff's Department
 800 South Victoria Avenue, Ventura, California 93009
 Telephone Number: (805) 654-2377

REQUEST FOR ANALYSIS/EXAMINATION OF EXHIBITS

2 of 2

1. VICTIM/PERSON REPORTING OFFENSE: <p style="font-size: 1.2em; text-align: center;">STEPHENS</p>	2. ACCUSED/SUSPECT: <p style="font-size: 1.2em; text-align: center;">PEARLMAN</p>	3. OFFENSE INVESTIGATED: (a) OFFENSE <u>417 P.C.</u> (b) <input checked="" type="checkbox"/> FELONY <input type="checkbox"/> MISDEMEANOR
4. INVESTIGATING AGENCY: <p style="font-size: 1.2em; text-align: center;">VCSO</p>	5. AGENCY SECTION - BRANCH - UNIT: <p style="font-size: 1.2em; text-align: center;">MATDR CRIMES</p>	6. DATE OF OFFENSE: <p style="font-size: 1.2em; text-align: center;">3-20-2003</p>
7. INVESTIGATING OFFICER(S): TELEPHONE NO.: <u>4777037</u>	8. EXHIBITS DELIVERED BY:	9. <input checked="" type="checkbox"/> NEW CASE <input type="checkbox"/> ADDITIONAL EXHIBITS
10. LABORATORY REPORT TO BE SENT TO: <p style="font-size: 1.2em; text-align: center;">Sgt. MONTAGNA</p>	11. MAILING ADDRESS <u>BRO MAIL 4016</u> <p style="font-size: 1.2em; text-align: center;">MATDR CRIMES</p>	12. AGENCY FILE NUMBER: <p style="font-size: 1.2em; text-align: center;">03-8235</p>
13. IS SUBJECT IN CUSTODY? <input type="checkbox"/> YES <input checked="" type="checkbox"/> NO	14. DATE AND TYPE OF TRIAL OR HEARING:	15. (a) AGENCY RECORD SECTION NUMBER: (b) AGENCY PROPERTY ROOM NUMBER:
16. DETAILS OF INVESTIGATION PERTINENT TO EXHIBITS (RELEVANT PORTION OF CRIME REPORT MAY BE ATTACHED): <p style="font-size: 1.2em; text-align: center;">OFFICER INVOLVED SHOOTING</p>		
17. EXHIBITS (LIST ITEMS AND SOURCES. USE SEPARATE PLAIN SHEET IF MORE SPACE IS REQUIRED): <ol style="list-style-type: none"> 1. RIMS ON SUSP'S VEHICLE W/ BULLET STRIKES - LIR & RIR (RIMS TO BE BOOKED AS EVIDENCE) 2. SUSP'S VEH - XXXXXXXXXX (CRIME LAB GARAGE) 		
18. SPECIFIC EXAMINATION REQUESTED: <ol style="list-style-type: none"> 1. CHECK BULLET STRIKES ON RIMS FOR MENTAL TRANSFERS 2. PHOTOS OF SUSP'S VEHICLE SIDE-WINDOWS W/ BULLET HOLES — USE RODS TO DEMONSTRATE BULLET PATHS. 3. CHECK FOR DEPS' EJECTING (CARTRIDGE) CASE PATTERNS. 4. PHOTOS OF ALL HANDGUNS W/ MAGAZINES & AMMUNITION. 		
19. SIGNATURE OF REQUESTING OFFICER: <p style="font-size: 1.2em; text-align: center;">S. Montagna 1047</p>	20. DATE: <p style="font-size: 1.2em; text-align: center;">3-25-2003</p>	
NOTE: IF THERE IS A CHANGE IN THE STATUS OF THIS CASE (CASE CLOSED, TRIAL DATE CHANGED, ETC.), PLEASE CONTACT THE LABORATORY IMMEDIATELY.	FOR LABORATORY USE ONLY LABORATORY LOG NUMBER: CASE ASSIGNED TO: DATE:	

VENTURA COUNTY REGIONAL CRIME LABORATORY
 Sheriff's Department
 800 South Victoria Avenue, Ventura, California 93009
 Telephone Number: (805) 654-2377

REQUEST FOR ANALYSIS/EXAMINATION OF EXHIBITS

10f2

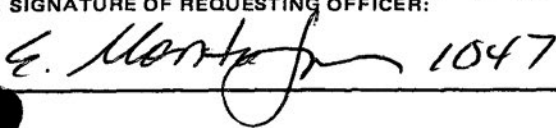
1. VICTIM/PERSON REPORTING OFFENSE: STEPHENS, J.	2. ACCUSED/SUSPECT: PEARLMAN, NANCY	3. OFFENSE INVESTIGATED: (a) OFFENSE <u>417(c) P.C.</u> (b) <input checked="" type="checkbox"/> FELONY <input type="checkbox"/> MISDEMEANOR
4. INVESTIGATING AGENCY: VCSO	5. AGENCY SECTION - BRANCH - UNIT: MAJOR CRIMES	6. DATE OF OFFENSE: 3-20-2003
7. INVESTIGATING OFFICER(S): TELEPHONE NO.: 4777037	8. EXHIBITS DELIVERED BY:	9. <input checked="" type="checkbox"/> NEW CASE <input type="checkbox"/> ADDITIONAL EXHIBITS
10. LABORATORY REPORT TO BE SENT TO: SGT. E. MONTANA	11. MAILING ADDRESS: MAJOR CRIMES	12. AGENCY FILE NUMBER: 03-8235
13. IS SUBJECT IN CUSTODY? <input type="checkbox"/> YES <input checked="" type="checkbox"/> NO	14. DATE AND TYPE OF TRIAL OR HEARING:	15. (a) AGENCY RECORD SECTION NUMBER: (b) AGENCY PROPERTY ROOM NUMBER:
16. DETAILS OF INVESTIGATION PERTINENT TO EXHIBITS (RELEVANT PORTION OF CRIME REPORT MAY BE ATTACHED): OFFICER INVOLVED SHOOTING SUSPECT POINTS HANDGUN AT DEPUTY. DEPUTY SHOTS SUSPECT. SUSPECT DIED FROM SINGLE GUNSHOT WOUND.		
EXHIBITS (LIST ITEMS AND SOURCES. USE SEPARATE PLAIN SHEET IF MORE SPACE IS REQUIRED): 1. SR. DEPUTY STEPHENS' DEPT. ISSUED 9mm HANDGUN w/ ROUNDS + MAGAZINES. 2. DEP. CERIO DEPT. ISSUED 9mm HANDGUN w/ ROUNDS + MAGAZINE. 3. BULLET REMOVED FROM SUSP @ THE AUTOPSY. 4. SUSP'S 9mm HANDGUN w/ ROUNDS + MAGAZINE. 5. 9mm SHELL CASINGS RECOVERED @ SCENE.		
18. SPECIFIC EXAMINATION REQUESTED: 1. COMPARE SHELL CASINGS TO DEPUTIES' HANDGUN. 2. COMPARE BULLET REMOVED FROM VICTIM TO DEPUTIES' HANDGUN 3. CHECK THE OPERATION OF SUSP. HANDGUN & DEPS' HANDGUN. 4. REPORT CONCERNING ON SCENE INVESTIGATION		
19. SIGNATURE OF REQUESTING OFFICER:  1047	20. DATE: 3-25-2003	
FOR LABORATORY USE ONLY		
NOTE: IF THERE IS A CHANGE IN THE STATUS OF THIS CASE (CASE CLOSED, TRIAL DATE CHANGED, ETC.), PLEASE CONTACT THE LABORATORY IMMEDIATELY.		
LABORATORY LOG NUMBER: CASE ASSIGNED TO:		DATE:

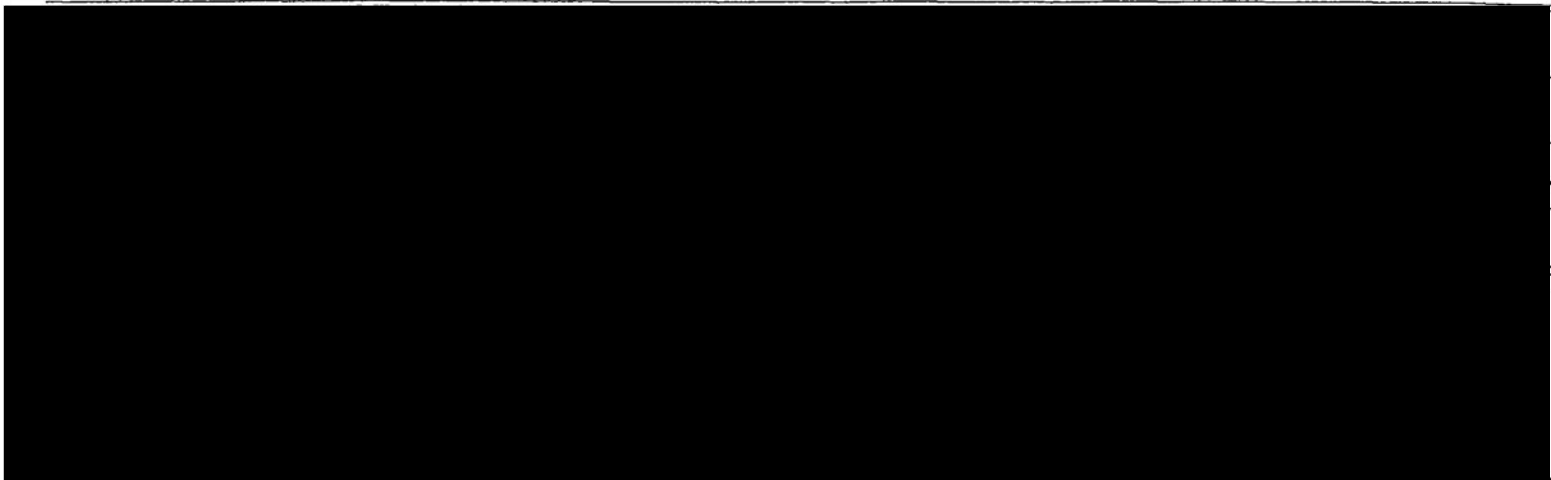

STORED **IMPOUNDED** **RELEASED** **RECOVERED - VEHICLE / COMPONENT**

TOWING / STORAGE CONCERN (NAME, ADDRESS, PHONE) STORAGE AUTHORITY / REASON

OWL TOWING 2981 VENTURA BLVD OXNARD 985-3811 VC 22655.5 (B)

TOWED TO / STORED AT AIRBAG? DRIVEABLE? VIN SWITCHED?

CRIME LAB YES NO 1 2 YES NO JUNK UNK YES NO

CONDITION	YES	NO	ITEMS	YES	NO	ITEMS	YES	NO	ITEMS	YES	NO	TIRES / WHEELS	CONDITION
WRECKED			SEAT (FRONT)	<input checked="" type="checkbox"/>		REGISTRATION			CAMPER			LEFT FRONT	FLAT
BURNED HULK per 431(c) VC		<input checked="" type="checkbox"/>	SEAT (REAR)	<input checked="" type="checkbox"/>		ALT. / GENERATOR	<input checked="" type="checkbox"/>		VESSEL AS LOAD			RIGHT FRONT	FLAT
VANDALIZED		<input checked="" type="checkbox"/>	RADIO	<input checked="" type="checkbox"/>		BATTERY	<input checked="" type="checkbox"/>		FIREARMS			LEFT REAR	FLAT
ENG. / TRANS. STRIP		<input checked="" type="checkbox"/>	TAPE DECK	<input checked="" type="checkbox"/>		DIFFERENTIAL	<input checked="" type="checkbox"/>		OTHER			RIGHT REAR	FLAT
MISC. PARTS STRIP		<input checked="" type="checkbox"/>	TAPES		<input checked="" type="checkbox"/>	TRANSMISSION	<input checked="" type="checkbox"/>					SPARE	
Y METAL STRIP		<input checked="" type="checkbox"/>	OTHER RADIO		<input checked="" type="checkbox"/>	AUTOMATIC	<input checked="" type="checkbox"/>					HUB CAPS	
ICAL STRIP per 431(b) VC		<input checked="" type="checkbox"/>	IGNITION KEY	<input checked="" type="checkbox"/>		MANUAL		<input checked="" type="checkbox"/>				SPECIAL WHEELS	

RELEASE VEHICLE TO: R/O OR AGENT AGENCY HOLD 22850.3 VC GARAGE PRINCIPAL / AGENT STORING VEHICLE (SIGNATURE) DATE / TIME

NAME OF PERSON / AGENCY AUTHORIZING RELEASE I.D. NO. DATE CERTIFICATION: I, THE UNDERSIGNED, DO HEREBY CERTIFY THAT I AM LEGALLY AUTHORIZED AND ENTITLED TO TAKE POSSESSION OF THE ABOVE DESCRIBED VEHICLE.

SIGNATURE OF PERSON AUTHORIZING RELEASE SIGNATURE OF PERSON TAKING POSSESSION

STOLEN VEHICLE / COMPONENT **EMBEZZLED VEHICLE** **PLATE(S) REPORT**

DATE / TIME OF OCCURRENCE DATE / TIME REPORTED NAME OF REPORTING PARTY (R/P) DRIVER LICENSE NO. / STATE

LAST DRIVER OF VEHICLE DATE / TIME ADDRESS OF R/P TELEPHONE OF R/P ()

I CERTIFY OR DECLARE UNDER PENALTY OF PERJURY UNDER THE LAWS OF THE STATE OF CALIFORNIA THAT THE FOREGOING IS TRUE AND CORRECT. SIGNATURE OF PERSON MAKING REPORT

REMARKS
[LIST PROPERTY, TOOLS, VEHICLE DAMAGE, ARRESTS]

DRIVER'S NAME ARRESTED / SECTION? REPORTED BY CARGO / TYPE? VALUE \$

YES NO YES NO BILL OF LADING ATTACHED

INVENTORY - BLANKET / PORTABLE PUMP / PHONE CHARGER
HAIR BRUSH

IMPOUND PER SGT. AYUB
FAXED @ 0530 HOURS

ARK #426 TELETYPE CALLED @ 0535 HOURS

FRONT LEFT SIDE RIGHT SIDE REAR TOP

SIGNATURE OF OFFICER TAKING REPORT I.D. NO. SUPERVISOR REQUIRED NOTICES SENT TO REGISTERED AND LEGAL OWNERS PER 22852 VC7 YES NO DATE NOTIFIED

MULROONEY 3283 [Signature] YES NO []

VENTURA COUNTY SHERIFF'S DEPARTMENT VEHICLE DAMAGE / TOW REPORT

TOW REPORT ONLY

COPY

ORG. NUMBER
03-8235

LOCATION	OCCURRENCE MUGU STATE REACH		CITY PT. MUGU		MO. 3	DAY 20	YEAR 03	TIME (2400) 1915	DAY OF WEEK S M T W T F S			
	MILEPOST INFORMATION											
SHERIFF'S UNIT	<input type="checkbox"/> AT INTERSECTION WITH <input checked="" type="checkbox"/> OR: 2 FEET/MILES E OF LAS POSAS											
	[REDACTED SECTION]											
PART 2	[REDACTED SECTION]											
PART 3	[REDACTED SECTION]											
DRIVER	NAME (First, Middle, Last)				OWNER'S NAME							
<input type="checkbox"/>	STREET ADDRESS				OWNER'S ADDRESS							
<input type="checkbox"/>	CITY/STATE/ZIP				DISPOSITION OF VEHICLE							
<input type="checkbox"/>	SEX	HAIR	EYES	HEIGHT	WEIGHT	MO.	BIRTHDATE DAY	YEAR	RACE	NAME OF TOW COMPANY		
<input type="checkbox"/>	HOME PHONE () ()				BUSINESS PHONE () ()				DESCRIBE VEHICLE DAMAGE SHADE IN DAMAGED AREA			
<input type="checkbox"/>	INSURANCE CARRIER				<input type="checkbox"/> UNK. <input type="checkbox"/> NONE <input type="checkbox"/> MINOR <input type="checkbox"/> MOD. <input type="checkbox"/> MAJOR <input type="checkbox"/> TOTAL							
<input type="checkbox"/>	DIR. OF TRAVEL	ON STREET OR HIGHWAY				SPEED LIMIT						
DRIVER (Print Name) JASON STEPHENS			LD. NUMBER 2743		DRIVER'S SIGNATURE			CONTACT PHONE NUMBER		DATE 5-23-03		
COMMANDER SIGNATURE					BUREAU			DATE REVIEWED				

PROPERTY DAMAGE	OWNER'S NAME/ADDRESS	NOTIFIED <input type="checkbox"/> YES <input type="checkbox"/> NO
	DESCRIPTION OF DAMAGE	

INJURED/WITNESSES/PASSENGERS

V. ONLY	PASSENGER ONLY	AGE	SEX	EXTENT OF INJURY ("X" ONE)				INJURED WAS ("X" ONE)				PARTY NUMBER	SEAT POS.	SAFETY EQUIP.	EJECT
				FATAL INJURY	SEVERE INJURY	OTHER VISIBLE INJURY	COMPLAINT OF PAIN	DRIVER	PASS.	PED.	BYCYCLIST				
<input type="checkbox"/>	<input type="checkbox"/>			<input checked="" type="checkbox"/>	<input type="checkbox"/>	<input type="checkbox"/>	<input type="checkbox"/>	<input checked="" type="checkbox"/>	<input type="checkbox"/>	<input type="checkbox"/>	<input type="checkbox"/>				

NAME/D.O.B./ADDRESS	TELEPHONE (Home)
TRANSPORTED BY (Injured Only)	TAKEN TO
TELEPHONE (Business)	

DESCRIBE INJURIES

<input type="checkbox"/>	<input type="checkbox"/>			<input type="checkbox"/>	<input type="checkbox"/>	<input type="checkbox"/>	<input type="checkbox"/>	<input type="checkbox"/>	<input type="checkbox"/>	<input type="checkbox"/>	<input type="checkbox"/>			
--------------------------	--------------------------	--	--	--------------------------	--------------------------	--------------------------	--------------------------	--------------------------	--------------------------	--------------------------	--------------------------	--	--	--

NAME/D.O.B./ADDRESS	TELEPHONE (Home)
TRANSPORTED BY (Injured Only)	TAKEN TO
TELEPHONE (Business)	

DESCRIBE INJURIES

NARRATIVE

2. DEPUTY STEPHENS USED LEGAL INTERVENTION ON V2 CAUSING DAMAGE
 STEPHEN'S UNIT AND V2. REFER TO MAJOR CRIMES' INVESTIGATION
 FOR FURTHER.

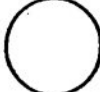
<p>SKETCH</p> <div style="text-align: center; margin-top: 50px;">  <p>INDICATE NORTH</p> </div>	<p style="text-align: center;">SAFETY EQUIPMENT CODES</p> <div style="display: flex; justify-content: space-between;"> <div style="width: 60%;"> <p>OCCUPANTS</p> <ul style="list-style-type: none"> A - NONE IN VEHICLE B - UNKNOWN C - LAP BELT USED D - LAP BELT NOT USED E - SHOULDER HARNESS USED F - SHOULDER HARNESS NOT USED G - LAP/SHOULDER HARNESS USED H - LAP/SHOULDER HARNESS NOT USED J - PASSIVE RESTRAINT USED K - PASSIVE RESTRAINT NOT USED L - AIR BAG DEPLOYED M - AIR BAG NOT DEPLOYED N - OTHER P - NOT REQUIRED <p>CHILD RESTRAINT</p> <ul style="list-style-type: none"> Q - IN VEHICLE USED R - IN VEHICLE NOT USED S - IN VEHICLE USE UNKNOWN T - IN VEHICLE IMPROPER USE U - NONE IN VEHICLE </div> <div style="width: 35%;"> <p>WC BICYCLE - HELMET</p> <ul style="list-style-type: none"> DRIVER V-NO W-YES <p>PASSENGER</p> <ul style="list-style-type: none"> X-NO Y-YES </div> </div>
------------------------------------------------------------------------------------------------------------------------------------------------------------------------------------	-----------------------------------------------------------------------------------------------------------------------------------------------------------------------------------------------------------------------------------------------------------------------------------------------------------------------------------------------------------------------------------------------------------------------------------------------------------------------------------------------------------------------------------------------------------------------------------------------------------------------------------------------------------------------------------------------------------------------------------------------------------------------------------------------------------------------------------------------------------------------------------------------------------------------------------------------------------------------------------------------------------------------------------------------------------------------------------------------------------------------------------------------------------------------------------------------------------

VENTURA COUNTY SHERIFF'S DEPARTMENT VEHICLE DAMAGE / TOW REPORT

TOW REPORT ONLY

ORG. NUMBER
03-8235

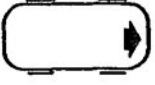
LOCATION	OCCURRED ON MUGU STATE BEACH		CITY PT. MUGU		MO. 3	DAY 20	YEAR 03	TIME (2400) 1915	DAY OF WEEK S M T W T F S		
	MILEPOST INFORMATION										
SHERIFF'S UNIT	<input type="checkbox"/> AT INTERSECTION WITH <input checked="" type="checkbox"/> OR: 2 FEET/MILES E OF LAS POSAS										
	POLICE REPORT <input checked="" type="checkbox"/> N			AGENCY VENTURA SHERIFF			REPORT# 03-8235				
DRIVER LICENSE NUMBER _____ STATE _____ CLASS _____ SAFETY EQUIP. _____ VEH. YR. _____ MAKE/MODEL/COLOR _____ LICENSE NUMBER/STATE _____											
[REDACTED]											
PARTY 2 DRIVER <input type="checkbox"/> PEDESTRIAN <input type="checkbox"/> PARKED VEHICLE <input type="checkbox"/> BICYCLIST <input type="checkbox"/> OTHER <input type="checkbox"/>											
INSURANCE CARRIER _____					<input type="checkbox"/> UNK. <input type="checkbox"/> NONE <input type="checkbox"/> MINOR <input checked="" type="checkbox"/> MOD. <input type="checkbox"/> MAJOR <input type="checkbox"/> TOTAL						
DIR. OF TRAVEL UNK		ON STREET OR HIGHWAY IN PARKING LOT			SPEED LIMIT _____						
PARTY 3 DRIVER LICENSE NUMBER _____ STATE _____ CLASS _____ SAFETY EQUIP. _____ VEH. YR. _____ MAKE/MODEL/COLOR _____ LICENSE NUMBER/STATE _____											
DRIVER NAME (First, Middle, Last) _____											
STREET ADDRESS _____					OWNER'S NAME _____ <input type="checkbox"/> SAME AS DRIVER						
CITY/STATE/ZIP _____					OWNER'S ADDRESS _____ <input type="checkbox"/> SAME AS DRIVER						
SEX		HAIR	EYES	HEIGHT	WEIGHT	MO.	BIRTHDATE DAY	YEAR	RACE	DISPOSITION OF VEHICLE <input type="checkbox"/> TOWED <input type="checkbox"/> DRIVABLE	NAME OF TOW COMPANY _____
OTHER HOME PHONE () _____ BUSINESS PHONE () _____					DESCRIBE VEHICLE DAMAGE SHADE IN DAMAGED AREA						
INSURANCE CARRIER _____					<input type="checkbox"/> UNK. <input type="checkbox"/> NONE <input type="checkbox"/> MINOR <input type="checkbox"/> MOD. <input type="checkbox"/> MAJOR <input type="checkbox"/> TOTAL						
DIR. OF TRAVEL		ON STREET OR HIGHWAY			SPEED LIMIT						
Driver (Print Name) STEVE CERIO			I.D. NUMBER 3415		DRIVER'S SIGNATURE _____			CONTACT PHONE NUMBER _____		DATE 3-23-03	
COMMANDER SIGNATURE _____					BUREAU _____			DATE REVIEWED _____			

PROPERTY DAMAGE	OWNER'S NAME/ADDRESS	NOTIFIED <input type="checkbox"/> YES <input type="checkbox"/> NO
	DESCRIPTION OF DAMAGE	

INJURED/WITNESSES/PASSENGERS

WITNESS ONLY	PASSENGER ONLY	AGE	SEX	EXTENT OF INJURY ("X" ONE)				INJURED WAS ("X" ONE)					PARTY NUMBER	SEAT POS.	SAFETY EQUIP.	EJECT
				FATAL INJURY	SEVERE INJURY	OTHER VISIBLE INJURY	COMPLAINT OF PAIN	DRIVER	PASS.	PED.	BYCYCLIST	OTHER				
<input type="checkbox"/>	<input type="checkbox"/>			<input type="checkbox"/>	<input type="checkbox"/>	<input type="checkbox"/>	<input type="checkbox"/>	<input type="checkbox"/>	<input type="checkbox"/>	<input type="checkbox"/>	<input type="checkbox"/>	<input type="checkbox"/>				

NAME/D.O.B./ADDRESS	TELEPHONE (Home)
TRANSPORTED BY (Injured Only) TAKEN TO	TELEPHONE (Business)

DESCRIBE INJURIES

<input type="checkbox"/>	<input type="checkbox"/>			<input type="checkbox"/>	<input type="checkbox"/>	<input type="checkbox"/>	<input type="checkbox"/>	<input type="checkbox"/>	<input type="checkbox"/>	<input type="checkbox"/>	<input type="checkbox"/>	<input type="checkbox"/>				
--------------------------	--------------------------	--	--	--------------------------	--------------------------	--------------------------	--------------------------	--------------------------	--------------------------	--------------------------	--------------------------	--------------------------	--	--	--	--

NAME/D.O.B./ADDRESS	TELEPHONE (Home)
TRANSPORTED BY (Injured Only) TAKEN TO	TELEPHONE (Business)

DESCRIBE INJURIES

NARRATIVE

DEPUTY CERRO'S UNIT WAS DAMAGED DURING A CONTACT WITH SUICIDAL SUBJECT. REFER TO MAJOR CRIMES' INVESTIGATION - DETAILS.

SKETCH



INDICATE NORTH

- SAFETY EQUIPMENT CODES**
- | | |
|------------------------------------------------------------------------------------------------------------------------------------------------------------------------------------------------------------------------------------------------------------------------------------------------------------------------------------------------------------------------------------------------------------------------------------------------------------------------------------------------------------------------------------------------------------------------------------------------------------------------------------------------------------------------------------------------------------------------------------------------------------------------------|-------------------------------------------------------------------------------------------------------------------------------------------------------------------------------------------------------------------------------|
| <p>OCCUPANTS</p> <ul style="list-style-type: none"> A - NONE IN VEHICLE B - UNKNOWN C - LAP BELT USED D - LAP BELT NOT USED E - SHOULDER HARNESS USED F - SHOULDER HARNESS NOT USED G - LAP/SHOULDER HARNESS USED H - LAP/SHOULDER HARNESS NOT USED J - PASSIVE RESTRAINT USED K - PASSIVE RESTRAINT NOT USED L - AIR BAG DEPLOYED M - AIR BAG NOT DEPLOYED N - OTHER P - NOT REQUIRED <p>CHILD RESTRAINT</p> <ul style="list-style-type: none"> Q - IN VEHICLE USED R - IN VEHICLE NOT USED S - IN VEHICLE USE UNKNOWN T - IN VEHICLE IMPROPER USE U - NONE IN VEHICLE | <p>WC BICYCLE - HELMET</p> <ul style="list-style-type: none"> DRIVER V - NO W - YES <p>PASSENGER</p> <ul style="list-style-type: none"> X - NO Y - YES |
|------------------------------------------------------------------------------------------------------------------------------------------------------------------------------------------------------------------------------------------------------------------------------------------------------------------------------------------------------------------------------------------------------------------------------------------------------------------------------------------------------------------------------------------------------------------------------------------------------------------------------------------------------------------------------------------------------------------------------------------------------------------------------|-------------------------------------------------------------------------------------------------------------------------------------------------------------------------------------------------------------------------------|

NARRATIVE REPORT VENTURA COUNTY SHERIFF'S DEPARTMENT

Page 1 of 1 Continuation

AGENCY IDENTIFIER CA0560000

1 P.D. **3261**

2 BEAT **3C**

3 RB NUMBER **03-0235**

4 CODE	5 ITEM	6 QTY.	7 ITEM NAME	8 BRAND / MAKE MANUFACTURER	9 MODEL NAME OR NUMBER	10 MISC. DESCRIPTION	11 IDENTIFICATION / SERIAL NUMBER	12 VALUE
--------	--------	--------	-------------	-----------------------------	------------------------	----------------------	-----------------------------------	----------

Supplemental **Case Cleared**

Gang **Domestic** **Hate** **Child Abuse** **Elderly Abuse**

Connecting Report Numbers:

Code Section / Description: OFFICER INVOLVED SHOOTING

Code: SUSPECT Name: PEARLMAN, NANCY

On 4-7-2003, I assisted in removing the suspect's vehicle from the Crime Lab and had it towed to the Todd Road Jail Facility storage yard pending further investigation. The vehicle's doors and hood were resealed with evidence tape. The vehicle's key was returned to property.

13 DATE/TIME OF REPORT **04/25/03 7:10:53**

14 REPORTING OFFICER ID NO / UNIT **E. Montagna #10477 Sgt.**

15 APPROVED BY / ID NO

NARRATIVE REPORT VENTURA COUNTY SHERIFF'S DEPARTMENT

Page 1 of 2 Continuation

AGENCY IDENTIFIER CA0560000

1 R.D.	2 BEAT	3 RB NUMBER
3262	3602	2003-8235

4 CODE	5 ITEM	6 QTY.	7 ITEM NAME	8 BRAND / MAKE MANUFACTURER	9 MODEL NAME OR NUMBER	10 MISC. DESCRIPTION	11 IDENTIFICATION / SERIAL NUMBER	12 VALUE
--------	--------	--------	-------------	-----------------------------	------------------------	----------------------	-----------------------------------	----------

Incident Log Check -in

Time in	CALL SIGN	NAME	Time out
1915 hours	3C51	Stephens #2743	0430 hours
1920 hours	3D51	Cerio #3415	0230 hours
1923 hours	5G11	Heersche #1312	2236 hours
1923 hours	5G11	McConville #3419	2236 hours
1924 hours	5G21	Marco #3126	2211 hours
1924 hours	5G21	Schierman #2347	2211 hours
1927 hours	3C22	Mulrooney #3283	0445 hours
1931 hours	3C21	Fast #3220	0445 hours
1934 hours	5G23	Clancy #2605	2044 hours
1934 hours	5G23	Young #3544	2044 hours
1934 hours	CAR12	Cmdr. Tennessen #1186	2135 hours
1936 hours	3D52	Schwieder #3018	0147 hours
1937 hours	3D22	Tuazon #3358	0445 hours
1939 hours	5I	Miller #1968	2135 hours
1942 hours	3S19	Hanley #2063	0445 hours
Est. 1945 hours	5G13	Gleason #3046	2044 hours
Est. 1945 hours	5G13	Corbin #2875	2044 hours
Est. 1945 hours	5G24	Payton #3011	2050 hours
Est. 1945 hours	5G24	Hajducko #3047	2050 hours
1950 hours	5G10	Lareva #1998	2155 hours
1958 hours	5H2	Smith #2622	2248 hours
2003 hours	5H16	Ayub #3318	0210 hours
2007 hours	5H13	Rubright #1935	0133 hours
2014 hours	5H17	Rivera #2696	0445 hours
2015 hours	5H7	Montagna #1047	0445 hours
2019 hours	5H1	Powers #1365	2130 hours
Est. 2020 hours	5H9	Place #1393	0210 hours
Est. 2020 hours	5L	Fadler #0684	0135 hours
2027 hours	11I4	Dowd #2550	0430 hours
2030 hours	Cnty Attny	Alan Witsosky	0130 hours
2030 hours	VCDSA	Rick Shimmel	0434 hours

13 DATE / TIME OF REPORT

3/23/03

0530

14 REPORTING OFFICER / ID NO / DIV / UNIT

MULROONEY / 3283 / WCPS / CAM

15 APPROVED BY / ID NO

S. Aguly / 12486

NARRATIVE REPORT VENTURA COUNTY SHERIFF'S DEPARTMENT

Page 2 of 2 Continuation

AGENCY IDENTIFIER CA0560000

1 R.D. 3262	2 BEAT 302	3 RB NUMBER 2003-8235
----------------	---------------	--------------------------

4 CODE	5 ITEM	6 QTY.	7 ITEM NAME	8 BRAND / MAKE MANUFACTURER	9 MODEL NAME OR NUMBER	10 MISC. DESCRIPTION	11 IDENTIFICATION / SERIAL NUMBER	12 VALUE
--------	--------	--------	-------------	-----------------------------	------------------------	----------------------	-----------------------------------	----------

Incident Log Check -in

Time in	CALL SIGN	NAME	Time out
2045 hours	BI	[REDACTED] #3322	0443 hours
2045 hours	BI	[REDACTED] #4008	0443 hours
2045 hours	BI	[REDACTED] #3832	0443 hours
2050 hours	Chaplain	[REDACTED] #734V	2328 hours
2054 hours	8XS	Hoelker #1901	0445 hours
2055 hours		Cmdr. Purnell #0870	2356 hours
2117 hours	Med Exim	Mike Fieller #44	0325 hours

2126 hours	PIO	Noshimoto #3731	2341 hours
2130 hours		Chief Dep. Honorico #0949	2322 hours
2130 hours	LDF Attny	Ken Yuwiler	0435 hours
2131 hours	11I	Matson #1875	0120 hours
2145 hours	5ES	Obregon #1282	Est. 0430 hours
2200 hours	11I1	Macedo #1440	2324 hours
2200 hours	11I2	Kenney #1794	Est. 0430 hours
2212 hours	DA Invest.	Dave Stone #7	Est. 0430 hours
2220 hours	Dep. D.A.	John West #238	Est. 0430 hours
2240 hours	8L	DeCesari # 0979	0139 hours
0003 hours	8T	Popp #2277	0230 hours
0034 hours	Crime Lab	[REDACTED] #3263	0315 hours
0100 hours	CMA	Frank [REDACTED]	0315 hours
0100 hours	CMA	John [REDACTED]	0315 hours
0138 hours	3C22	Hinahon #2913	0445 hours
0405 hours	Owl Tow	Joe [REDACTED]	0430 hours
0434 hours	3D23	Hardy #3096	0442 hours
0434 hours	3D23	Sparks #2409	0442 hours

13 DATE / TIME OF REPORT 3/23/03 0530	14 REPORTING OFFICER / ID NO / DIV / UNIT MULROONEY/3283/WCPD/CAM	15 APPROVED BY / ID NO [Signature] / 7486
------------------------------------------	----------------------------------------------------------------------	----------------------------------------------

NARRATIVE REPORT VENTURA COUNTY SHERIFF'S DEPARTMENT

Page 1 of 6 Continuation

AGENCY IDENTIFIER CA0560000

1 R.D.	2 BEAT	3 RB NUMBER
3262	3C2	2003-8235

4 CODE	5 ITEM	6 QTY.	7 ITEM NAME	8 BRAND / MAKE MANUFACTURER	9 MODEL NAME OR NUMBER	10 MISC. DESCRIPTION	11 IDENTIFICATION / SERIAL NUMBER	12 VALUE
--------	--------	--------	-------------	-----------------------------	------------------------	----------------------	-----------------------------------	----------

NARRATIVE: SUPPLEMENTAL: CASE CLOSED:

CONNECTING REPORT NUMBERS:

CODE SECTION / DESCRIPTION: PC 417(c) / Brandishing

RECLASSIFY TO:

CODE: S NAME: Pearlman, Nancy

On 3-20-03, at about 1915 hours, I responded Code 3 to assist units with a suicidal subject at Pt. Mugu State Beach. I arrived at the scene at about 1930 hours. I was directed by Sr. Deputy Schierman to park my unit eastbound on the south side of the PCH, just east of the entrance to the beach area.

Sr. Deputy Schierman directed me to start a crime scene log. I started the log of the inner crime scene at about 1930 hours. All personnel who entered the inner crime scene did so through the gate to the parking lot of the beach area. I kept the log from 1930 hours until the scene was cleared at about 0450 hours. Sgt. Hanley directed me to complete the county vehicle damage reports for the two involved units also, which I did.

Refer to the attached log for details.

13 DATE / TIME OF REPORT 3-23-03 / 0230	14 REPORTING OFFICER / ID NO / DIV / UNIT FAST 3220 / W0 / cm PD	15 APPROVED BY / ID NO A. Lopez / 2486
--------------------------------------------	---------------------------------------------------------------------	-------------------------------------------

NARRATIVE REPORT VENTURA COUNTY SHERIFF'S DEPARTMENT

Page 2 of 6 Continuation

AGENCY IDENTIFIER CA0560000

1 R.D. 3262	2 BEAT 3C2	3 RB NUMBER 2003-8235
-----------------------	----------------------	---------------------------------

4 CODE	5 ITEM	6 QTY.	7 ITEM NAME	8 BRAND / MAKE MANUFACTURER	9 MODEL NAME OR NUMBER	10 MISC. DESCRIPTION	11 IDENTIFICATION / SERIAL NUMBER	12 VALUE
--------	--------	--------	-------------	-----------------------------	------------------------	----------------------	-----------------------------------	----------

TIME IN	TIME OUT	NAME/ I.D.	ASSIGNMENT	REASON
1921	1936	Sr. Dep. J. Stephens #2743	3C51	Suicidal Subject Stop
1921	1936	Deputy Cerio #3415	3D51	Assist 3C51
1923	2236	Sr. Deputy Heersche #1312	5G11	Assist 3C51 & 3D51
1923	2236	Deputy McConville #3419	5G11	Assist 3C51 & 3D51
1929	1957	Deputy Mulrooney #3283	3C22	Primary Back-Up/ took witness statements from people parked in lot.
1930	1932	[REDACTED]	Federal Fire #72	E.M.S.
1930	1932	[REDACTED]	Federal Fire #72	E.M.S.
1930	1932	[REDACTED]	Federal Fire #72	E.M. S.
1930	1932	[REDACTED]	Federal Fire #72	E. M.S.
1935	1937	Sgt. J. Miller #1968	5I	Assist
2048	2103	Det. Rivera #2096	Major Crimes	Investigation
2048	2103	Sgt. Powers #1365	Major Crimes	Investigation
2048	2100	Sgt. Ayub #3318	Major Crimes	Investigation
2048	2057	SST. [REDACTED] #3322	CSI	Evidence Collection
2048	2103	SST. [REDACTED] #3832	CSI	Evidence Collection
2048	2103	Cadet [REDACTED] #4008	CSI	Evidence Collection
2048	2124	Sgt. Montagna #1047	Major Crimes	Investigation
2055	2100	Capt. Fadler #0684	Major Crimes	Investigation
2057	2100	Sgt. M. Smith #2622	Major Crimes	Investigation
2057	2100	Det. D. Rubright #1935	Major Crimes	Investigation
2058	2100	Cmdr. Purnell #0870	Major Crimes	Investigation
2103	2147	Sgt. Ayub #3318	Major Crimes Unit	Investigation
2103	2116	SST. [REDACTED] #3832	CSI	Evidence Collection
2104	2231	Det. Rivera #2096	Major Crimes Unit	Investigation
2105	2116	Cadet [REDACTED] #4008	CSI	Evidence Processing
2105	2107	Sgt. M. Smith #2622	Major Crimes Unit	Investigation

13 DATE / TIME OF REPORT 3-23-03 / 0230	14 REPORTING OFFICER / ID NO / DIV / UNIT FAST 3220 / WUP / COM PD	15 APPROVED BY / ID NO A. Ayub / 2486
---------------------------------------------------	------------------------------------------------------------------------------	-------------------------------------------------

NARRATIVE REPORT VENTURA COUNTY SHERIFF'S DEPARTMENT

Page 3 of 6 Continuation

AGENCY IDENTIFIER CA0560000

1 R.D. 3262	2 BEAT 3C2	3 RB NUMBER 2003-8235
-----------------------	----------------------	---------------------------------

4 CODE	5 ITEM	6 QTY.	7 ITEM NAME	8 BRAND / MAKE MANUFACTURER	9 MODEL NAME OR NUMBER	10 MISC. DESCRIPTION	11 IDENTIFICATION / SERIAL NUMBER	12 VALUE
--------	--------	--------	-------------	-----------------------------	------------------------	----------------------	-----------------------------------	----------

TIME IN	TIME OUT	NAME/ I.D.	ASSIGNMENT	REASON
2107	2117	Capt. Fadler #0684	Major Crimes Unit	Investigation
2107	2121	Sgt. Powers #1365	Major Crimes	Investigation
2109	2117	Cmdr. Purnell #0870	Major Crimes	Investigation
2110	2130	SST. ██████ #3322	CSI	Evidence Processing
2110	2150	Sgt. M. Smith #2622	Major Crimes	Investigation
2117	2135	Cadet ██████ #4008	CSI	Evidence Processing
2117	2120	Mike ██████ #44	Medical Examiner	Investigation
2117	2131	SST. ██████ #3832	CSI	Evidence Processing
2118	2119	Cmdr. Purnell #0870	Major Crimes	Investigation
2118	2119	Capt. Fadler #0684	Major Crimes	Investigation
2120	2121	██████████ #0701	PIO	Press Release
2122	2123	██████████	PIO	Press Release
2132	2146	Det. D. Rubright #1935	Major Crimes	Investigation
2132	2235	Sgt. Montagna #1047	Major Crimes	Investigation
2134	2144	SST. ██████ #3832	CSI	Evidence Processing
2147	2235	SST. ██████ #3832	CSI	Evidence Processing
2149	2235	Sgt. Obregon #1282	CSI	Evidence Processing
2157	2226	Det. D. Rubright #1935	Major Crimes	Investigation
2200	2244	Sgt. M. Smith #2622	Major Crimes	Investigation
2201	2250	Capt. Fadler #0684	Major Crimes	Investigation
2207	2248	Sgt. Ayub #3318	Major Crimes	Investigation
2210	2310	Dave Stone #7	D.A. Investigator	Investigation
2213	2248	Det. Place #1393	Major Crimes	Investigation
2213	2221	Cmdr. Purnell #0870	Major Crimes	Investigation
2222	2301	John West #238	Deputy D.A.	Investigation
2233	2301	Det. D. Rubright #1935	Major Crimes	Investigation
2237	2255	Det. Rivera #2096	Major Crimes	Investigation
2237	2303	Capt. Fadler #0684	Major Crimes	Investigation
2237	2245	Cmdr. Purnell #0870	Major Crimes	Investigation
2237	2301	Sgt. Montagna #1047	Major Crimes	Investigation
2239	2251	Cadet ██████ #4008	CSI	Evidence Processing
2239	2251	SST. ██████ #3832	CSI	Evidence Processing
2242	2247	Chief Deputy Honorico #0949	VSO	Investigation
2252	2256	Cmdr. Purnell #0870	Major Crimes	Investigation
2253	2254	Cadet ██████ #4008	CSI	Evidence Processing
2253	2255	Det. Place #1393	Major Crimes	Investigation
2259	2300	Cmdr. Purnell #0870	Major Crimes	Investigation
2303	2310	John West #238	Deputy D.A.	Investigation
2310	2316	Sgt. Montagna #1047	Major Crimes	Investigation

13 DATE / TIME OF REPORT <u>3-23-03 / 0230</u>	14 REPORTING OFFICER / ID NO / DIV / UNIT <u>FAST 3220 / WCP / Cam PD</u>	15 APPROVED BY / ID NO <u>J. Ayub / 2486</u>
---------------------------------------------------	------------------------------------------------------------------------------	-------------------------------------------------

NARRATIVE REPORT VENTURA COUNTY SHERIFF'S DEPARTMENT

Page 4 of 6 Continuation

AGENCY IDENTIFIER CA0560000

1 R.D. 3262	2 BEAT 3C2	3 RB NUMBER 2003-8235
-----------------------	----------------------	---------------------------------

4 CODE	5 ITEM	6 QTY.	7 ITEM NAME	8 BRAND / MAKE MANUFACTURER	9 MODEL NAME OR NUMBER	10 MISC. DESCRIPTION	11 IDENTIFICATION / SERIAL NUMBER	12 VALUE
--------	--------	--------	-------------	-----------------------------	------------------------	----------------------	-----------------------------------	----------

TIME IN	TIME OUT	NAME/ I.D.	ASSIGNMENT	REASON
2310	2316	[REDACTED]	Medical Examiner	Investigation
2310	2311	Det. D. Rubright #1935	Major Crimes	Investigation
2320	2330	Mike [REDACTED] #44	Medical Examiner	Investigation
2320	2330	Det. D. Rubright #1935	Major Crimes	Investigation
2326	2328	Det. Rivera #2096	Major Crimes	Investigation
2328	2330	SST. [REDACTED] #3832	CSI	Evidence Processing
2328	2330	Cadet [REDACTED] #4008	CSI	Evidence Processing
2337	2342	[REDACTED]	Medical Examiner	Investigation
2340	0025	[REDACTED]	CSI	Evidence Processing
2345	2352	Mike [REDACTED] #44	Medical Examiner	Investigation
2346	0040	SST. [REDACTED] #3832	CSI	Evidence Processing
2359	0040	Cadet [REDACTED] #4008	CSI	Evidence Processing
2359	0040	Sgt. Obregon #1282	CSI	Evidence Processing
0001	0010	Det. Rivera #2096	Major Crimes	Investigation
0001	0010	Mike [REDACTED] #44	Medical Examiner	Investigation
0002	0010	Dave Stone #7	D.A. Investigator	Investigation
0002	0010	John West #238	Deputy D. A.	Investigation
0006	0007	Det. Place #1393	Major Crimes	Investigation
0006	0007	Sr. Deputy J. Popp #2277	Camarillo Traffic	Laser Measurements
0008	0016	Det. Place #1393	Major Crimes	Investigation
0008	0016	Sgt. Montagna #1047	Major Crimes	Investigation
0008	0010	Det. D. Rubright #1935	Major Crimes	Investigation
0008	0016	Sr. Deputy J. Popp #2277	Camarillo Traffic	Laser Measurements
0014	0016	Det. D. Rubright #1935	Major Crimes	Investigation
0014	0023	Mike [REDACTED] #44	Medical Examiner	Investigation
0015	0038	Sgt. Ayub #3318	Major Crimes	Investigation
0019	0050	Sr. Deputy J. Popp #2277	Camarillo Traffic	Laser Measurements
0019	0040	Det. Place #1393	Major Crimes	Investigation
0030	0040	SST. [REDACTED] #3322	CSI	Evidence Processing
0043	0050	Det. Place #1393	Major Crimes	Investigation
0045	0050	Det. D. Rubright #1935	Major Crimes	Investigation
0048	0049	Det. Rivera #2096	Major Crimes	Investigation
0053	0100	Sr. Deputy J. Popp #2277	Camarillo Traffic	Laser Measurements
0054	0100	Det. Place #1393	Major Crimes	Investigation
0055	0100	Det. D. Rubright #1935	Major Crimes	Investigation
0100	0124	Dave Stone #7	D.A. Investigator	Scene walk-through with Deputy Cerio
0100	0124	John West #238	Deputy D.A.	Scene walk-through with Deputy Cerio

13 DATE / TIME OF REPORT <u>3-23-03 / 0230</u>	14 REPORTING OFFICER / ID NO / DIV / UNIT <u>FAST 3220 / WCP / CAN PD</u>	15 APPROVED BY / ID NO <u>[Signature] / 2486</u>
---------------------------------------------------	------------------------------------------------------------------------------	-----------------------------------------------------

NARRATIVE REPORT VENTURA COUNTY SHERIFF'S DEPARTMENT

Page 5 of 6 Continuation

AGENCY IDENTIFIER CA0560000

1 R.D. 3262	2 BEAT 3C2	3 RB NUMBER 2003-8235
-----------------------	----------------------	---------------------------------

4 CODE	5 ITEM	6 QTY.	7 ITEM NAME	8 BRAND / MAKE MANUFACTURER	9 MODEL NAME OR NUMBER	10 MISC. DESCRIPTION	11 IDENTIFICATION / SERIAL NUMBER	12 VALUE
--------	--------	--------	-------------	-----------------------------	------------------------	----------------------	-----------------------------------	----------

TIME IN	TIME OUT	NAME/ I.D.	ASSIGNMENT	REASON
0100	0116	SST. ██████ #3322	CSI	Scene walk-through with Deputy Cerio
0100	0120	Ken Yuwiler	LDF Attorney	Scene walk-through with Deputy Cerio
0100	0119	Alan Wisotsky	County Attorney	Scene walk-through with Deputy Cerio
0100	0125	Rick Shimmel	VCDSA	Scene walk-through with Deputy Cerio
0100	0116	Sgt. E. Dowd #2550	VSO I.A.	Scene walk-through with Deputy Cerio
0100	0125	Sgt. Montagna #1047	Major Crimes	Scene walk-through with Deputy Cerio
0100	0116	Deputy Cerio #3415	WCP/ D Station	Scene walk-through
0100	0333	Det. Rivera #2096	Major Crimes	Investigation
0119	0125	Capt. Fadler #0684	Major Crimes	Investigation
0123	0125	Sgt. E. Dowd #2550	VSO I.A.	Investigation
0127	0205	Sr. Deputy J. Popp #2277	Camarillo Traffic	Laser Measurements
0127	0207	Det. Place #1393	Major Crimes	Investigation
0130	0132	Det. D. Rubright #1935	Major Crimes	Investigation
0130	0141	Sgt. Montagna #1047	Major Crimes	Investigation
0130	0210	Jim ██████	Forensic Scientist, VSO	Investigation
0132	0210	Sgt. Ayub #3318	Major Crimes	Investigation
0138	0303	Cadet ██████ #4008	CSI	Evidence Processing
0140	0142	Sgt. Obregon #1282	CSI	Evidence Processing
0142	0303	SST. ██████ #3322	CSI	Evidence Processing
0142	0303	SST. ██████ #3832	CSI	Evidence Processing
0145	0150	Sgt. Montagna #1047	Major Crimes	Investigation
0153	0210	Sgt. Montagna #1047	Major Crimes	Investigation
0203	0320	Mike ██████ #44	Medical Examiner	Investigation
0215	0315	Jim ██████	Forensic Scientist, VSO	Investigation
0220	0225	Sgt. Montagna #1047	Major Crimes	Investigation
0235	0243	Sgt. Montagna #1047	Major Crimes	Investigation
0235	0250	Sgt. Obregon #1282	CSI	Evidence Processing
0251	0305	Sgt. Obregon #1282	CSI	Evidence Processing
0255	0325	Sgt. Montagna #1047	Major Crimes	Investigation
0305	0315	██████████	Coroner Transport	Remove Body
0305	0315	██████████	Coroner Transport	Remove Body
0311	0450	SST. ██████ #3832	CSI	Evidence Processing
0313	0450	SST. ██████ #3322	CSI	Evidence Processing

13 DATE / TIME OF REPORT 3-23-03 / 0230	14 REPORTING OFFICER / ID NO / DIV / UNIT FAST #3220 / WCP / CAM PD	15 APPROVED BY / ID NO A. Ayub / 2486
---------------------------------------------------	-------------------------------------------------------------------------------	-------------------------------------------------

VENTURA COUNTY SHERIFF'S DEPARTMENT

REQUEST FOR TAPE REPRODUCTION
(Applies to Sheriff's Radio and Telephone Communications only)

(MANDATORY INFORMATION)

Sheriff's Report No. 03-20-03 Date/Time of Incident 3-20-03/1850

Location of Incident [REDACTED]

Specify Streets and Addresses _____

Geographical Area or City CAMARILLO

Purpose of Request CRIMINAL

Tape Reproduction of: Radio Telephone Call Number of Recordings 1

Date/Time (Inclusive) of Recording _____

Defendant's Name(s) PEARLMAN, Nancy

Officer(s) by Car/Beat Assignment(s) 8J51 (Johnson)
8B11 (Hollowell)

Additional Instructions/Information/Requests DA REQUEST RADIO TRAFFIC PRECEEDING
MOOTING - BEGIN RECORDING @ 1845 TO 1905

Person Requesting Sgt. MONTAGNA _____
PRINT NAME SIGNATURE

BUSINESS OR FIRM PHONE NUMBER DATE OF REQUEST

NOTE: All requests for Tape Reproductions will require a MINIMUM of two(2) working days.

PAYMENT: The Board of Supervisors requires that an appropriate fee be charged for this service. At the time you submit your request for Tape Reproduction you will be given an estimated cost for the service. The actual cost to complete your request will be based on the time required. Payment by cash or check payable to "Ventura County Sheriff" must be received prior to releasing the Tape Reproduction(s).

FOR OFFICIAL USE ONLY

Date/Time Request Received _____ Employee _____
NAME AND ID NUMBER

Date Reproduction Completed _____

Reproduction Completed by _____
NAME, RANK AND ID NUMBER SIGNATURE

Date Reproduction Released _____ Time Reproduction Released _____

Released to (Print) _____
SIGNATURE

Amount Paid _____ Cash Check

Receipt Number or Check Number _____

Calls for Service Summary

E911: 03/20/2003 18:49:18
Received: 03/20/2003 18:42:48
Entry: 03/20/2003 18:49:18
Dispatch: 03/20/2003 18:51:23
Arrival: 03/20/2003 19:05:46
Cleared: 03/21/2003 04:51:35

Call Nbr: 030790833
RB Nbr: 030008235
Disposition: Report
Final Call Type: Suicidal Subject
Original Call Type:

Location

Cross Street

Location Comments:

Reporting P

RP Add

Jurisdic

Prior Nbr Calls:

Primary Unit: 8J51

Duplicate CFS:

Priority: Emergency

Premise Hazard:

Status Date:	Status:	Comments:
03/20/2003 18:49:18	E911	[REDACTED]
03/20/2003 18:49:18	Entry	[REDACTED]
03/20/2003 18:50:37	Supplemental Information	[REDACTED]
03/20/2003 18:51:23	Dispatch-Enroute	8J51
03/20/2003 18:51:23	ID	8J51 <3267>BRENT JOHNSON
03/20/2003 18:52:42	Backup-Enroute	8J51 8B11
03/20/2003 18:52:42	ID	8B11 <3612>WILLIAM HOLLOWELL
03/20/2003 18:52:58	Misc. Comment Continous	LASO ADV
03/20/2003 18:54:56	Misc. Comment Continous	8J51, INFO BCAST TO WEST COUNTY UNITS
03/20/2003 18:55:06	Supplemental Information	TEXT:CHP ADV
03/20/2003 18:55:59	Misc. Comment Continous	[REDACTED]
03/20/2003 18:56:31	Misc. Comment Continous	8J51, INFO BCASTED TO EV UNITS
03/20/2003 18:57:00	Misc. Comment Continous	CAM LATE CARS ADVISED FOR BREIFING
03/20/2003 18:59:03	Clear	8B11
03/20/2003 18:59:05	Backup-Enroute	8J51 8B11
03/20/2003 18:59:05	ID	8B11 <3612>WILLIAM HOLLOWELL
03/20/2003 18:59:09	Backup-Enroute	8J51 8C11
03/20/2003 18:59:09	ID	8C11 <1541>NOEL SANJOSE
03/20/2003 19:00:38	Supplemental Information	TEXT:PER RP SUBJ POSS ENR TO MUGU ROCK/ RP ATTEMPTING TOCONTACT ONSTAR FOR A LOC OF THE TARGE [REDACTED]
03/20/2003 19:01:03	Backup-Enroute	8J51 3C51
03/20/2003 19:01:03	ID	3C51 <2743>JASON STEPHENS
03/20/2003 19:02:11	Change Location	3C51 MUGU ROCK
03/20/2003 19:05:46	On Scene	8B11

E911: 03/20/2003 18:49:18
Received: 03/20/2003 18:42:48
Entry: 03/20/2003 18:49:18
Dispatch: 03/20/2003 18:51:23
Arrival: 03/20/2003 19:05:46
Cleared: 03/21/2003 04:51:35

Call Nbr: 030790833
RB Nbr: 030008235
Disposition: Report
Final Call Type: Suicidal Subject
Original Call Type:

Location:
Rep:

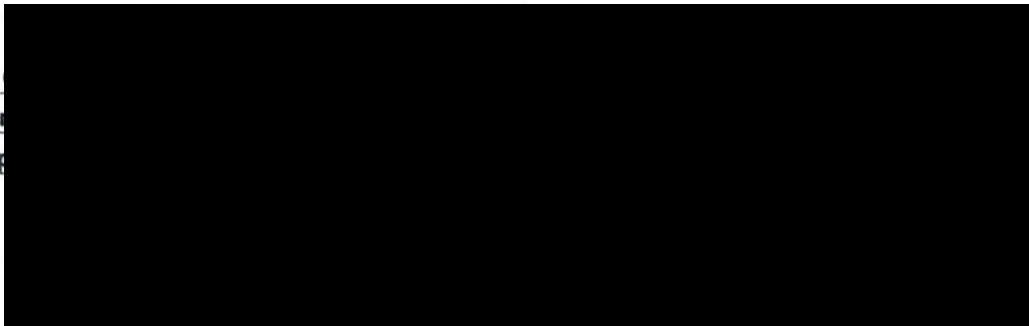

CFS:
Priority: Emergency

Prior Nbr Calls: Primary Unit: 8J51 Premise Hazard:

Status Date:	Status:	Comments:
03/20/2003 19:05:48	On Scene	8C11
03/20/2003 19:07:53	On Scene	8J51
03/20/2003 19:08:04	Misc. Comment Continous	HARDY AT D STATION ADV'D OF CALL INFO/OFFICER SAFETY
03/20/2003 19:08:44	Misc. Comment Continous	8J51, RP UNABLE TO ACTIVATE ONSTAR FROM THE HOUSE
03/20/2003 19:09:47	Backup-Enroute	3C51 3D51
03/20/2003 19:09:47	ID	3D51 <3415>STEVEN CERIO
03/20/2003 19:09:55	Misc. Comment Continous	3C51, SO CO
03/20/2003 19:14:13	Misc. Comment Continous	3C51, 1/4 MILE
03/20/2003 19:14:43	Misc. Comment Continous	3D51, 1/4 MILE PAST MUGU ROCK
03/20/2003 19:14:52	Backup-Enroute	3C51 5G21
03/20/2003 19:14:52	ID	5G21 <3126>MICHAEL MARCO <2347>WILLIAM SCHIERMAN
03/20/2003 19:14:59	Misc. Comment Continous	5G21, RESPONDING CODE
03/20/2003 19:15:12	Misc. Comment Continous	3C51, HAS THE VEH 1/4 PAST MUGU ROCK
03/20/2003 19:16:15	Backup-Enroute	3C51 8G41, FOR CIT
03/20/2003 19:16:15	ID	[REDACTED]
03/20/2003 19:16:31	Misc. Comment Continous	3C51, ATTEMPTING TO MOVE
03/20/2003 19:16:36	Backup-Enroute	3C51 5G11
03/20/2003 19:16:36	ID	5G11 <3419>MICHAEL MCCONVILLE <1312>ALLAN HEERSCHE
03/20/2003 19:17:19	Misc. Comment Continous	3C51, NEG ON ILLEGAL INTERVENTION
03/20/2003 19:17:37	Backup-Enroute	3C51 3C22
03/20/2003 19:17:37	ID	3C22 <3283>JOSEPH MULROONEY
03/20/2003 19:17:42	Misc. Comment Continous	3C22, RES CODE
03/20/2003 19:17:46	Misc. Comment Continous	5G21, RES CODE
03/20/2003 19:18:43	Misc. Comment Continous	3D51, SUBJ IN VEH UNCOOPERATIVE/SUBJ RESPONSIVE
03/20/2003 19:18:55	Backup-Enroute	3D51 3DK

E911: 03/20/2003 18:49:18
Received: 03/20/2003 18:42:48
Entry: 03/20/2003 18:49:18
Dispatch: 03/20/2003 18:51:23
Arrival: 03/20/2003 19:05:46
Cleared: 03/21/2003 04:51:35

Call Nbr: 030790833
RB Nbr: 030008235
Disposition: Report
Final Call Type: Suicidal Subject
Original Call Type:

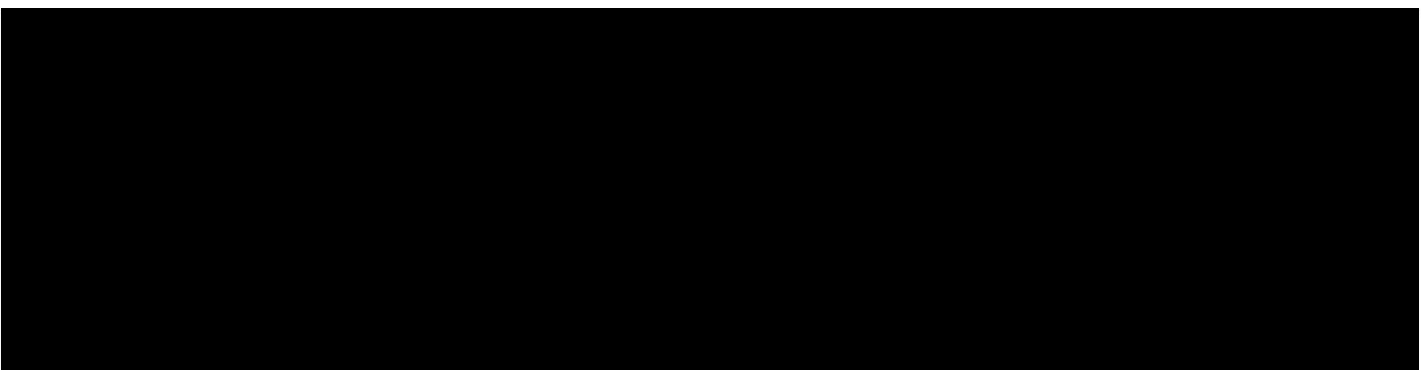

Status Date:	Status:	Comments:
03/20/2003 19:18:55	ID	3DK <2555>CLIFFORD HARDY
03/20/2003 19:19:13	Clear	8G41
03/20/2003 19:19:20	Backup-Enroute	3D51 8G41
03/20/2003 19:19:20	ID	8G41 <3354>BEATRICE NORTON
03/20/2003 19:19:58	Misc. Comment Continous	3C51, SB PCH PASSED MUGU ROCK
03/20/2003 19:20:05	Clear	8B11
03/20/2003 19:20:10	Clear	8C11
03/20/2003 19:20:18	Misc. Comment Continous	3C51, F SUBJ IS ANIMAL LOVER
03/20/2003 19:20:32	Misc. Comment Continous	3D51, SUBJ NOT COMPLYING/REFUSING TO COME OUT
03/20/2003 19:21:14	Misc. Comment Continous	8J51, ADVISED SUBJ IS AN ANIMAL LOVER / 3DK IS A GOOD OPTION AT THIS TIME
03/20/2003 19:21:29	Misc. Comment Continous	3C51, SHOTS FIRED
03/20/2003 19:21:36	Misc. Comment Continous	5G11, 5 OUT SOCO
03/20/2003 19:22:08	Backup-Enroute	3C51 5G23
03/20/2003 19:22:08	ID	5G23 <2605>KEVIN CLANCY <3544>MATTHEW YOUNG
03/20/2003 19:22:23	Backup-Enroute	3C51 CAR12
03/20/2003 19:22:23	ID	CAR12 <1186>DAVID TENNESSEN
03/20/2003 19:22:34	Misc. Comment Continous	[REDACTED]
03/20/2003 19:22:46	Misc. Comment Continous	3D51, ROLL FIRE/AMB HEAD WOUND
03/20/2003 19:23:32	On Scene	5G11
03/20/2003 19:24:49	On Scene	5G21
03/20/2003 19:27:13	Misc. Comment Continous	3C22, 10-6 SOCO
03/20/2003 19:27:34	Backup-Enroute	3C51 3S19
03/20/2003 19:27:34	ID	3S19 <2063>HAROLD HANLEY
03/20/2003 19:27:53	Backup-Enroute	3C51 5G10

E911: 03/20/2003 18:49:18
Received: 03/20/2003 18:42:48
Entry: 03/20/2003 18:49:18
Dispatch: 03/20/2003 18:51:23
Arrival: 03/20/2003 19:05:46
Cleared: 03/21/2003 04:51:35

Call Nbr: 030790833
RB Nbr: 030008235
Disposition: Report
Final Call Type: Suicidal Subject
Original Call Type:

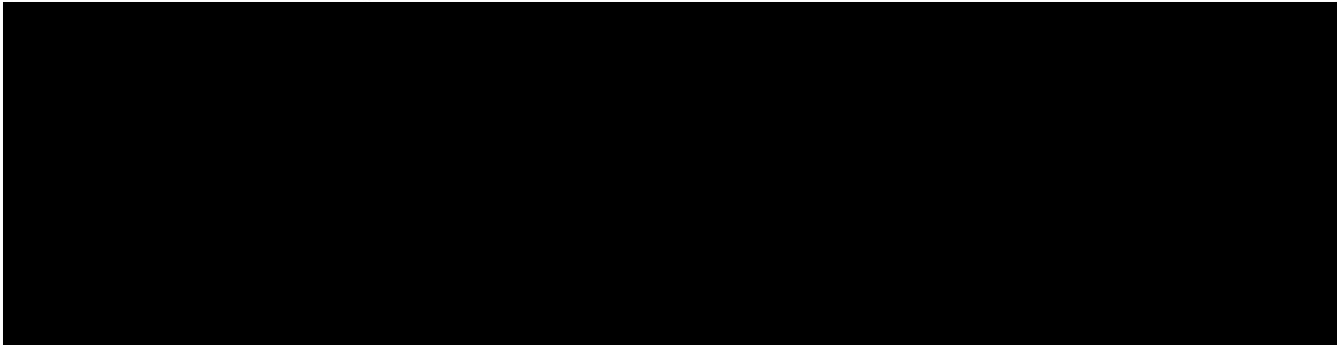

Status Date:	Status:	Comments:
03/20/2003 19:27:53	ID	5G10 <1998>DAVID LAREVA
03/20/2003 19:27:55	Clear	8G41
03/20/2003 19:29:28	Misc. Comment Continous	3C22, CURRENT 1020 MUGU BEACH NO OF MUGU ROCK
03/20/2003 19:30:32	Backup-Enroute	3C51 3D52
03/20/2003 19:30:32	ID	3D52 <3018>DAVID SCHWIEDER
03/20/2003 19:30:46	Supplemental Information	TEXT:ACTUAL LOCATION IS MAGU BEACH JUST NORTH OF MAGU ROCK
03/20/2003 19:31:05	Backup-Enroute	3D52 3D22
03/20/2003 19:31:05	ID	3D22 <3358>EDWIN TUAZON
03/20/2003 19:31:37	Backup-Onscene	3C51 3C21
03/20/2003 19:31:37	ID	3C21 <3220>BRENT FAST
03/20/2003 19:32:16	Case	3D51 SO0300008235 Assigned
03/20/2003 19:32:37	Misc. Comment Continous	3C51, OIS/SUBJ DOWN WOUND TO HEAD/DOA
03/20/2003 19:33:20	Misc. Comment Continous	CAR12, 10-6 SOCO
03/20/2003 19:33:47	Misc. Comment Continous	3D52, 10-6 SOCO
03/20/2003 19:33:56	Misc. Comment Continous	5G21, 10-6 SOCO
03/20/2003 19:34:18	On Scene	CAR12
03/20/2003 19:34:22	On Scene	5G23
03/20/2003 19:36:16	Misc. Comment Continous	3DK, 10-6 SOCO
03/20/2003 19:36:19	On Scene	3D52
03/20/2003 19:36:34	Supplemental Information	TEXT:PER DEP SHIREMAN, CHP IS ER TO ASSIST WITH TRAFFIC CONTROL
03/20/2003 19:36:36	Transfer	@CDAREA:WEST-->TAC2
03/20/2003 19:37:33	On Scene	3C51
03/20/2003 19:37:36	On Scene	3C22
03/20/2003 19:37:40	On Scene	3D51

E911: 03/20/2003 18:49:18
Received: 03/20/2003 18:42:48
Entry: 03/20/2003 18:49:18
Dispatch: 03/20/2003 18:51:23
Arrival: 03/20/2003 19:05:46
Cleared: 03/21/2003 04:51:35

Call Nbr: 030790833
RB Nbr: 030008235
Disposition: Report
Final Call Type: Suicidal Subject
Original Call Type:

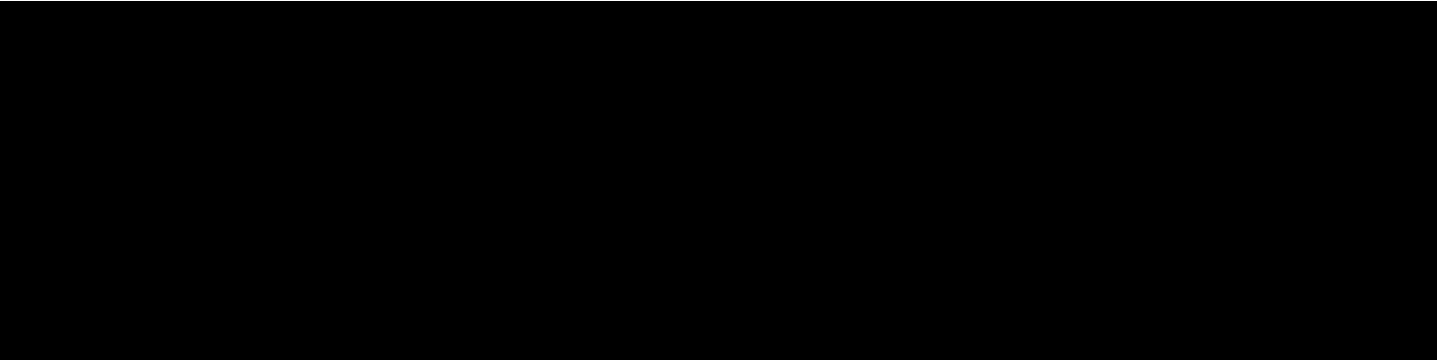

Status Date:	Status:	Comments:
03/20/2003 19:37:44	On Scene	3D22
03/20/2003 19:37:46	On Scene	3DK
03/20/2003 19:38:45	Backup-Enroute	3D51 5I
03/20/2003 19:38:45	ID	5I <1968>JOHN MILLER
03/20/2003 19:39:01	On Scene	5I
03/20/2003 19:39:59	Misc. Comment Continous	3S19, 10-6 SOCO
03/20/2003 19:40:14	Misc. Comment Continous	3C51, STOPPING TRAFFIC HEADING NORTH
03/20/2003 19:41:22	Clear	3DK
03/20/2003 19:42:41	On Scene	3S19
03/20/2003 19:44:42	Backup-Enroute	5G10 5H16
03/20/2003 19:44:42	ID	5H16 <3318>WILLIAM AYUB
03/20/2003 19:45:53	Backup-Enroute	5G10 5H13
03/20/2003 19:45:53	ID	5H13 <1935>DEBORAH RUBRIGHT
03/20/2003 19:47:11	Recontact	3C21
03/20/2003 19:47:11	Recontact	5G11
03/20/2003 19:47:11	Recontact	5G21
03/20/2003 19:47:11	Recontact	5G23
03/20/2003 19:47:11	Recontact	CAR12
03/20/2003 19:48:56	Recontact	3C22
03/20/2003 19:48:56	Recontact	3C51
03/20/2003 19:48:56	Recontact	3D22
03/20/2003 19:48:56	Recontact	3D51
03/20/2003 19:49:00	Recontact	3D51
03/20/2003 19:50:29	On Scene	5G10
03/20/2003 19:57:48	Misc. Comment Continous	5G23, PIO ENR

E911: 03/20/2003 18:49:18
Received: 03/20/2003 18:42:48
Entry: 03/20/2003 18:49:18
Dispatch: 03/20/2003 18:51:23
Arrival: 03/20/2003 19:05:46
Cleared: 03/21/2003 04:51:35

Call Nbr: 030790833
RB Nbr: 030008235
Disposition: Report
Final Call Type: Suicidal Subject
Original Call Type:

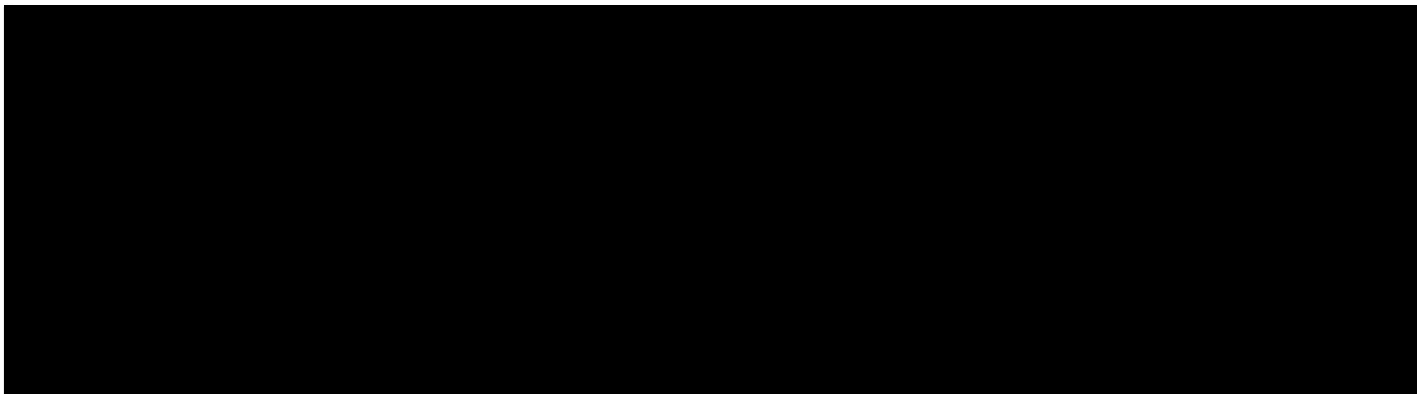

Status Date:	Status:	Comments:
03/20/2003 19:58:21	Backup-Onscene	3C51 5H2
03/20/2003 19:58:21	ID	5H2 <2622>MELISSA SMITH
03/20/2003 20:00:21	Recontact	3D52
03/20/2003 20:00:26	Recontact	5I
03/20/2003 20:00:43	Backup-Enroute	3C51 5H17
03/20/2003 20:00:43	ID	5H17 <2696>JOSE RIVERA
03/20/2003 20:00:52	Misc. Comment Continous	5I, LIFT 33
03/20/2003 20:01:23	On Scene OK	5I
03/20/2003 20:01:23	On Scene OK	5H2
03/20/2003 20:01:23	On Scene OK	3C21
03/20/2003 20:01:23	On Scene OK	3C22
03/20/2003 20:01:23	On Scene OK	3C51
03/20/2003 20:01:23	On Scene OK	3D22
03/20/2003 20:01:23	On Scene OK	3D51
03/20/2003 20:01:23	On Scene OK	3D52
03/20/2003 20:01:23	On Scene OK	3S19
03/20/2003 20:01:23	On Scene OK	5G10
03/20/2003 20:01:23	On Scene OK	5G11
03/20/2003 20:01:23	On Scene OK	5G21
03/20/2003 20:01:23	On Scene OK	5G23
03/20/2003 20:01:23	On Scene OK	CAR12
03/20/2003 20:01:29	On Scene OK	8J51
03/20/2003 20:02:52	Transfer	@CDAREA:TAC2-->WEST
03/20/2003 20:03:21	On Scene	5H16
03/20/2003 20:04:22	Backup-Enroute	3C51 1114

Calls for Service Summary

E911: 03/20/2003 18:49:18
Received: 03/20/2003 18:42:48
Entry: 03/20/2003 18:49:18
Dispatch: 03/20/2003 18:51:23
Arrival: 03/20/2003 19:05:46
Cleared: 03/21/2003 04:51:35

Call Nbr: 030790833
RB Nbr: 030008235
Disposition: Report
Final Call Type: Suicidal Subject
Original Call Type:

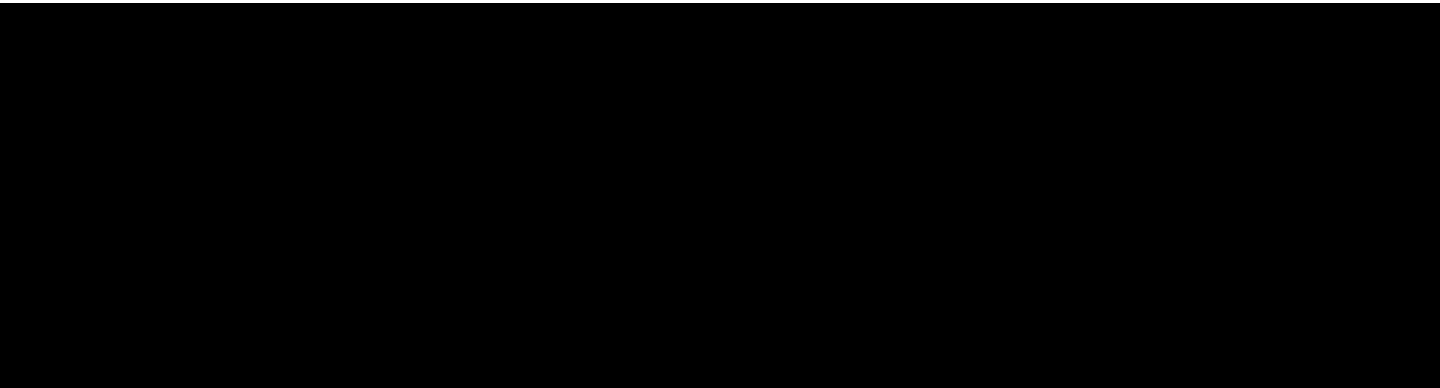

<u>Status Date:</u>	<u>Status:</u>	<u>Comments:</u>
03/20/2003 20:04:22	ID	1114 <2550>ERIC DOWD
03/20/2003 20:07:45	On Scene	5H13
03/20/2003 20:08:41	Misc. Comment Continous	5G11, RD 3262 3C02 BEAT
03/20/2003 20:14:19	On Scene	5H17
03/20/2003 20:19:13	Backup-Enroute	3C51 5E2 5E5
03/20/2003 20:19:13	ID	[REDACTED]
03/20/2003 20:19:13	ID	[REDACTED]
03/20/2003 20:19:47	Backup-Onscene	3C51 5H1
03/20/2003 20:19:47	ID	5H1 <1365>MICHAEL POWERS
03/20/2003 20:25:49	Recontact	5H13
03/20/2003 20:25:49	Recontact	5H16
03/20/2003 20:25:49	Recontact	5H17
03/20/2003 20:27:41	On Scene	1114
03/20/2003 20:40:50	On Scene	5E2
03/20/2003 20:40:50	On Scene	5E5
03/20/2003 20:41:25	Recontact	5H1
03/20/2003 20:41:25	Recontact	1114
03/20/2003 20:54:41	Recontact	5E2
03/20/2003 20:54:41	Recontact	5E5
03/20/2003 21:00:54	Backup-Enroute	3C51 CAMCP
03/20/2003 21:17:03	Clear	5G23
03/20/2003 21:31:40	Backup-Enroute	3C51 1112
03/20/2003 21:31:40	ID	1112 <1794>JAMES KENNEY
03/20/2003 21:49:19	Clear	CAR12
03/20/2003 22:00:53	On Scene	CAMCP

E911: 03/20/2003 18:49:18
Received: 03/20/2003 18:42:48
Entry: 03/20/2003 18:49:18
Dispatch: 03/20/2003 18:51:23
Arrival: 03/20/2003 19:05:46
Cleared: 03/21/2003 04:51:35

Call Nbr: 030790833
RB Nbr: 030008235
Disposition: Report
Final Call Type: Suicidal Subject
Original Call Type:

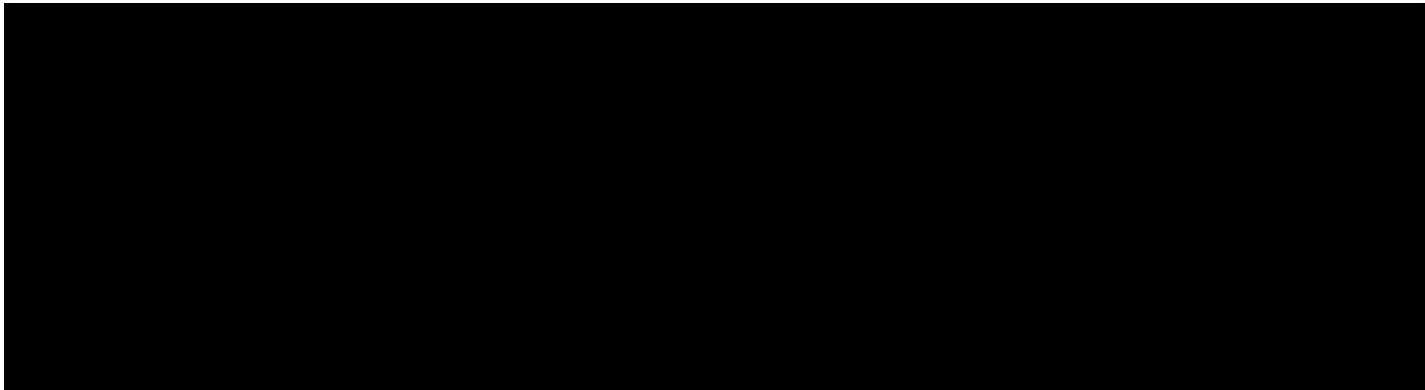

Status Date:	Status:	Comments:
03/20/2003 22:05:42	Recontact	11I2
03/20/2003 22:16:59	On Scene	11I2
03/20/2003 22:17:20	Clear	5G21
03/20/2003 22:24:12	Misc. Comment Continous	8J51, REQ 8I TO 1198 W/ DIGITAL CAMERA
03/20/2003 22:24:58	Recontact	CAMCP
03/20/2003 22:29:01	Backup-Enroute	8J51 8I51
03/20/2003 22:29:01	ID	8I51 <3584>GARY NIEBERGALL
03/20/2003 22:29:15	Recontact	11I2
03/20/2003 22:31:01	Clear	5G10
03/20/2003 22:37:32	On Scene	8I51
03/20/2003 22:44:16	Clear	5G11
03/20/2003 22:50:04	Recontact	8I51
03/20/2003 23:02:28	Clear	5H2
03/20/2003 23:14:35	Change Location	[REDACTED]
03/20/2003 23:24:52	Change Location Onscene	[REDACTED]
03/20/2003 23:28:26	On Scene	8J51
03/20/2003 23:42:23	Recontact	8J51
03/20/2003 23:45:10	Backup-Enroute	3C51 8T
03/20/2003 23:45:10	ID	8T <2277>JOHN POPP
03/20/2003 23:51:52	Clear	8J51 RPT
03/21/2003 00:00:26	Clear	8I51
03/21/2003 00:37:28	On Scene	8T
03/21/2003 00:57:34	Recontact	8T
03/21/2003 01:23:09	Backup-Enroute	3C22 3CR
03/21/2003 01:23:09	ID	3CR <2913>MARCO HINAHON

Calls for Service Summary

E911: 03/20/2003 18:49:18
Received: 03/20/2003 18:42:48
Entry: 03/20/2003 18:49:18
Dispatch: 03/20/2003 18:51:23
Arrival: 03/20/2003 19:05:46
Cleared: 03/21/2003 04:51:35

Call Nbr: 030790833
RB Nbr: 030008235
Disposition: Report
Final Call Type: Suicidal Subject
Original Call Type:

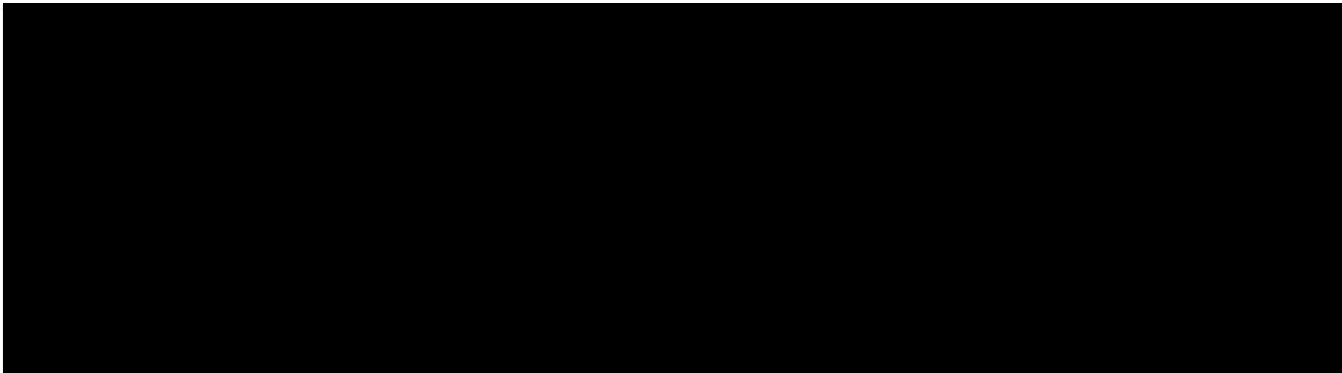

Status Date:	Status:	Comments:
03/21/2003 01:29:30	Misc. Comment Continous	[REDACTED]
03/21/2003 01:31:15	Misc. Comment	.833, 1022 LAST CLEARANCE
03/21/2003 01:52:05	Clear	3D52
03/21/2003 01:55:00	On Scene	3CR
03/21/2003 02:03:25	Clear	5H13
03/21/2003 02:31:05	Recontact	3CR
03/21/2003 02:41:47	Clear	3CR
03/21/2003 02:44:34	Clear	5H16
03/21/2003 03:00:49	Backup-Onscene	3C22 3CR
03/21/2003 03:00:49	ID	3CR <3283>JOSEPH MULROONEY
03/21/2003 03:37:09	Recontact	3CR
03/21/2003 03:39:08	Misc. Comment Continous	[REDACTED]
03/21/2003 03:41:14	Tow Request	[REDACTED]
03/21/2003 04:30:09	Backup-Enroute	CAMCP 3D23
03/21/2003 04:30:09	ID	3D23 <2409>DAVID SPARKS <3096>PATRICK HARDY
03/21/2003 04:42:59	On Scene	3D23
03/21/2003 04:43:23	Change Location	3D23 800 S VICTORIA AV
03/21/2003 04:50:39	Clear	3CR RPT
03/21/2003 04:50:42	Clear	3C21 RPT
03/21/2003 04:51:10	Clear	3S19
03/21/2003 04:51:14	Clear	CAMCP
03/21/2003 04:51:21	Clear	8T
03/21/2003 04:51:35	Clear	5I RPT
03/21/2003 04:51:35	Close	5I RPT
03/21/2003 04:51:35	Clear	5E2 RPT

Status	Status Date	Entered By	Comments
E	03/20/2003 18:49:18		
E911	03/20/2003 18:49:18		
Supplemental Infor	03/20/2003 18:50:37		
Dispatch-Enroute	03/20/2003 18:51:23	Andrea	8J51
ID	03/20/2003 18:51:23	Andrea	8J51 <3267>BRENT JOHNSON
Backup-Enroute	03/20/2003 18:52:42	Andrea	8J51 8B11
ID	03/20/2003 18:52:42	Andrea	8B11 <3612>WILLIAM HOLLOWELL
Misc. Comment Col	03/20/2003 18:52:58	Bren	LASO ADV
Misc. Comment Col	03/20/2003 18:54:56	Andrea	8J51, INFO BCAST TO WEST COUNTY UNITS
Supplemental Infor	03/20/2003 18:55:06		TEXT:CHP ADV
Misc. Comment Col	03/20/2003 18:55:59	Andrea	
Misc. Comment Col	03/20/2003 18:56:31	Christy	8J51, INFO BCASTED TO EV UNITS
Misc. Comment Col	03/20/2003 18:57:00	Bren	CAM LATE CARS ADVISED FOR BREIFING
Clear	03/20/2003 18:59:03	Andrea	8B11
Backup-Enroute	03/20/2003 18:59:05	Andrea	8J51 8B11
ID	03/20/2003 18:59:05	Andrea	8B11 <3612>WILLIAM HOLLOWELL
Backup-Enroute	03/20/2003 18:59:09	Andrea	8J51 8C11
ID	03/20/2003 18:59:09	Andrea	8C11 <1541>NOEL SANJOSE
Supplemental Infor	03/20/2003 19:00:38		TEXT:PER RP SUBJ POSS ENR TO MUGU ROCK/RR
Backup-Enroute	03/20/2003 19:01:03	Andrea	8J51 3C51
ID	03/20/2003 19:01:03	Andrea	3C51 <2743>JASON STEPHENS
Change Location	03/20/2003 19:02:11	Andrea	3C51 MUGU ROCK
On Scene	03/20/2003 19:05:46	Andrea	8B11
On Scene	03/20/2003 19:05:48	Andrea	8C11
On Scene	03/20/2003 19:07:53	Andrea	8J51
Misc. Comment Col	03/20/2003 19:08:04	thryn	HARDY AT D STATION ADV'D OF CALL INFO/OFFICER SAFETY
Misc. Comment Col	03/20/2003 19:08:44	Andrea	8J51, RP UNABLE TO ACTIVATE ONSTAR FROM THE HOUSE
Backup-Enroute	03/20/2003 19:09:47	Andrea	3C51 3D51
ID	03/20/2003 19:09:47	Andrea	3D51 <3415>STEVEN CERIO

Status	Status Date	Entered By	Comments
Misc. Comment Col	03/20/2003 19:09:55	Andrea	3C51, SO CO
Misc. Comment Col	03/20/2003 19:14:13	Andrea	3C51, 1/4 MILE
Misc. Comment Col	03/20/2003 19:14:43	Andrea	3D51, 1/4 MILE PAST MUGU ROCK
ID	03/20/2003 19:14:52	Andrea	5G21 <3126>MICHAEL MARCO <2347>WILLIAM SCHIERMAN
Backup-Enroute	03/20/2003 19:14:52	Andrea	3C51 5G21
Misc. Comment Col	03/20/2003 19:14:59	Andrea	5G21, RESPONDING CODE
Misc. Comment Col	03/20/2003 19:15:12	Andrea	3C51, HAS THE VEH 1/4 PAST MUGU ROCK
Backup-Enroute	03/20/2003 19:16:15	amara	3C51 8G41, FOR CIT
ID	03/20/2003 19:16:15	amara	8G41 <3354>BEATRICE NORTON
Misc. Comment Col	03/20/2003 19:16:31	Andrea	3C51, ATTEMPTING TO MOVE
Backup-Enroute	03/20/2003 19:16:36	Andrea	3C51 5G11
ID	03/20/2003 19:16:36	Andrea	5G11 <3419>MICHAEL MCCONVILLE <1312>ALLAN HEERSCH
Misc. Comment Col	03/20/2003 19:17:19	Andrea	3C51, NEG ON ILLEGAL INTERVENTION
Backup-Enroute	03/20/2003 19:17:37	Andrea	3C51 3C22
ID	03/20/2003 19:17:37	Andrea	3C22 <3283>JOSEPH MULROONEY
Misc. Comment Col	03/20/2003 19:17:42	Andrea	3C22, RES CODE
Misc. Comment Col	03/20/2003 19:17:46	Andrea	5G21, RES CODE
Misc. Comment Col	03/20/2003 19:18:43	Andrea	3D51, SUBJ IN VEH UNCOOPERATIVE/SUBJ RESPONSIVE
Backup-Enroute	03/20/2003 19:18:55	Andrea	3D51 3DK
ID	03/20/2003 19:18:55	Andrea	3DK <2555>CLIFFORD HARDY
Clear	03/20/2003 19:19:13	Andrea	8G41
Backup-Enroute	03/20/2003 19:19:20	Andrea	3D51 8G41
ID	03/20/2003 19:19:20	Andrea	8G41 <3354>BEATRICE NORTON
Misc. Comment Col	03/20/2003 19:19:58	Andrea	3C51, SB PCH PASSED MUGU ROCK
Clear	03/20/2003 19:20:05	hn	8B11
Clear	03/20/2003 19:20:10	hn	8C11
Misc. Comment Col	03/20/2003 19:20:18	Andrea	3C51, F SUBJ IS ANIMAL LOVER
Misc. Comment Col	03/20/2003 19:20:32	Andrea	3D51, SUBJ NOT COMPLYING/REFUSING TO COME OUT
Misc. Comment Col	03/20/2003 19:21:14	Christy	8J51, ADVISED SUBJ IS AN ANIMAL LOVER / 3DK IS A GOOD OPTION AT THIS TIME
Misc. Comment Col	03/20/2003 19:21:29	Andrea	3C51, SHOTS FIRED
Misc. Comment Col	03/20/2003 19:21:36	Andrea	5G11, 5 OUT SOCO
Backup-Enroute	03/20/2003 19:22:08	Andrea	3C51 5G23
ID	03/20/2003 19:22:08	Andrea	5G23 <2605>KEVIN CLANCY <3544>MATTHEW YOUNG
Backup-Enroute	03/20/2003 19:22:23	Andrea	3C51 CAR12

Status	Status Date	Entered By	Comments
ID	03/20/2003 19:22:23	Andrea	CAR12 <1186>DAVID TENNESSEN
Misc. Comment Coi	03/20/2003 19:22:34	amara	
Misc. Comment Coi	03/20/2003 19:22:46	Andrea	3D51, ROLL FIRE/AMB HEAD WOUND
On Scene	03/20/2003 19:23:32	Andrea	5G11
On Scene	03/20/2003 19:24:49	Andrea	5G21
Misc. Comment Coi	03/20/2003 19:27:13	Andrea	3C22, 10-6 SOCO
Backup-Enroute	03/20/2003 19:27:34	Andrea	3C51 3S19
ID	03/20/2003 19:27:34	Andrea	3S19 <2063>HAROLD HANLEY
ID	03/20/2003 19:27:53	Andrea	5G10 <1998>DAVID LAREVA
Backup-Enroute	03/20/2003 19:27:53	Andrea	3C51 5G10
Clear	03/20/2003 19:27:55	Andrea	8G41
Misc. Comment Coi	03/20/2003 19:29:28	Andrea	3C22, CURRENT 1020 MUGU BEACH NO OF MUGU ROCK
Backup-Enroute	03/20/2003 19:30:32	Andrea	3C51 3D52
ID	03/20/2003 19:30:32	Andrea	3D52 <3018>DAVID SCHWIEDER
Supplemental Inforr	03/20/2003 19:30:46	remy	TEXT:ACTUAL LOCATION IS MAGU BEACH JUST NORTH OF MAGU ROCK
Backup-Enroute	03/20/2003 19:31:05	Andrea	3D52 3D22
ID	03/20/2003 19:31:05	Andrea	3D22 <3358>EDWIN TUAZON
Backup-Onscene	03/20/2003 19:31:37	Andrea	3C51 3C21
ID	03/20/2003 19:31:37	Andrea	3C21 <3220>BRENT FAST
Case	03/20/2003 19:32:16	Andrea	3D51 SO030008235 Assigned
Misc. Comment Coi	03/20/2003 19:32:37	Andrea	3C51, OIS/SUBJ DOWN WOUND TO HEAD/DOA
Misc. Comment Coi	03/20/2003 19:33:20	Andrea	CAR12, 10-6 SOCO
Misc. Comment Coi	03/20/2003 19:33:47	Andrea	3D52, 10-6 SOCO
Misc. Comment Coi	03/20/2003 19:33:56	Andrea	5G21, 10-6 SOCO
On Scene	03/20/2003 19:34:18	Andrea	CAR12
On Scene	03/20/2003 19:34:22	Andrea	5G23
Misc. Comment Coi	03/20/2003 19:36:16	Andrea	3DK, 10-6 SOCO
On Scene	03/20/2003 19:36:19	Andrea	3D52
Supplemental Inforr	03/20/2003 19:36:34	remy	TEXT:PER DEP SHIREMAN, CHP IS ER TO ASSIST WITH TRAFFIC CONTROL
Transfer	03/20/2003 19:36:36	ohn	@CDAREA:WEST-->TAC2
On Scene	03/20/2003 19:37:33	Andrea	3C51
On Scene	03/20/2003 19:37:36	Andrea	3C22
On Scene	03/20/2003 19:37:40	Andrea	3D51
On Scene	03/20/2003 19:37:44	Andrea	3D22
On Scene	03/20/2003 19:37:46	Andrea	3DK
Backup-Enroute	03/20/2003 19:38:45	Pat	3D51 5I
ID	03/20/2003 19:38:45	Pat	5I <1968>JOHN MILLER
On Scene	03/20/2003 19:39:01	Andrea	5I
Misc. Comment Coi	03/20/2003 19:39:59	Andrea	3S19, 10-6 SOCO

Status	Status Date	Entered By	Comments
Misc. Comment Coi	03/20/2003 19:40:14	Andrea	3C51, STOPPING TRAFFIC HEADING NORTH
Clear	03/20/2003 19:41:22	Andrea	3DK
On Scene	03/20/2003 19:42:41	Christy	3S19
Backup-Enroute	03/20/2003 19:44:42	Christy	5G10 5H16
ID	03/20/2003 19:44:42	Christy	5H16 <3318>WILLIAM AYUB
ID	03/20/2003 19:45:53	Christy	5H13 <1935>DEBORAH RUBRIGHT
Backup-Enroute	03/20/2003 19:45:53	Christy	5G10 5H13
Recontact	03/20/2003 19:47:11	Christy	3C21
Recontact	03/20/2003 19:47:11	Christy	5G11
Recontact	03/20/2003 19:47:11	Christy	5G21
Recontact	03/20/2003 19:47:11	Christy	5G23
Recontact	03/20/2003 19:47:11	Christy	CAR12
Recontact	03/20/2003 19:48:56	Christy	3C22
Recontact	03/20/2003 19:48:56	Christy	3C51
Recontact	03/20/2003 19:48:56	Christy	3D22
Recontact	03/20/2003 19:48:56	Christy	3D51
Recontact	03/20/2003 19:49:00	Christy	3D51
On Scene	03/20/2003 19:50:29	Andrea	5G10
Misc. Comment Coi	03/20/2003 19:57:48	Andrea	5G23, PIO ENR
Backup-Onscene	03/20/2003 19:58:21	Andrea	3C51 5H2
ID	03/20/2003 19:58:21	Andrea	5H2 <2622>MELISSA SMITH
Recontact	03/20/2003 20:00:21	Andrea	3D52
Recontact	03/20/2003 20:00:26	Andrea	5I
Backup-Enroute	03/20/2003 20:00:43	Andrea	3C51 5H17
ID	03/20/2003 20:00:43	Andrea	5H17 <2696>JOSE RIVERA
Misc. Comment Coi	03/20/2003 20:00:52	Andrea	5I, LIFT 33
On Scene OK	03/20/2003 20:01:23	Andrea	5G23
On Scene OK	03/20/2003 20:01:23	Andrea	5H2
On Scene OK	03/20/2003 20:01:23	Andrea	5I
On Scene OK	03/20/2003 20:01:23	Andrea	CAR12
On Scene OK	03/20/2003 20:01:23	Andrea	3C51
On Scene OK	03/20/2003 20:01:23	Andrea	3C21
On Scene OK	03/20/2003 20:01:23	Andrea	3C22
On Scene OK	03/20/2003 20:01:23	Andrea	3D22
On Scene OK	03/20/2003 20:01:23	Andrea	3D51
On Scene OK	03/20/2003 20:01:23	Andrea	3D52
On Scene OK	03/20/2003 20:01:23	Andrea	3S19
On Scene OK	03/20/2003 20:01:23	Andrea	5G10
On Scene OK	03/20/2003 20:01:23	Andrea	5G11
On Scene OK	03/20/2003 20:01:23	Andrea	5G21
On Scene OK	03/20/2003 20:01:29	Andrea	8J51
Transfer	03/20/2003 20:02:52	Andrea	@CDAREA:TAC2-->WEST
On Scene	03/20/2003 20:03:21	Andrea	5H16
Backup-Enroute	03/20/2003 20:04:22	Andrea	3C51 1114

Status	Status Date	Entered By	Comments
ID	03/20/2003 20:04:22	Andrea	1114 <2550>ERIC DOWD
On Scene	03/20/2003 20:07:45	Andrea	5H13
Misc. Comment Co	03/20/2003 20:08:41	Andrea	5G11, RD 3262 3C02 BEAT
On Scene	03/20/2003 20:14:19	amara	5H17
Backup-Enroute	03/20/2003 20:19:13	amara	3C51 5E2 5E5
ID	03/20/2003 20:19:13	amara	5E2 <3322>IAN F [REDACTED]
ID	03/20/2003 20:19:13	amara	5E5 <3832>ERIK K [REDACTED]
Backup-Onscene	03/20/2003 20:19:47	amara	3C51 5H1
ID	03/20/2003 20:19:47	amara	5H1 <1365>MICHAEL POWERS
Recontact	03/20/2003 20:25:49	amara	5H13
Recontact	03/20/2003 20:25:49	amara	5H16
Recontact	03/20/2003 20:25:49	amara	5H17
On Scene	03/20/2003 20:27:41	amara	1114
On Scene	03/20/2003 20:40:50	amara	5E2
On Scene	03/20/2003 20:40:50	amara	5E5
Recontact	03/20/2003 20:41:25	amara	1114
Recontact	03/20/2003 20:41:25	amara	5H1
Recontact	03/20/2003 20:54:41	amara	5E2
Recontact	03/20/2003 20:54:41	amara	5E5
Backup-Enroute	03/20/2003 21:00:54	amara	3C51 CAMCP
Clear	03/20/2003 21:17:03	amara	5G23
Backup-Enroute	03/20/2003 21:31:40	amara	3C51 1112
ID	03/20/2003 21:31:40	amara	1112 <1794>JAMES KENNEY
Clear	03/20/2003 21:49:19	amara	CAR12
On Scene	03/20/2003 22:00:53	amara	CAMCP
Recontact	03/20/2003 22:05:42	amara	1112
On Scene	03/20/2003 22:16:59	Christy	1112
Clear	03/20/2003 22:17:20	Christy	5G21
Misc. Comment Co	03/20/2003 22:24:12	Christy	8J51, REQ 8I TO 1198 W/ DIGITAL CAMERA
Recontact	03/20/2003 22:24:58	Christy	CAMCP
Backup-Enroute	03/20/2003 22:29:01	Christy	8J51 8I51
ID	03/20/2003 22:29:01	Christy	8I51 <3584>GARY NIEBERGALL
Recontact	03/20/2003 22:29:15	Christy	1112
Clear	03/20/2003 22:31:01	Christy	5G10
On Scene	03/20/2003 22:37:32	Christy	8I51
Clear	03/20/2003 22:44:16	Christy	5G11
Recontact	03/20/2003 22:50:04	Christy	8I51
Clear	03/20/2003 23:02:28	Christy	5H2
Change Location	03/20/2003 23:14:35	Christy	8J51 [REDACTED]
Change Location O	03/20/2003 23:24:52	Christy	8I51 [REDACTED]
On Scene	03/20/2003 23:28:26	Christy	8J51
Recontact	03/20/2003 23:42:23	Christy	8J51
Backup-Enroute	03/20/2003 23:45:10	Christy	3C51 8T
ID	03/20/2003 23:45:10	Christy	8T <2277>JOHN POPP

Status	Status Date	Entered By	Comments
Clear	03/20/2003 23:51:52	Christy	8J51 RPT
Clear	03/21/2003 00:00:26	Christy	8I51
On Scene	03/21/2003 00:37:28	Christy	8T
Recontact	03/21/2003 00:57:34	Christy	8T
Backup-Enroute	03/21/2003 01:23:09	Christy	3C22 3CR
ID	03/21/2003 01:23:09	Christy	3CR <2913>MARCO HINAHON
Misc. Comment Cor	03/21/2003 01:29:30	in	[REDACTED]
Misc. Comment	03/21/2003 01:31:15	Christy	.833, 1022 LAST CLEARANCE
Clear	03/21/2003 01:52:05	Christy	3D52
On Scene	03/21/2003 01:55:00	Christy	3CR
Clear	03/21/2003 02:03:25	Christy	5H13
Recontact	03/21/2003 02:31:05	Christy	3CR
Clear	03/21/2003 02:41:47	Christy	3CR
Clear	03/21/2003 02:44:34	Christy	5H16
Backup-Onscene	03/21/2003 03:00:49	Christy	3C22 3CR
ID	03/21/2003 03:00:49	Christy	3CR <3283> [REDACTED] PH MULROONEY
Recontact	03/21/2003 03:37:09	marara	3CR
Misc. Comment Cor	03/21/2003 03:39:08	in	[REDACTED]
Tow Request	03/21/2003 03:41:14	in	3CR OWLSOX YES, OWLSOXOWLS TOWING 8054853811
Backup-Enroute	03/21/2003 04:30:09	loria	CAMCP 3D23
ID	03/21/2003 04:30:09	loria	3D23 <2409>DAVID SPARKS <3096>PATRICK HARDY
On Scene	03/21/2003 04:42:59	loria	3D23
Change Location	03/21/2003 04:43:23	loria	3D23 800 S VICTORIA AV
Clear	03/21/2003 04:50:39	loria	3CR RPT
Clear	03/21/2003 04:50:42	loria	3C21 RPT
Clear	03/21/2003 04:51:10	loria	3S19
Clear	03/21/2003 04:51:14	loria	CAMCP
Clear	03/21/2003 04:51:21	loria	8T
Clear	03/21/2003 04:51:35	loria	1112 RPT
Clear	03/21/2003 04:51:35	loria	1114 RPT
Clear	03/21/2003 04:51:35	loria	3C22 RPT
Clear	03/21/2003 04:51:35	loria	3C51 RPT
Clear	03/21/2003 04:51:35	loria	3D22 RPT
Clear	03/21/2003 04:51:35	loria	3D23 RPT
Clear	03/21/2003 04:51:35	loria	3D51 RPT
Clear	03/21/2003 04:51:35	loria	5E2 RPT
Clear	03/21/2003 04:51:35	loria	5E5 RPT
Clear	03/21/2003 04:51:35	loria	5H1 RPT
Clear	03/21/2003 04:51:35	loria	5H17 RPT
Clear	03/21/2003 04:51:35	loria	5I RPT
Close	03/21/2003 04:51:35	loria	5I RPT

INCIDENT HISTORY DETAIL: S030790833

INITIATE:	18:42:48	03/20/03	CALL NUMBER:	S0833
ENTRY:	18:49:18		CURRENT STATUS:	CLOSED
DISPATCH:	18:51:23		PRIMARY UNIT:	8J51
OPEN SCENE:	19:05:46		CASE NUMBER:	SO0300008235
CLOSE:	04:51:35	03/21/03	DISPOSITION:	RPT

LOCATION COMMENTS:

DAREA: WEST
 BEAT: 8A01 MAP PAGE: 523-H2 TYPE: SUICSU SUICIDAL SUBJECT
 RD: 8003 PRIORITY: E (IN-PROGRESS)

18:49:18 CT08 ENTRY

18:49:18 CT08 E911

18:50:37 CT08 SUPP

18:51:23 CR04 DISP-ENR 8J51

18:51:23 CR04 ID 8J51 <3267>BRENT JOHNSON

18:52:42 CR04 BACK-ER 8J51 8B11

18:52:42 CR04 ID 8B11 <3612>WILLIAM HOLLOWELL

18:52:58 CT09 MISCX LASO ADV

18:54:56 CR04 MISCX 8J51, INFO BCAST TO WEST COUNTY UNITS

18:55:06 CT08 SUPP TEXT:CHP ADV

18:55:59 CR04 MISCX 8J51,

18:56:31 CR05 MISCX 8J51, INFO BCASTED TO EV UNITS

18:57:00 CT09 MISCX CAM LATE CARS ADVISED FOR BREIFING

18:59:03 CR04 CLEAR 8B11

18:59:05 CR04 BACK-ER 8J51 8B11

18:59:05 CR04 ID 8B11 <3612>WILLIAM HOLLOWELL

18:59:09 CR04 BACK-ER 8J51 8C11

18:59:09 CR04 ID 8C11 <1541>NOEL SANJOSE

19:00:38 CT08 SUPP TEXT:PER RP SUBJ POSS ENR TO MUGU ROCK/ RP ATTEMPTING TO CONTACT ONSTAR FOR A LOC OF THE

19:01:03 CR04 BACK-ER 8J51 3C51

19:01:03 CR04 ID 3C51 <2743>JASON STEPHENS

19:02:11 CR04 CHGLOC 3C51 MUGU ROCK

19:05:46 CR04 ONSCENE 8B11

19:05:48 CR04 ONSCENE 8C11

19:07:53 CR04 ONSCENE 8J51

19:08:04 CR03 MISCX HARDY AT D STATION ADV'D OF CALL INFO/OFFICER SAFETY

19:08:44 CR04 MISCX 8J51, RP UNABLE TO ACTIVATE ONSTAR FROM THE HOUSE

19:09:47 CR04 BACK-ER 3C51 3D51

19:09:47 CR04 ID 3D51 <3415>STEVEN CERIO

19:09:55 CR04 MISCX 3C51, SO CO

19:14:13 CR04 MISCX 3C51, 1/4 MILE

19:14:43 CR04 MISCX 3D51, 1/4 MILE PAST MUGU ROCK

19:14:52 CR04 BACK-ER 3C51 5G21

19:14:52 CR04 ID 5G21 <3126>MICHAEL MARCO <2347>WILLIAM SCHIERMAN

19:14:59 CR04 MISCX 5G21, RESPONDING CODE

19:15:12 CR04 MISCX 3C51, HAS THE VEH 1/4 PAST MUGU ROCK

19:16:15 CT07 BACK-ER 3C51 8G41, FOR CIT

19:16:15 CT07 ID 8G41 <3354>BEATRICE NORTON

19:16:31 CR04 MISCX 3C51, ATTEMPTING TO MOVE

19:16:36 CR04 BACK-ER 3C51 5G11

19:16:36 CR04 ID 5G11 <3419>MICHAEL MCCONVILLE <1312>ALLAN HEERSCHE

19:17:19 CR04 MISCX 3C51, NEG ON ILLEGAL INTERVENTION

19:17:37 CR04 BACK-ER 3C51 3C22

19:17:37 CR04 ID 3C22 <3283>JOSEPH MULROONEY

19:17:42 CR04 MISCX 3C22, RES CODE

19:17:46 CR04 MISCX 5G21, RES CODE

19:18:43 CR04 MISCX 3D51, SUBJ IN VEH UNCOOPERATIVE/SUBJ RESPONSIVE

19:18:55 CR04 BACK-ER 3D51 3DK

19:48:56 CR04 RCONTACT 3D22
19:48:56 CR04 RCONTACT 3D51
19:49:00 CR04 RCONTACT 3D51
19:50:29 CR04 ONSCENE 5G10
19:57:48 CR04 MISCX 5G23, PIO ENR
19:58:21 CR04 BACK-OS 3C51 5H2
19:58:21 CR04 ID 5H2 <2622>MELISSA SMITH
20:00:21 CR04 RCONTACT 3D52
20:00:26 CR04 RCONTACT 5I
20:00:43 CR04 BACK-ER 3C51 5H17
20:00:43 CR04 ID 5H17 <2696>JOSE RIVERA
20:00:52 CR04 MISCX 5I, LIFT 33
20:01:23 CR04 ONSCENOK 3C21
20:01:23 CR04 ONSCENOK 3C22
20:01:23 CR04 ONSCENOK 3D22
20:01:23 CR04 ONSCENOK 3D51
20:01:23 CR04 ONSCENOK 3D52
20:01:23 CR04 ONSCENOK 3S19
20:01:23 CR04 ONSCENOK 5G10
20:01:23 CR04 ONSCENOK 5G11
20:01:23 CR04 ONSCENOK 5G21
20:01:23 CR04 ONSCENOK 5G23
20:01:23 CR04 ONSCENOK 5H2
20:01:23 CR04 ONSCENOK 5I
20:01:23 CR04 ONSCENOK CAR12
20:01:23 CR04 ONSCENOK 3C51
20:01:29 CR04 ONSCENOK 8J51
20:02:52 CR04 TRANSFER @CDAREA:TAC2-->WEST
20:03:21 CR04 ONSCENE 5H16
20:04:22 CR04 BACK-ER 3C51 11I4
20:04:22 CR04 ID 11I4 <2550>ERIC DOWD
20:07:45 CR04 ONSCENE 5H13
20:08:41 CR04 MISCX 5G11, RD 3262 3C02 BEAT
20:14:19 CR04 ONSCENE 5H17
20:19:13 CR04 BACK-ER 3C51 5E2 5E5
20:19:13 CR04 ID 5E2 <3322>IAN [REDACTED]
20:19:13 CR04 ID 5E5 <3832>ERIK [REDACTED]
20:19:47 CR04 BACK-OS 3C51 5H1
20:19:47 CR04 ID 5H1 <1365>MICHAEL POWERS
20:25:49 CR04 RCONTACT 5H13
20:25:49 CR04 RCONTACT 5H16
20:25:49 CR04 RCONTACT 5H17
20:27:41 CR04 ONSCENE 11I4
20:40:50 CR04 ONSCENE 5E2
20:40:50 CR04 ONSCENE 5E5
20:41:25 CR04 RCONTACT 11I4
20:41:25 CR04 RCONTACT 5H1
20:54:41 CR04 RCONTACT 5E2
20:54:41 CR04 RCONTACT 5E5
21:00:54 CR04 BACK-ER 3C51 CAMCP
21:17:03 CR04 CLEAR 5G23
21:31:40 CR04 BACK-ER 3C51 11I2
21:31:40 CR04 ID 11I2 <1794>JAMES KENNEY
21:49:19 CR04 CLEAR CAR12
22:00:53 CR04 ONSCENE CAMCP
22:05:42 CR04 RCONTACT 11I2
22:16:59 CR03 ONSCENE 11I2
22:17:20 CR03 CLEAR 5G21
22:24:12 CR03 MISCX 8J51, REQ 8I TO 1198 W/ DIGITAL CAMERA
22:24:58 CR03 RCONTACT CAMCP
22:29:01 CR03 BACK-ER 8J51 8I51
22:29:01 CR03 ID 8I51 <3584>GARY NIEBERGALL
22:29:15 CR03 RCONTACT 11I2
22:31:01 CR03 CLEAR 5G10
22:37:32 CR03 ONSCENE 8I51
22:44:16 CR03 CLEAR 5G11
22:50:04 CR03 RCONTACT 8I51
23:02:28 CR03 CLEAR 5H2
23:14:35 CR03 CHGLOC 8J51 [REDACTED]
23:24:52 CR03 CHGLOCOS 8I51 [REDACTED]
23:28:26 CR03 ONSCENE 8J51

23:42:23 CR03 RCONTACT 8J51
 23:45:10 CR03 BACK-ER 3C51 8T
 23:45:10 CR03 ID 8T <2277>JOHN POPP
 23:51:52 CR03 CLEAR 8J51 RPT

03/21/03
 00:00:26 CR03 CLEAR 8I51
 00:37:28 CR03 ONSCENE 8T
 00:57:34 CR03 RCONTACT 8T
 01:23:09 CR03 BACK-ER 3C22 3CR
 01:23:09 CR03 ID 3CR <2913>MARCO HINAHON
 01:29:30 CR02 MISCX 3D22 [REDACTED]
 01:31:15 CR03 MISC .833, 1022 LAST CLEARANCE
 01:52:05 CR03 CLEAR 3D52
 01:55:00 CR03 ONSCENE 3CR
 02:03:25 CR03 CLEAR 5H13
 02:31:05 CR03 RCONTACT 3CR
 02:41:47 CR03 CLEAR 3CR
 02:44:34 CR03 CLEAR 5H16
 03:00:49 CR03 BACK-OS 3C22 3CR
 03:00:49 CR03 ID 3CR <3283>JOSEPH MULROONEY
 03:37:09 CR04 RCONTACT 3CR
 03:39:08 CR02 MISCX 3C22, [REDACTED]
 03:41:14 CR02 TOWRQST 3CR OWLSOX YES, OWLSOXOWLS TOWING 8054853811
 04:30:09 CR05 BACK-ER CAMCP 3D23
 04:30:09 CR05 ID 3D23 <2409>DAVID SPARKS <3096>PATRICK HARDY
 04:42:59 CR05 ONSCENE 3D23
 04:43:23 CR05 CHGLOC 3D23 800 S VICTORIA AV
 04:50:39 CR05 CLEAR 3CR RPT
 04:50:42 CR05 CLEAR 3C21 RPT
 04:51:10 CR05 CLEAR 3S19
 04:51:14 CR05 CLEAR CAMCP
 04:51:21 CR05 CLEAR 8T
 04:51:35 CR05 CLEAR 11I2 RPT
 04:51:35 CR05 CLEAR 11I4 RPT
 04:51:35 CR05 CLEAR 3C22 RPT
 04:51:35 CR05 CLEAR 3C51 RPT
 04:51:35 CR05 CLEAR 3D22 RPT
 04:51:35 CR05 CLEAR 3D23 RPT
 04:51:35 CR05 CLEAR 3D51 RPT
 04:51:35 CR05 CLEAR 5E2 RPT
 04:51:35 CR05 CLEAR 5E5 RPT
 04:51:35 CR05 CLEAR 5H1 RPT
 04:51:35 CR05 CLEAR 5H17 RPT
 04:51:35 CR05 CLEAR 5I RPT
 04:51:35 CR05 CLOSE 5I RPT

OPERATOR ASSIGNMENTS: CT08 3335
 CR04 4097
 CT09 3966
 CR05 4067
 CR03 4169
 CT07 4075
 CR02 2829
 AS OF 19:21:14: CT08 4067
 AS OF 19:30:46: CT09 3474
 SUP1 4225
 AS OF 19:42:41: CR04 4067
 AS OF 19:50:29: CR04 4097
 AS OF 20:14:19: CR04 4075
 AS OF 22:16:59: CR03 4067
 AS OF 04:30:09: CR05 1196



Unit	Role	Officer ID	Officer Name
	Status	Status Date	Comments
3DR	Backup	2555	Hardy, Scott
	Dispatch	03/20/2003 19:18:55	030790833 E/SUICSU 3D51 MUGU ROCK
	Cleared	03/20/2003 19:41:22	3DK
	Arrival	03/20/2003 19:37:46	
	Enroute	03/20/2003 19:18:55	030790833 E/SUICSU 3D51 MUGU ROCK
8B11	Backup	3612	Hollowell, William
	Dispatch	03/20/2003 18:52:42	
	Pre-Empt	03/20/2003 18:59:03	8B11
	Cleared	03/20/2003 18:59:03	8B11
	Enroute	03/20/2003 18:52:42	
	Dispatch	03/20/2003 18:59:05	
	Cleared	03/20/2003 19:20:05	8B11
	Arrival	03/20/2003 19:05:46	
	Enroute	03/20/2003 18:59:05	
8C11	Backup	1541	San [REDACTED] Noel
	Enroute	03/20/2003 18:59:09	
	Cleared	03/20/2003 19:20:10	8C11
	Dispatch	03/20/2003 18:59:09	
	Arrival	03/20/2003 19:05:48	
8G41	Backup	3354	Norton, ?
	Cleared	03/20/2003 19:27:55	8G41
	Enroute	03/20/2003 19:19:20	030790833 E/SUICSU 3D51 MUGU ROCK
	Cleared	03/20/2003 19:19:13	8G41
	Pre-Empt	03/20/2003 19:27:55	8G41
	Dispatch	03/20/2003 19:16:15	030790833 E/SUICSU 3C51 MUGU ROCK, FOR CIT
	Dispatch	03/20/2003 19:19:20	030790833 E/SUICSU 3D51 MUGU ROCK
	Pre-Empt	03/20/2003 19:19:13	8G41
	Enroute	03/20/2003 19:16:15	030790833 E/SUICSU 3C51 MUGU ROCK, FOR CIT
5G11	Backup	3419	Mc connville, Michael
	Enroute	03/20/2003 19:16:36	030790833 E/SUICSU 3C51 MUGU ROCK
	On Scene OK	03/20/2003 20:01:23	
	Cleared	03/20/2003 22:44:16	5G11
	Arrival	03/20/2003 19:23:32	
	Dispatch	03/20/2003 19:16:36	030790833 E/SUICSU 3C51 MUGU ROCK
5G11	Backup	1312	Heersche, Alan
	Enroute	03/20/2003 19:16:36	030790833 E/SUICSU 3C51 MUGU ROCK
	On Scene OK	03/20/2003 20:01:23	
	Dispatch	03/20/2003 19:16:36	030790833 E/SUICSU 3C51 MUGU ROCK
	Arrival	03/20/2003 19:23:32	

Unit	Role	Officer ID	Officer Name
	Status	Status Date	Comments
5G11	Backup	1312	Heersche, Alan
	Cleared	03/20/2003 22:44:16	5G11
5G23	Backup	2605	Clancy, Kevin
	Cleared	03/20/2003 21:17:03	5G23
	Arrival	03/20/2003 19:34:22	
	On Scene OK	03/20/2003 20:01:23	
	Dispatch	03/20/2003 19:22:08	030790833 E/SUICSU 3C51 MUGU ROCK
	Enroute	03/20/2003 19:22:08	030790833 E/SUICSU 3C51 MUGU ROCK
5G23	Backup	3544	Young, Matthew
	Arrival	03/20/2003 19:34:22	
	Cleared	03/20/2003 21:17:03	5G23
	Enroute	03/20/2003 19:22:08	030790833 E/SUICSU 3C51 MUGU ROCK
	On Scene OK	03/20/2003 20:01:23	
	Dispatch	03/20/2003 19:22:08	030790833 E/SUICSU 3C51 MUGU ROCK
3C51	Backup	2743	Stephens, Jason
	Cleared	03/21/2003 04:51:35	3C51 RPT
	Dispatch	03/20/2003 19:01:03	
	Enroute	03/20/2003 19:01:03	
	On Scene OK	03/20/2003 20:01:23	
	Arrival	03/20/2003 19:37:33	
3D51	Backup	3415	Cerio, Steve
	Dispatch	03/20/2003 19:09:47	030790833 E/SUICSU 3C51 MUGU ROCK
	Enroute	03/20/2003 19:09:47	030790833 E/SUICSU 3C51 MUGU ROCK
	Arrival	03/20/2003 19:37:40	
	Cleared	03/21/2003 04:51:35	3D51 RPT
	On Scene OK	03/20/2003 20:01:23	
3D52	Backup	3018	
	Cleared	03/21/2003 01:52:05	3D52
	Arrival	03/20/2003 19:36:19	
	On Scene OK	03/20/2003 20:01:23	
	Dispatch	03/20/2003 19:30:32	030790833 E/SUICSU 3C51 MUGU ROCK
	Enroute	03/20/2003 19:30:32	030790833 E/SUICSU 3C51 MUGU ROCK
8I51	Backup	3584	Niebergall, Gary
	Dispatch	03/20/2003 22:29:01	
	Enroute	03/20/2003 22:29:01	
	Arrival	03/20/2003 22:37:32	
	Cleared	03/21/2003 00:00:26	8I51
8J51	Primary	3267	Johnson, Brent
	On Scene OK	03/20/2003 20:01:29	
	Cleared	03/20/2003 23:51:52	8J51 RPT

Unit	Role	Officer ID	Officer Name
	Status	Status Date	Comments
8J51	Primary	3267	Johnson, Brent
	Dispatch	03/20/2003 18:51:23	
	Arrival	03/20/2003 19:07:53	
	Enroute	03/20/2003 18:51:23	
5G21	Backup	3126	Marco, M
	Cleared	03/20/2003 22:17:20	5G21
	Dispatch	03/20/2003 19:14:52	030790833 E/SUICSU 3C51 MUGU ROCK
	On Scene OK	03/20/2003 20:01:23	
	Enroute	03/20/2003 19:14:52	030790833 E/SUICSU 3C51 MUGU ROCK
	Arrival	03/20/2003 19:24:49	
5G21	Backup	2347	Schierman, B
	Enroute	03/20/2003 19:14:52	030790833 E/SUICSU 3C51 MUGU ROCK
	Cleared	03/20/2003 22:17:20	5G21
	Dispatch	03/20/2003 19:14:52	030790833 E/SUICSU 3C51 MUGU ROCK
	On Scene OK	03/20/2003 20:01:23	
	Arrival	03/20/2003 19:24:49	
5G10	Backup	1998	Lareva, David
	Cleared	03/20/2003 22:31:01	5G10
	Enroute	03/20/2003 19:27:53	030790833 E/SUICSU 3C51 MUGU ROCK
	Arrival	03/20/2003 19:50:29	
	On Scene OK	03/20/2003 20:01:23	
	Dispatch	03/20/2003 19:27:53	030790833 E/SUICSU 3C51 MUGU ROCK
1114	Backup	2550	Dowd, Eric
	Cleared	03/21/2003 04:51:35	1114 RPT
	Arrival	03/20/2003 20:27:41	
	Dispatch	03/20/2003 20:04:22	030790833 E/SUICSU 3C51 MUGU ROCK
	Enroute	03/20/2003 20:04:22	030790833 E/SUICSU 3C51 MUGU ROCK
3C21	Backup	3220	Fast, Brent
	Enroute	03/20/2003 19:31:37	030790833 E/SUICSU 3C51 MUGU ROCK
	Cleared	03/21/2003 04:50:42	3C21 RPT
	On Scene OK	03/20/2003 20:01:23	
	Arrival	03/20/2003 19:31:37	030790833 E/SUICSU 3C51 MUGU ROCK
	Dispatch	03/20/2003 19:31:37	030790833 E/SUICSU 3C51 MUGU ROCK
3C22	Backup	2913	Hinahon, Marco
	Arrival	03/20/2003 19:37:36	
	Cleared	03/21/2003 04:51:35	3C22 RPT
	On Scene OK	03/20/2003 20:01:23	
	Dispatch	03/20/2003 19:17:37	030790833 E/SUICSU 3C51 MUGU ROCK
	Enroute	03/20/2003 19:17:37	030790833 E/SUICSU 3C51 MUGU ROCK
3C22	Backup	3283	Mulrooney, Joseph
	Arrival	03/20/2003 19:37:36	

Unit	Role	Officer ID	Officer Name
	Status	Status Date	Comments
3C22	Backup	3283	Mulrooney, Joseph
	Cleared	03/21/2003 04:51:35	3C22 RPT
	On Scene OK	03/20/2003 20:01:23	
	Dispatch	03/20/2003 19:17:37	030790833 E/SUICSU 3C51 MUGU ROCK
	Enroute	03/20/2003 19:17:37	030790833 E/SUICSU 3C51 MUGU ROCK
3D22	Backup	3358	Tuazon, Edwin
	Cleared	03/21/2003 04:51:35	3D22 RPT
	Arrival	03/20/2003 19:37:44	
	On Scene OK	03/20/2003 20:01:23	
	Dispatch	03/20/2003 19:31:05	030790833 E/SUICSU 3D52 MUGU ROCK
	Enroute	03/20/2003 19:31:05	030790833 E/SUICSU 3D52 MUGU ROCK
3D23	Backup	3096	Hardy, Patrick
	Cleared	03/21/2003 04:51:35	3D23 RPT
	Arrival	03/21/2003 04:42:59	
	Dispatch	03/21/2003 04:30:09	030790833 E/SUICSU CAMCP MUGU ROCK
	Enroute	03/21/2003 04:30:09	030790833 E/SUICSU CAMCP MUGU ROCK
3D23	Backup	2409	Sparks, D
	Dispatch	03/21/2003 04:30:09	030790833 E/SUICSU CAMCP MUGU ROCK
	Enroute	03/21/2003 04:30:09	030790833 E/SUICSU CAMCP MUGU ROCK
	Arrival	03/21/2003 04:42:59	
	Cleared	03/21/2003 04:51:35	3D23 RPT
3S19	Backup	2063	Hanley, Harold
	Arrival	03/20/2003 19:42:41	
	Cleared	03/21/2003 04:51:10	3S19
	On Scene OK	03/20/2003 20:01:23	
	Dispatch	03/20/2003 19:27:34	030790833 E/SUICSU 3C51 MUGU ROCK
	Enroute	03/20/2003 19:27:34	030790833 E/SUICSU 3C51 MUGU ROCK
5E2	Backup	3322	██████, Ian
	Cleared	03/21/2003 04:51:35	5E2 RPT
	Dispatch	03/20/2003 20:19:13	030790833 E/SUICSU 3C51 MUGU ROCK
	Enroute	03/20/2003 20:19:13	030790833 E/SUICSU 3C51 MUGU ROCK
	Arrival	03/20/2003 20:40:50	
5E5	Backup	3832	██████, Erik
	Dispatch	03/20/2003 20:19:13	030790833 E/SUICSU 3C51 MUGU ROCK
	Enroute	03/20/2003 20:19:13	030790833 E/SUICSU 3C51 MUGU ROCK
	Arrival	03/20/2003 20:40:50	
	Cleared	03/21/2003 04:51:35	5E5 RPT
5H1	Backup	1365	Powers, Michael
	Cleared	03/21/2003 04:51:35	5H1 RPT
	Arrival	03/20/2003 20:19:47	030790833 E/SUICSU 3C51 MUGU ROCK
	Dispatch	03/20/2003 20:19:47	030790833 E/SUICSU 3C51 MUGU ROCK
	Enroute	03/20/2003 20:19:47	030790833 E/SUICSU 3C51 MUGU ROCK

Unit	Role	Officer ID	Officer Name
	Status	Status Date	Comments
5H13	Backup	1935	Rubright, D
	Cleared	03/21/2003 02:03:25	5H13
	Dispatch	03/20/2003 19:45:53	030790833 E/SUICSU 5G10 MUGU ROCK
	Enroute	03/20/2003 19:45:53	030790833 E/SUICSU 5G10 MUGU ROCK
	Arrival	03/20/2003 20:07:45	
5H16	Backup	3318	Ayub, William
	Cleared	03/21/2003 02:44:34	5H16
	Dispatch	03/20/2003 19:44:42	030790833 E/SUICSU 5G10 MUGU ROCK
	Enroute	03/20/2003 19:44:42	030790833 E/SUICSU 5G10 MUGU ROCK
	Arrival	03/20/2003 20:03:21	
5H17	Backup	2696	Rivera, Jose
	Cleared	03/21/2003 04:51:35	5H17 RPT
	Dispatch	03/20/2003 20:00:43	030790833 E/SUICSU 3C51 MUGU ROCK
	Enroute	03/20/2003 20:00:43	030790833 E/SUICSU 3C51 MUGU ROCK
	Arrival	03/20/2003 20:14:19	
5H2	Backup	2622	Smith, Melissa
	Cleared	03/20/2003 23:02:28	5H2
	Arrival	03/20/2003 19:58:21	030790833 E/SUICSU 3C51 MUGU ROCK
	Dispatch	03/20/2003 19:58:21	030790833 E/SUICSU 3C51 MUGU ROCK
	Enroute	03/20/2003 19:58:21	030790833 E/SUICSU 3C51 MUGU ROCK
	On Scene OK	03/20/2003 20:01:23	
5I	Backup	1968	Miller, John
	Dispatch	03/20/2003 19:38:45	030790833 E/SUICSU 3D51 MUGU ROCK
	Enroute	03/20/2003 19:38:45	030790833 E/SUICSU 3D51 MUGU ROCK
	Arrival	03/20/2003 19:39:01	
	Cleared	03/21/2003 04:51:35	5I RPT
	On Scene OK	03/20/2003 20:01:23	
CAMCP	Backup		
	Arrival	03/20/2003 22:00:53	
	Cleared	03/21/2003 04:51:14	CAMCP
	Dispatch	03/20/2003 21:00:54	030790833 E/SUICSU 3C51 MUGU ROCK
	Enroute	03/20/2003 21:00:54	030790833 E/SUICSU 3C51 MUGU ROCK
CAR12	Backup	1186	Tennessee, David
	Arrival	03/20/2003 19:34:18	
	Cleared	03/20/2003 21:49:19	CAR12
	Dispatch	03/20/2003 19:22:23	
	Enroute	03/20/2003 19:22:23	
	Dispatch	03/20/2003 19:22:23	030790833 E/SUICSU 3C51 MUGU ROCK
	Enroute	03/20/2003 19:22:23	030790833 E/SUICSU 3C51 MUGU ROCK
On Scene OK	03/20/2003 20:01:23		
11I2	Backup	1794	Kenney, James
	Dispatch	03/20/2003 21:31:40	030790833 E/SUICSU 3C51 MUGU ROCK

Unit	Role	Officer ID	Officer Name
	Status	Status Date	Comments
1112	Backup	1794	Kenney, James
	Enroute	03/20/2003 21:31:40	030790833 E/SUICSU 3C51 MUGU ROCK
	Arrival	03/20/2003 22:16:59	
	Cleared	03/21/2003 04:51:35	1112 RPT
8T	Backup	2277	Popp, John
	Dispatch	03/20/2003 23:45:10	030790833 E/SUICSU 3C51 MUGU ROCK
	Enroute	03/20/2003 23:45:10	030790833 E/SUICSU 3C51 MUGU ROCK
	Arrival	03/21/2003 00:37:28	
	Cleared	03/21/2003 04:51:21	8T
3CR	Backup	2913	Hinahon, Marco
	Dispatch	03/21/2003 01:23:09	030790833 E/SUICSU 3C22 MUGU ROCK
	Enroute	03/21/2003 01:23:09	030790833 E/SUICSU 3C22 MUGU ROCK
	Arrival	03/21/2003 01:55:00	
	Cleared	03/21/2003 02:41:47	3CR
3CR	Backup	3283	Mulrooney, Joseph
	Arrival	03/21/2003 03:00:49	030790833 E/SUICSU 3C22 MUGU ROCK
	Dispatch	03/21/2003 03:00:49	030790833 E/SUICSU 3C22 MUGU ROCK
	Enroute	03/21/2003 03:00:49	030790833 E/SUICSU 3C22 MUGU ROCK
	Cleared	03/21/2003 04:50:39	3CR RPT

Call Nbr: 030790833

RB Nbr: 030008235

Date / Times

E911: 03/20/2003 18:49:18	Received: 03/20/2003 18:42:48	Entered: 03/20/2003 18:49:18
Dispatch: 03/20/2003 18:51:23	Enroute: 03/20/2003 18:51:23	Arrival: 03/20/2003 19:05:46
On Scene OK: 03/20/2003 20:01:23	Cleared: 03/21/2003 04:51:35	RMS Xfer: 03/20/2003 21:04:06

Original Call Type:

Origin: Residence

Premise Hazard:

Priority: Emergency

In Progress: No

Activity Catch Up: No

Dup Of Call:

Override: No

Out Of Service: No

Prior Calls:

Entry ID: 3335

U

Dispatch ID: 4097

Andrea

ALERT/RMS Converted CFS Data

EMS / Fire

EMS Call Nbr:

Fire Call Nbr:

Fire Dist:

03-8235
OFFICER'S INVOLVED SHOOTING
NANCY PEARLMAN

PROGRESS LOG

- 3-20-2003 Respond to crime scene.
Crime scene investigation
Deputy Cerio interview
- 3-21-2003 Reports
Phone interview with suspect' [REDACTED]
- 2-24-03 Inspected suspect/officer's vehicles at crime lab.
Photos of cars
Paints transfer obtain from both cars.
Note: Two bullets hit L/R rim & one bullet hit R/F rim/tire.
Property removed from suspect's car & given to husband (Powers)
- 3-25-2003 Reports
Lab requests for weapons/casing comparison
Received crime scene diagram from Popp (Good job).
E-mail from Capt. Fadler concerning [REDACTED] (neighbor)
- 3-26-2003 Met [REDACTED] at garage. Retrieved micro tape from Ciero recorder and made copy.
[REDACTED] advised tires checked for bullets. Bullets exited all tires.
Photos from patrol camera/ video to be copied.
Note: Check operations of all vehicles...lights etc.
[REDACTED] confirm bullet strikes on tires for transfers...positive for bullets.
Submitted firearm lab request.
Spoke with [REDACTED] by telephone...did not want to talk
Spoke with [REDACTED] by telephone...advised car will be release after review and ok by DA office.
- 3-27-2003 Reports
- 3-28-2003 Reports
Review Cerio's micro-cassette recording
Submit lab requests
- 3-29-2003 Report Writing

3-31-2003 Reports
Contact BI ref: tires / fender

4-1-2003 Reports
Review tapes
Copy original tapes
Property reports

4-2-03 Removed seals on doors.
Unit lights checked / all operating
Remove fender/panel/bumper from patrol unit at body shop
Unit released to body shop for repairs and final release to duty

4-3-03 Reports

4-7-03 Suspect's vehicle towed from Crime Lab to Todd Road Jail for
storage pending DA review.

4-8-03 Received Medical Examiner's report

4-10-03 Photographed handguns and ammo by BI
Reports

4-11-03 Reports

4-15-03 Reports.
Note: Rivera's reports indicates Stephens normally carries 14
rounds in the magazine and one chambered which coincide with
the four shell casing found near Stephens' and Cerio's units.

4-16-03 Met with Cerio and LDF attorney. reviewed diagrams.

4-17-03 Interview firemen/paramedics from Pt. Mugu Federal Fire Agency.
Reports.

4-21-03 Reviewed and booked video tapes
1. Scene
2. Cerio's walk through interview with M.C. investigators.
Booked audio tape / firemen's interviews

From: Mike Powers
To: Montagna, Ernie
Date: 3/25/03 3:29PM
Subject: Nancy Pearlman's FBI affiliation

I spoke to Kevin [REDACTED] at the Ventura FBI Office today. He told me that Nancy Pearlman [REDACTED]

[REDACTED]

Mike

CC: [REDACTED] Kelly

From: [REDACTED]
To: Kelly [REDACTED]
Date: 3/25/03 7:59AM
Subject: Pearlman OIS

[REDACTED] called me this morning re the Pearlman matter [REDACTED] and the two families are acquaintances.

About 5 days before her death, Nancy (Mrs.) Pearlman called the [REDACTED] from the [REDACTED] residence. She was upset, advised that [REDACTED] was taking off for London on a trip with his girlfriend [REDACTED]. Nancy asked [REDACTED] to get the name of a good divorce attorney for her.

The [REDACTED] family returned from a weekend trip on Sunday afternoon, and [REDACTED] pulled into their driveway, with various relatives of Nancy in the vehicle, and advised that Nancy had been shot by Deputies, after he had called them to advise Nancy was acting irrationally.

It is [REDACTED] opinion that Nancy Pearlman was not at all as unbalanced as the husband is trying to portray, but that he may well have been "pushing her buttons." [REDACTED] is worth millions, and a divorce would have been very expensive.

[REDACTED]

If you want info direct from [REDACTED]

CC: [REDACTED]